

# CMI-CATC60A-01-501

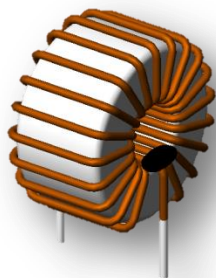

## Picture



## Features

- ▶ Excellent High Current
- ▶ Low Magnetic DCR
- ▶ High Efficiency and Frequency

## Applications

- ▶ Car Audio AMP, Car Power Inverter, Various Kinds SMPS

## Dimension (Unit:mm)

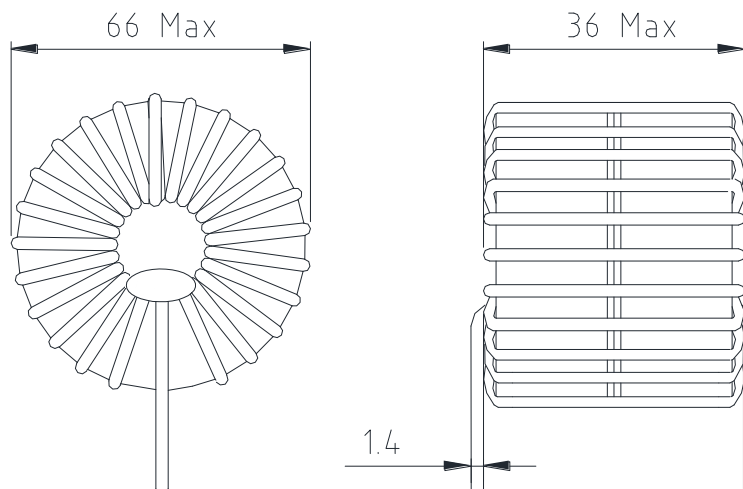

## Specifications

Part No.	Inductance (μH)	Tolerance (±)	Rated Current Isat Max.(A)	Test Frequency (Hz)
CMC-CATC60A-01-501	500	25%	20	100k

- Storage temperature range : -25 °c ~ +105 °c
- Operating Temperature Range(including self temperature) : -40 °c ~ +130 °c
- Isat : L drop 30%

Ilisan Sales Office (KOREA) +82)31-904-1444  
 Shenzhen Sales Office (CHINA) +86)755-8663-6929  
 Hungary Sales office (EUROPE) +36)30-913-7706

H.K Sales Office (HONGKONG) +852)2711-5551  
 LA Sales Office (USA) +1)866-446-3586

▪ You can also contact us by e-mail : [coilmaster@coilmaster.com](mailto:coilmaster@coilmaster.com)

- All specifications are subject to change without notice.
- Update date : 2018.03.26

[www.coilmaster.com](http://www.coilmaster.com)