

# CME-CGMCB160808K-SERIES

## Features

- ▶ The complete magnetic shielded structure minimizes crosstalk.
- ▶ It is ideal for high-speed signal lines because it targets high-speed lines and Provides significant impedance in a wide frequency range.
- ▶ The GMCB series is similar to EBMF series at frequency below 100MHz. However at 1 GHz, the impedance is 3 times larger
- ▶ It realizes high impedance at 1 GHz and is suitable for noise suppression on digital ranging from 500 MHz to GHz



## Applications

- ▶ Mother board, Tablet PC, Notebook, Desktop computers and peripheral equipment / DSC, DVC, LCD TV, Set top box / Digital communication equipment / Various automotive electronics / Various power line of electronic equipment

## Dimension (Unit:mm)

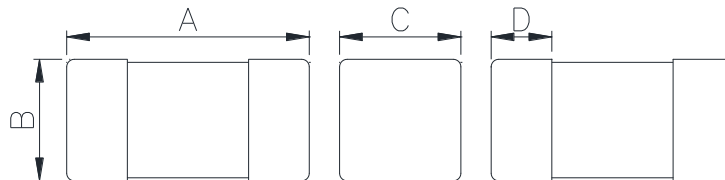

A	B	C	D
1.6±0.15	0.8±0.15	0.8±0.15	0.4±0.2

## Land Pattern (Unit:mm)

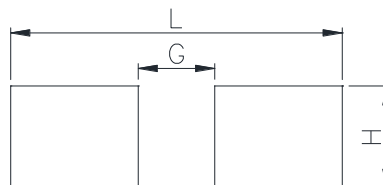

L	G	H
2.6	0.6	0.8

- You can also contact us by e-mail : [coilmaster@coilmaster.com](mailto:coilmaster@coilmaster.com)
- All specifications are subject to change without notice.
- Update date : 2023.03.29

## Regulation of part number

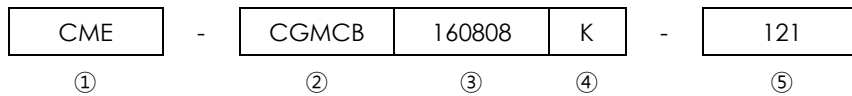

- ① CoilMaster's initial
- ② Product Series Name
- ③ Core Size (unit:mm)
- ④ Material Code
- ⑤ Normal Impedance (121 : 120 ohm)

## Specifications

Part Number	Impedance (ohm)		DCR(ohm) Max.	Rated Current (mA) Max.
	±25% @100 MHz	±40% @1 GHz		
CME-CGMCB160808K-121	120	300 Typ.	0.30	300
CME-CGMCB160808K-221	220	500 Typ.	0.50	200
CME-CGMCB160808K-301	300	800 Typ.	0.60	200
CME-CGMCB160808K-331	330	800 Typ.	0.60	200
CME-CGMCB160808K-471	470	800 Typ.	0.70	200
CME-CGMCB160808K-601	600	1000 Typ.	0.80	200
CME-CGMCB160808K-801	800	1200 Typ.	0.90	100
CME-CGMCB160808K-102	1000	1400 Typ.	1.00	100

- Rated Current : the DC current value having temperature increased 40 °c after thru DC current 2 hours at ambient temperature.
- Storage Temperature Range : -40 °c ~ +85 °c
- Operating Temperature Range : -55 °c ~ +125 °c

Note 1 : Circuit design, component placement, PCB trace size and thickness, airflow and other cooling. Provision all affect the part Temperature. Part temperature should be verified in the end application.

▪ You can also contact us by e-mail : [coilmaster@coilmaster.com](mailto:coilmaster@coilmaster.com)

- All specifications are subject to change without notice.
- Update date : 2023.03.29

[www.coilmaster.com](http://www.coilmaster.com)

## Electrical characteristics

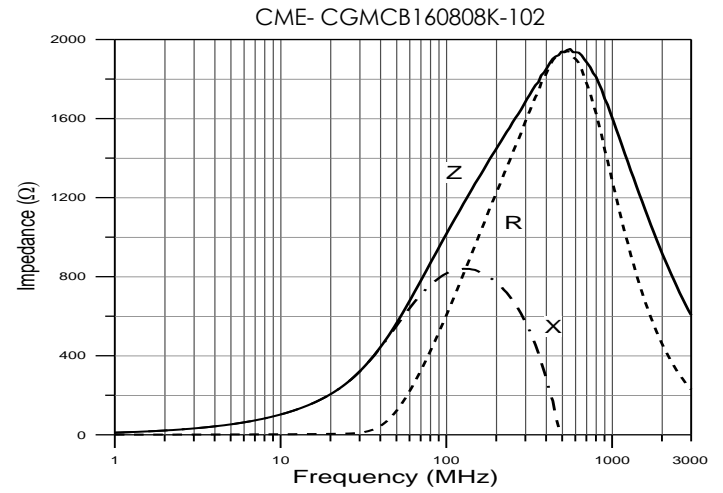
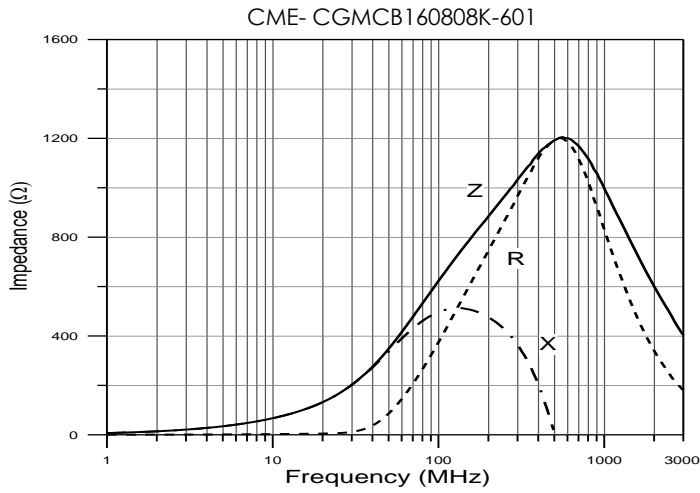

- You can also contact us by e-mail : [coilmaster@coilmaster.com](mailto:coilmaster@coilmaster.com)
- All specifications are subject to change without notice.
- Update date : 2023.03.29

## Packaging

(1) Package quantity : 4,000 (pcs/reel)

(2) Reel Dimensions (unit:mm)

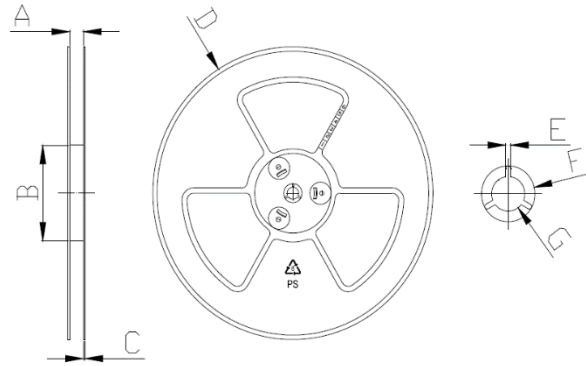

A	B	C	D	E	F	G
10.00	60.00	2.00	178.0	2.00	21.00	13.00
+1.50	+2.00	+0.50	+2.00	+0.50	+0.80	+0.80
-1.50	-2.00	-0.50	-2.00	-0.50	-0.80	-0.80

(3) Tape Dimensions

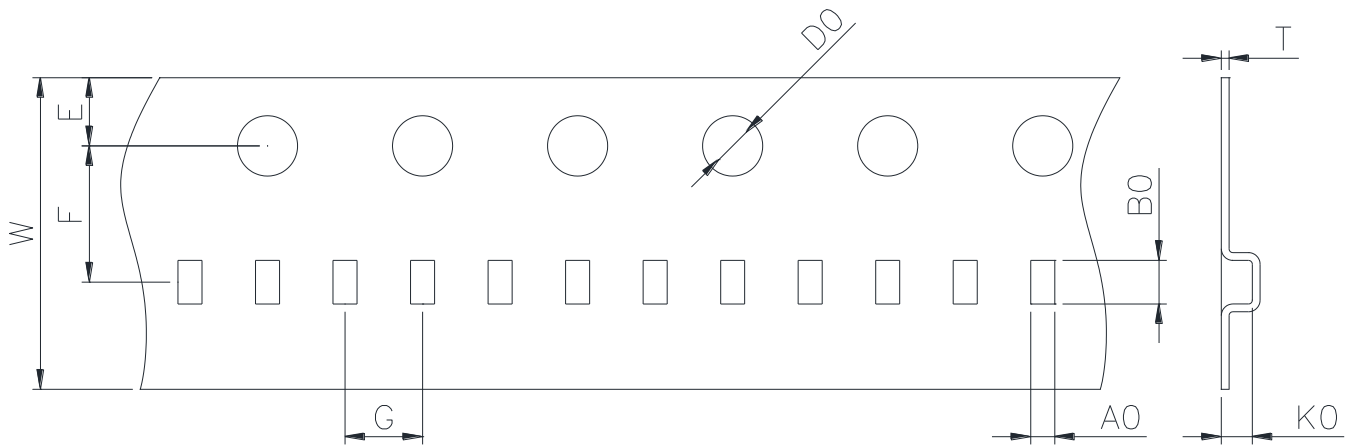

W	A0	B0	T	E	F	G	D0	K0
8.00	1.10	1.90	0.20	1.75	3.50	4.00	1.50	1.10
+0.20	+0.10	+0.10	+0.05	+0.10	+0.05	+0.10	+0.10	+0.05
-0.20	-0.10	-0.10	-0.05	-0.10	-0.05	-0.10	-0.00	-0.05

Korea Sales Office (KOREA) +82)31-904-1444

China Sales Office (CHINA) +86)0758-683-1444

Hungary Sales office (EUROPE) +36)1-404-5832

H.K Sales Office (HONGKONG) +852)2711-5551

LA Sales Office (USA) +1)714-616-6989

• You can also contact us by e-mail : [coilmaster@coilmaster.com](mailto:coilmaster@coilmaster.com)

• All specifications are subject to change without notice.

• Update date : 2023.03.29

[www.coilmaster.com](http://www.coilmaster.com)