

CME-CHMCB201209A-SERIES

Features

- ▶ Halogen-Free / RoHS compliant.
- ▶ Small size chips generate high impedance
- ▶ Monolithic structure for high reliability
- ▶ Excellent solderability and high heat resistance for either flow or reflow soldering
- ▶ The HMCB series can be used on high current circuits due to its low DC resistance.

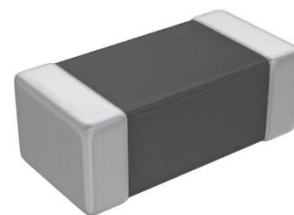

Applications

- ▶ Mother board, Tablet PC, Notebook, Desktop computers and peripheral equipment / DSC, DVC, LCD TV, Set top box / Digital communication equipment / Various automotive electronics / Various power line of electronic equipment

Dimension (Unit:mm)

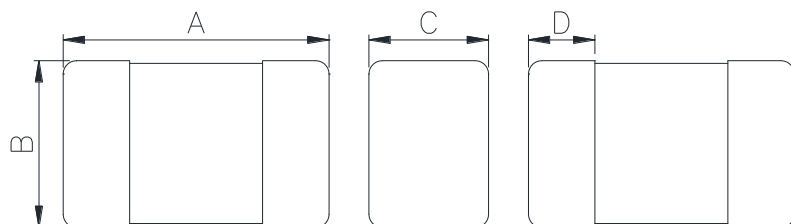

A	B	C	D
2.0±0.2	1.25±0.2	0.9 ^{+0.15} _{-0.2}	0.2~0.8

Land Pattern (Unit:mm)

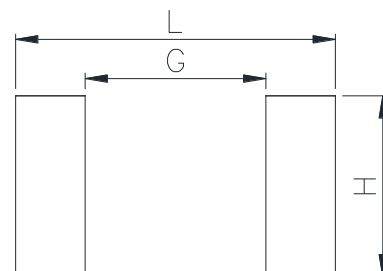

L	G	H
2.3	1.3	1.3

Regulation of part number

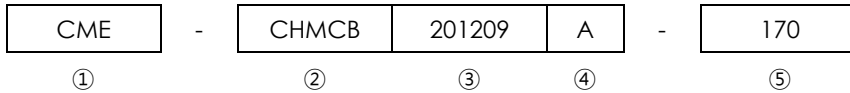

- ① CoilMaster's initial
- ② Product Series Name
- ③ Core Size (unit:mm)
- ④ Material Code
- ⑤ Normal Impedance (170 : 17 ohm)

Specifications

Part Number	Impedance (ohm) $\pm 25\%$	DCR(ohm) Max.	Rated Current (A)Max.
CME-CHMCB201209A-170	17	0.03	3.00
CME-CHMCB201209A-310	31	0.03	3.00
CME-CHMCB201209A-470	47	0.03	3.00
CME-CHMCB201209A-520	52	0.03	3.00
CME-CHMCB201209A-600	60	0.04	3.00
CME-CHMCB201209A-800	80	0.04	3.00
CME-CHMCB201209A-101	100	0.04	3.00
CME-CHMCB201209A-121	120	0.04	3.00
CME-CHMCB201209A-221	220	0.05	3.00
CME-CHMCB201209A-301	300	0.05	3.00
CME-CHMCB201209A-601	600	0.10	2.00
CME-CHMCB201209A-102	1000	0.30	1.00
CME-CHMCB201209A-152	1500	0.30	1.00

- Test Condition : 100 MHz, 500 mV
- Rated Current : the DC current value having temperature increased 40 °c after thru DC current 2 hours at ambient temperature.
- Storage Temperature Range : -40°c ~ +85 °c
- Operating Temperature Range : -55°c ~ +125 °c

Note 1 : Circuit design, component placement, PCB trace size and thickness, airflow and other cooling. Provision all affect the part Temperature. Part temperature should be verified in the end application.

▪ **You can also contact us by e-mail : coilmaster@coilmaster.com**

- All specifications are subject to change without notice.
- Update date : 2023.03.29

www.coilmaster.com

Electrical characteristics

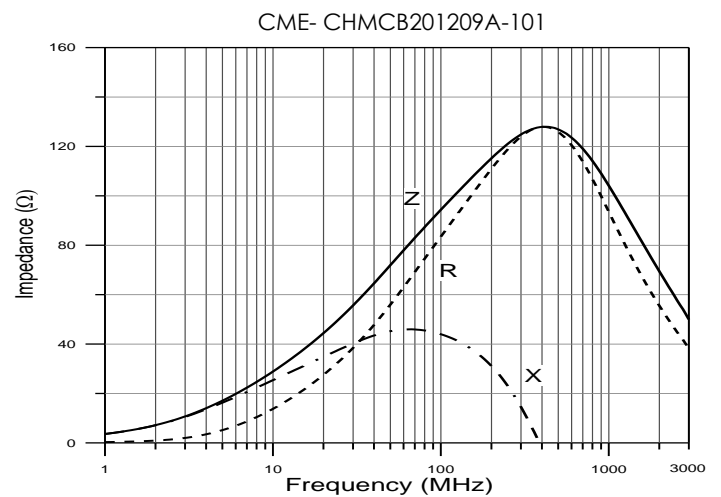
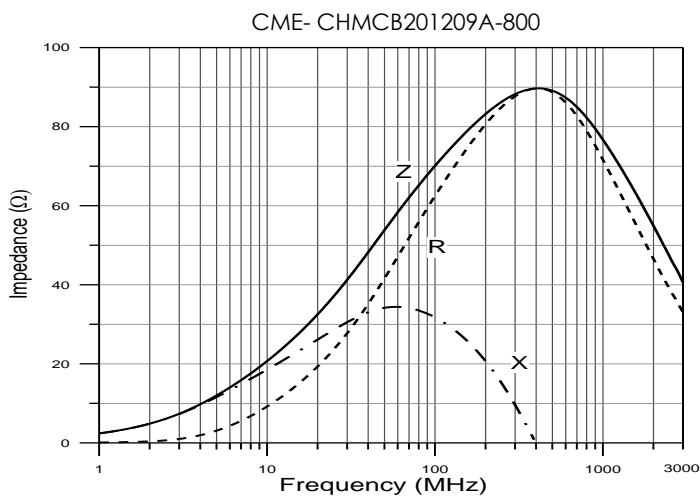
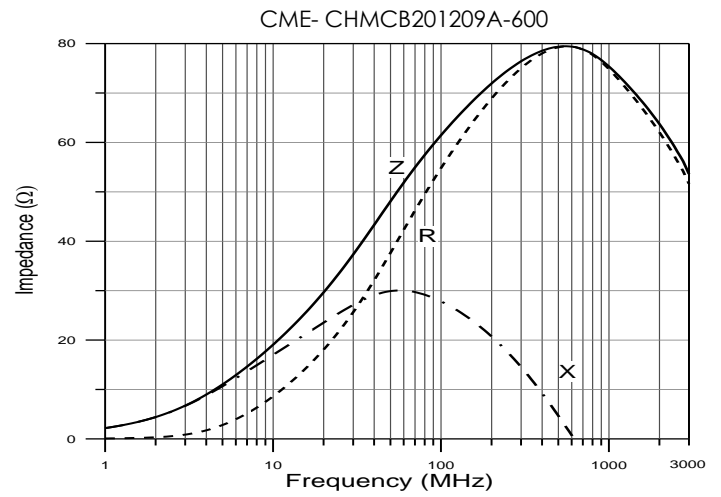
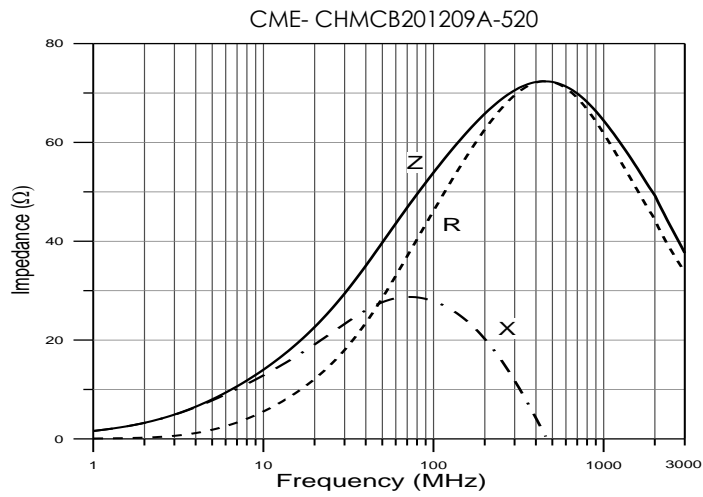
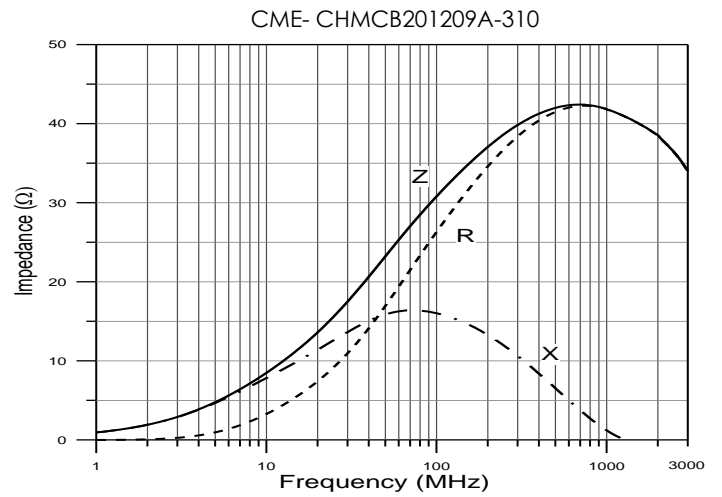
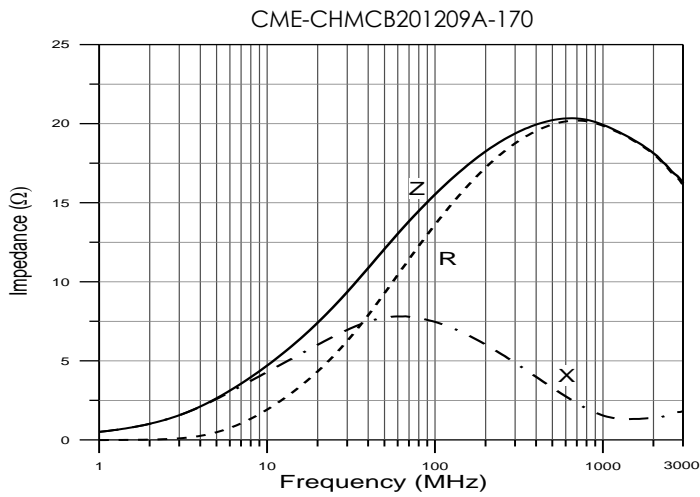

- You can also contact us by e-mail : coilmaster@coilmaster.com
- All specifications are subject to change without notice.
- Update date : 2023.03.29

CME- CHMCB201209A-121

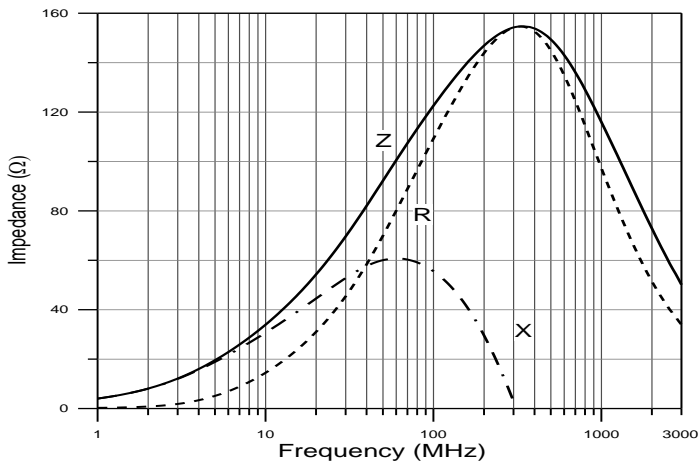

CME- CHMCB201209A-221

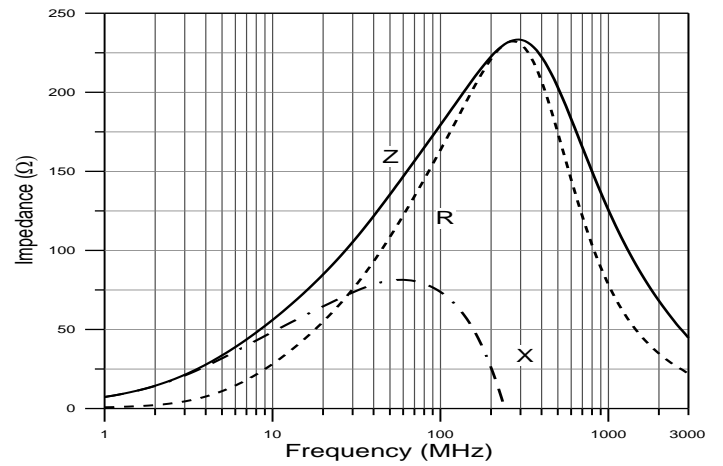

CME- CHMCB201209A-301

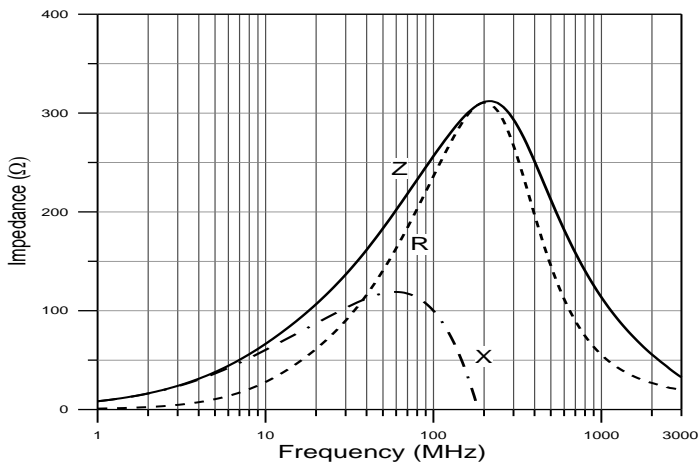

CME- CHMCB201209A-601

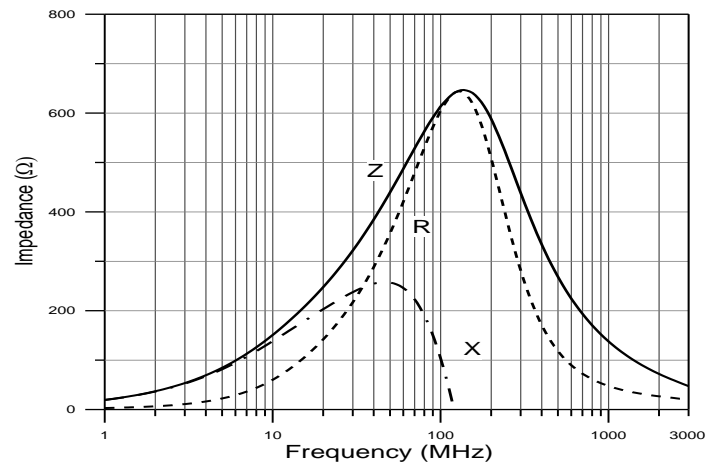

CME- CHMCB201209A-102

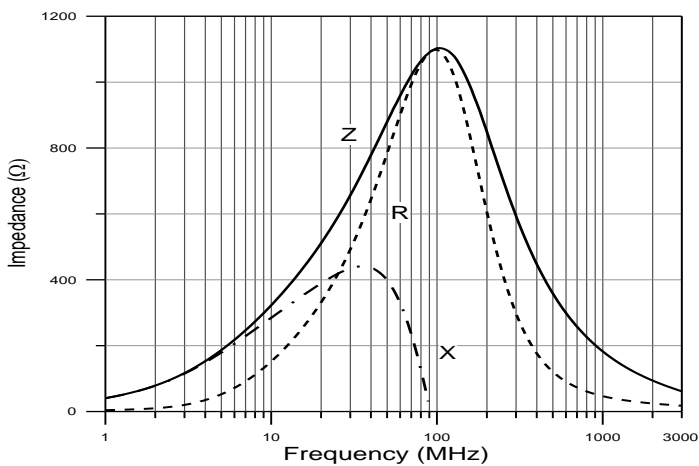

CME- CHMCB201209A-152

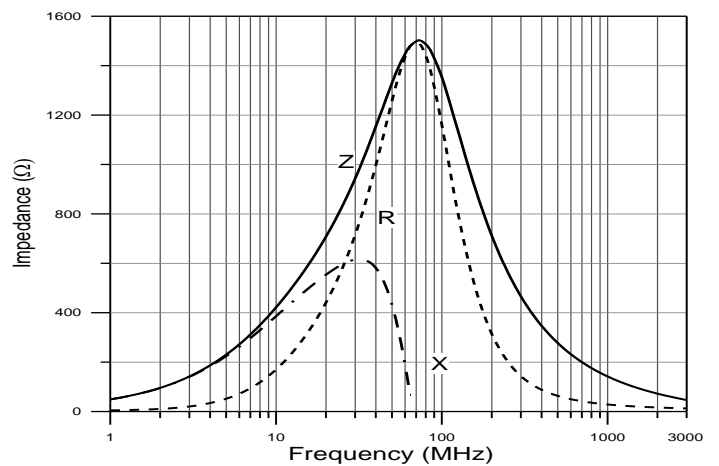

- You can also contact us by e-mail : coilmaster@coilmaster.com
- All specifications are subject to change without notice.
- Update date : 2023.03.29

Packaging

(1) Package quantity : 4,000 (pcs/reel)

(2) Reel Dimensions (unit:mm)

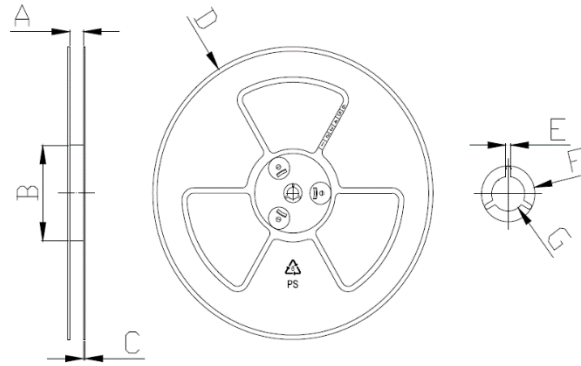

A	B	C	D	E	F	G
10.00	60.00	2.00	178.0	2.00	21.00	13.00
+1.50	+2.00	+0.50	+2.00	+0.50	+0.80	+0.80
-1.50	-2.00	-0.50	-2.00	-0.50	-0.80	-0.80

(3) Tape Dimensions

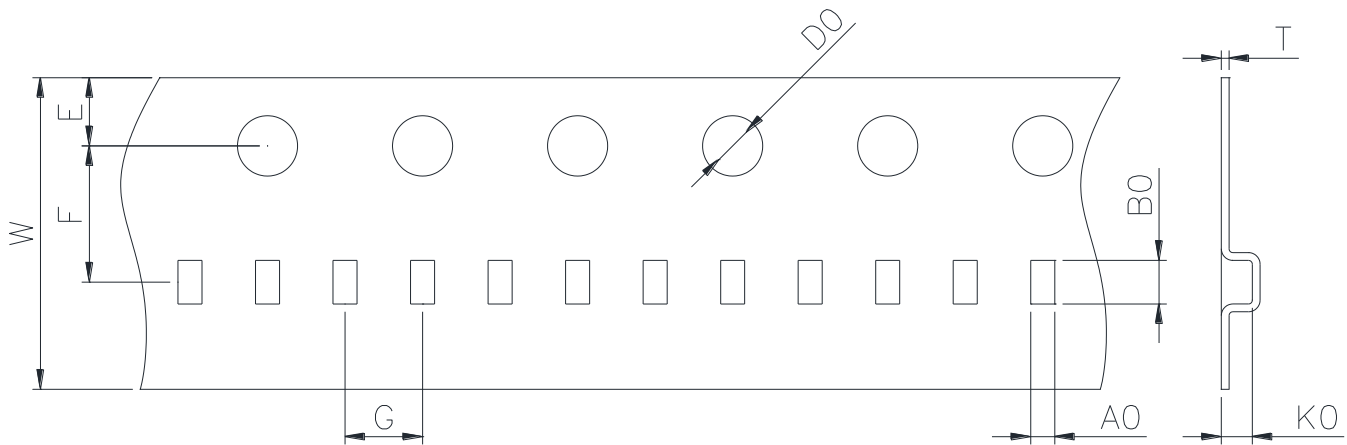

W	A0	B0	T	E	F	G	D0	K0
8.00	1.55	2.30	0.20	1.75	3.50	4.00	1.50	1.20
+0.20	+0.10	+0.10	+0.05	+0.10	+0.05	+0.10	+0.10	+0.05
-0.20	-0.10	-0.10	-0.05	-0.10	-0.05	-0.10	-0.00	-0.05

Korea Sales Office (KOREA) +82)31-904-1444
 China Sales Office (CHINA) +86)0758-683-1444
 Hungary Sales office (EUROPE) +36)1-404-5832

H.K Sales Office (HONGKONG) +852)2711-5551
 LA Sales Office (USA) +1)714-616-6989

• You can also contact us by e-mail : coilmaster@coilmaster.com

- All specifications are subject to change without notice.
- Update date : 2023.03.29

www.coilmaster.com