

CME-HMCB321611A-SERIES

Features

- ▶ Halogen-Free / RoHS compliant.
- ▶ Small size chips generate high impedance
- ▶ Monolithic structure for high reliability
- ▶ Excellent solderability and high heat resistance for either flow or reflow soldering
- ▶ The HMCB series can be used on high current circuits due to its low DC resistance.



Applications

- ▶ Mother board, Tablet PC, Notebook, Desktop computers and peripheral equipment / DSC, DVC, LCD TV, Set top box / Digital communication equipment / Various automotive electronics / Various power line of electronic equipment

Dimension (Unit:mm)

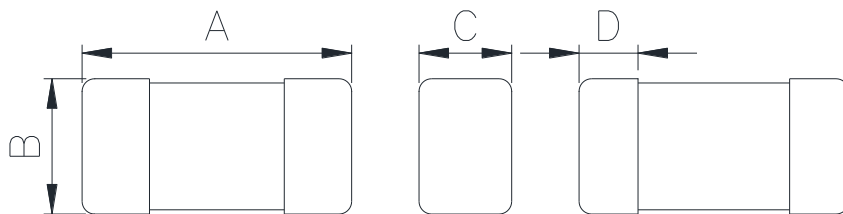

A	B	C	D
3.2±0.2	1.6±0.2	1.1±0.2	0.4~1.0

Land Pattern (Unit:mm)

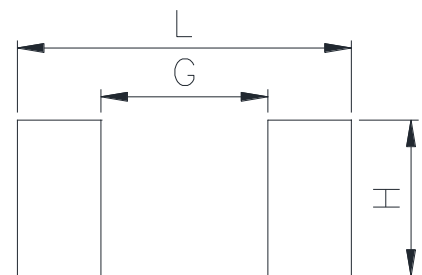

L	G	H
4.40	2.20	2.06

Regulation of part number

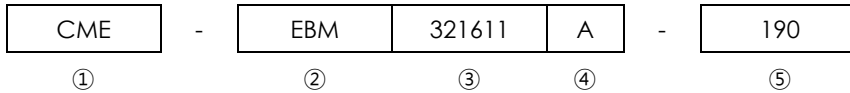

- ① CoilMaster's initial
- ② Product Series Name
- ③ Core Size (unit:mm)
- ④ Material Code
- ⑤ Normal Impedance (190 : 19 ohm)

Specifications

Part Number	Impedance (ohm) ±25%	DCR(ohm) Max.	Rated Current (A)Max.
CME-HMCB321611A-190	19	0.03	3.00
CME-HMCB321611A-310	31	0.03	3.00
CME-HMCB321611A-520	52	0.03	3.00
CME-HMCB321611A-700	70	0.04	3.00
CME-HMCB321611A-101	100	0.04	3.00
CME-HMCB321611A-151	150	0.05	3.00
CME-HMCB321611A-301	300	0.06	3.00
CME-HMCB321611A-501	500	0.07	2.50
CME-HMCB321611A-601	600	0.08	2.00
CME-HMCB321611A-102	1000	0.30	1.00

- Test Condition : 100 MHz, 500 mV
- Rated Current : the DC current value having temperature increased 40 °c after thru DC current 2 hours at ambient temperature.
- Storage Temperature Range : -40 °c ~ +85 °c
- Operating Temperature Range : -55 °c ~ +125 °c

Note 1 : Circuit design, component placement, PCB trace size and thickness, airflow and other cooling. Provision all affect the part Temperature. Part temperature should be verified in the end application.

▪ **You can also contact us by e-mail : coilmaster@coilmaster.com**

- All specifications are subject to change without notice.
- Update date : 2023.03.29

www.coilmaster.com

Electrical characteristics

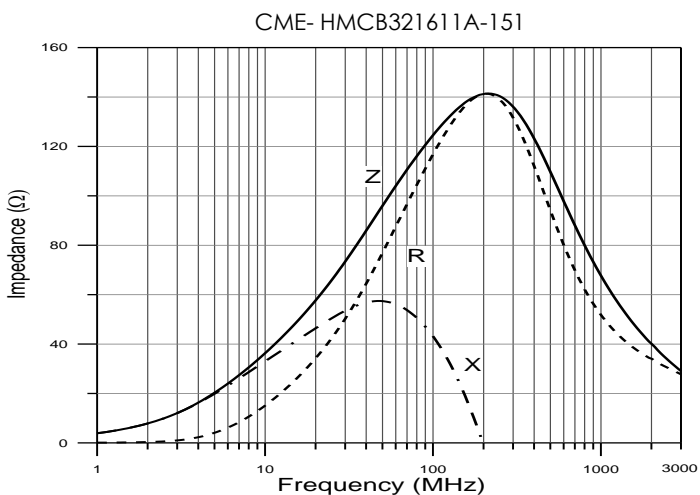
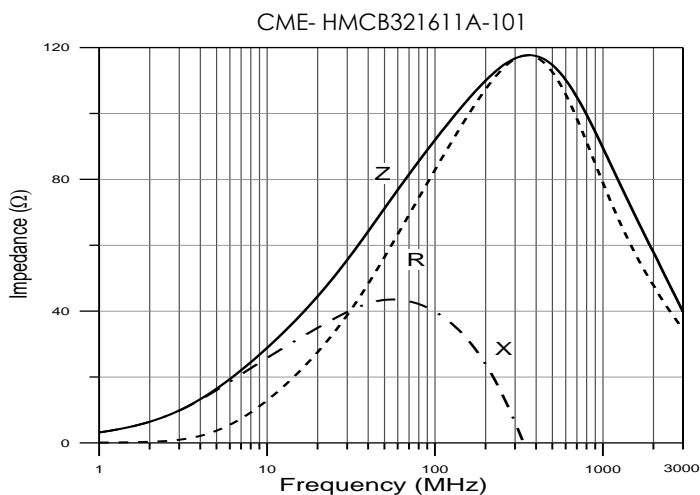
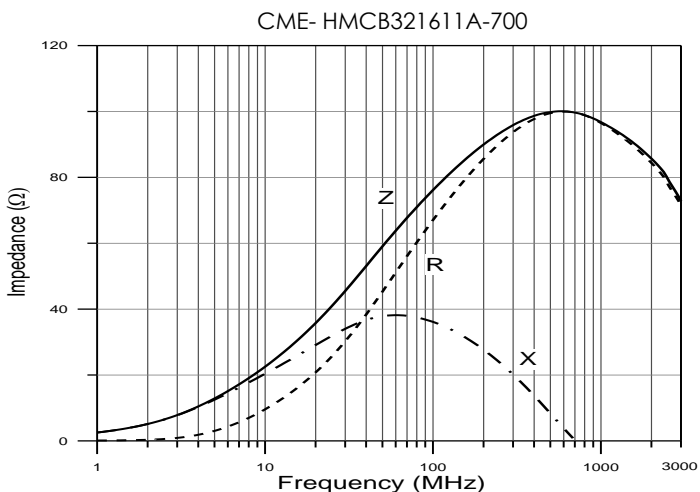
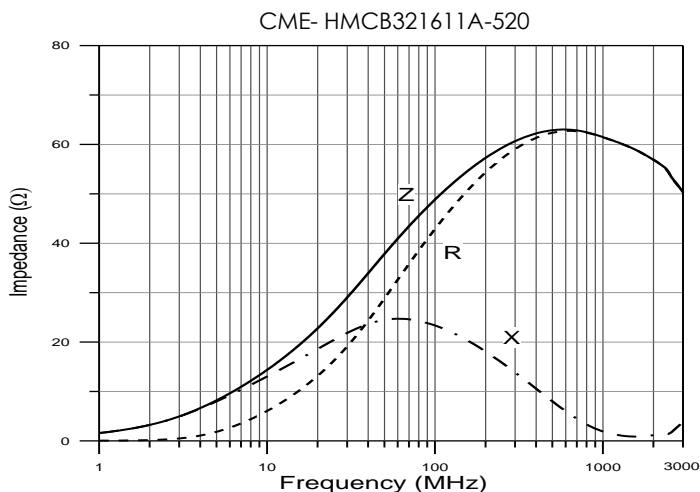
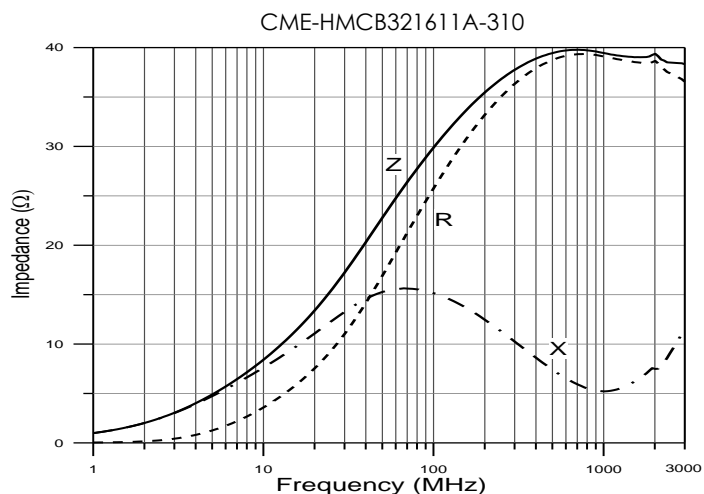
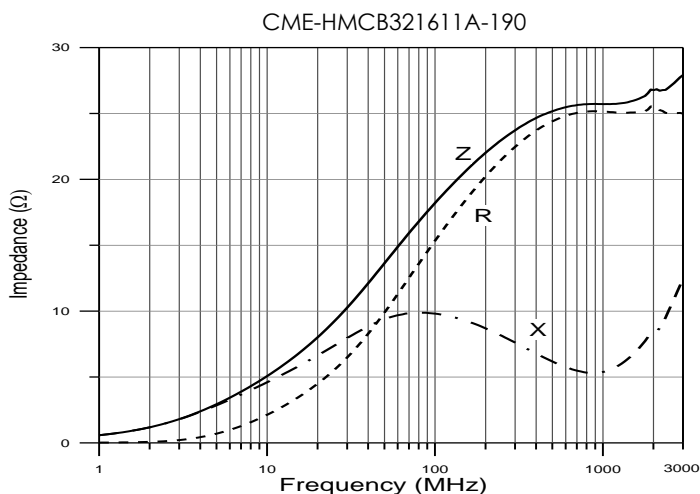

- You can also contact us by e-mail : coilmaster@coilmaster.com
- All specifications are subject to change without notice.
- Update date : 2023.03.29

CME- HMCB321611A-301

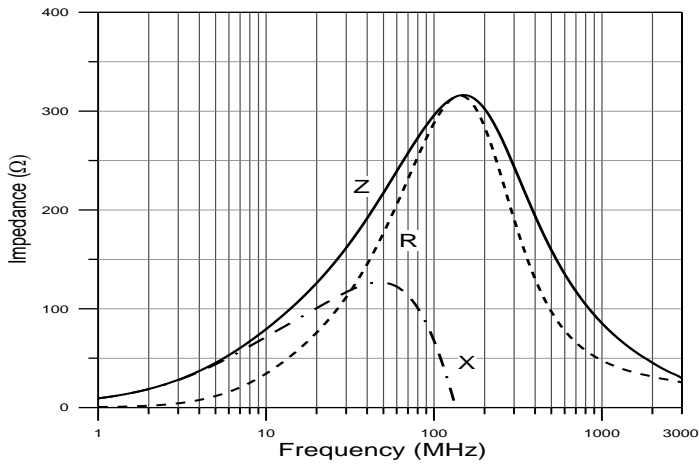

CME- HMCB321611A-501

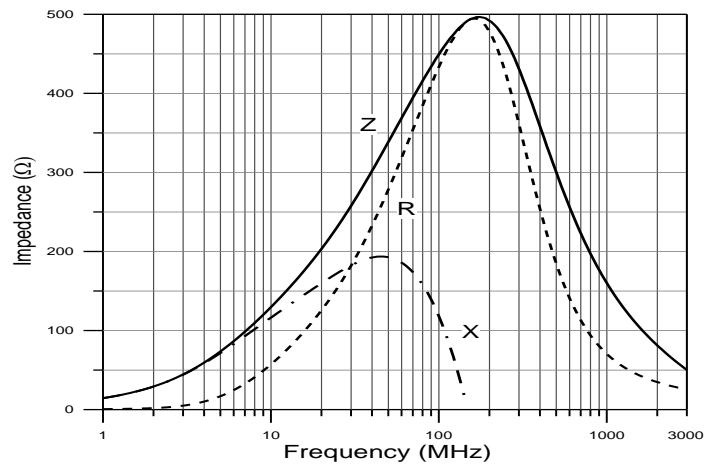

CME- HMCB321611A-601

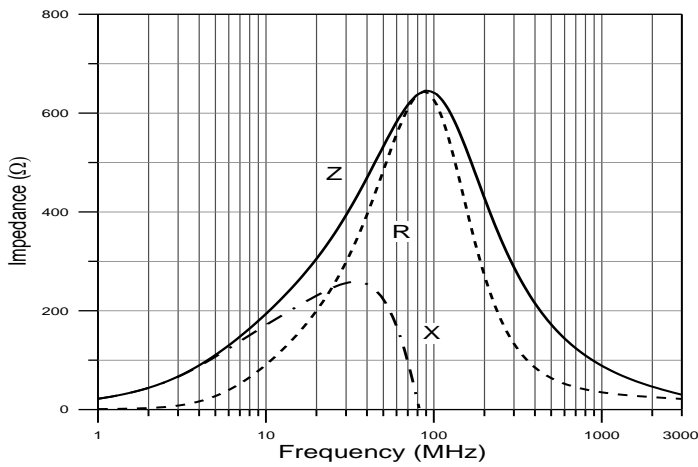

CME- HMCB321611A-102

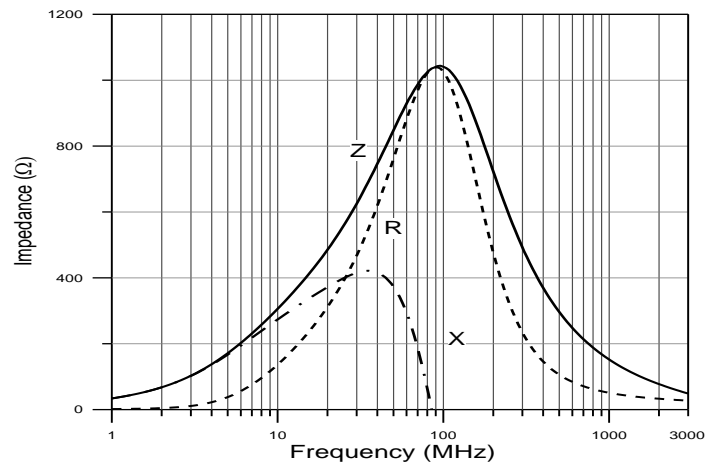

- You can also contact us by e-mail : coilmaster@coilmaster.com
- All specifications are subject to change without notice.
- Update date : 2023.03.29

Packaging

(1) Package quantity : 3,000 (pcs/reel)

(2) Reel Dimensions (unit:mm)

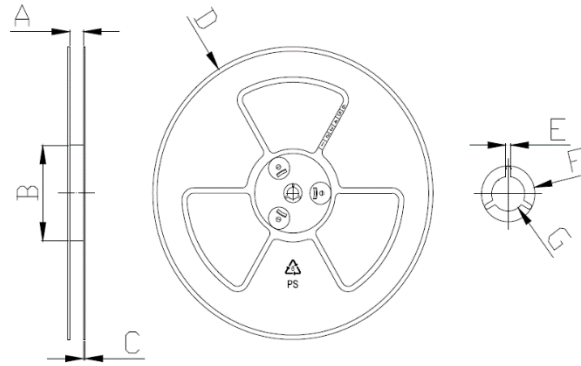

A	B	C	D	E	F	G
10.00	60.00	2.00	178.0	2.00	21.00	13.00
+1.50	+2.00	+0.50	+2.00	+0.50	+0.80	+0.80
-1.50	-2.00	-0.50	-2.00	-0.50	-0.80	-0.80

(3) Tape Dimensions

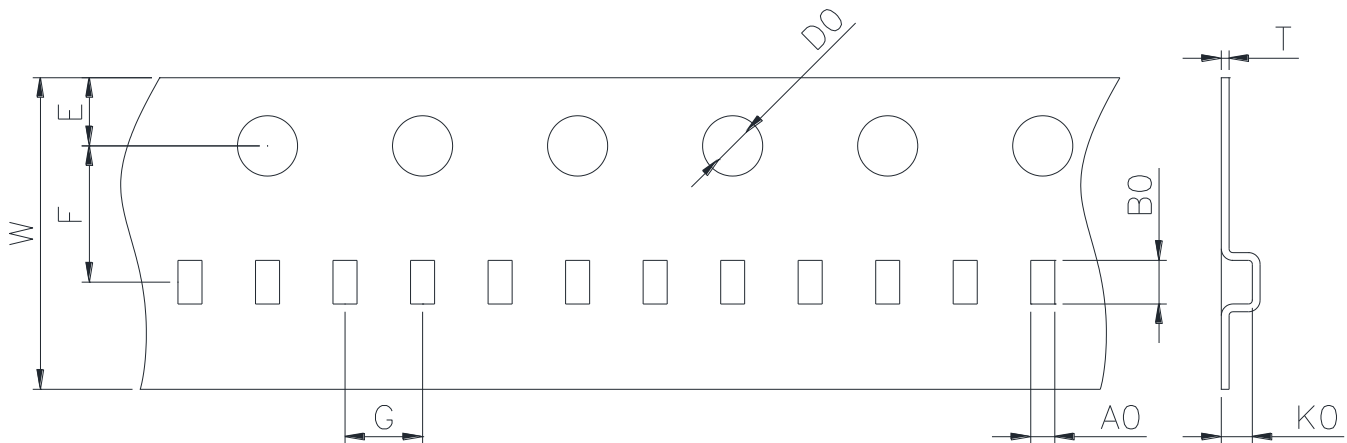

W	A0	B0	T	E	F	G	D0	K0
8.00	1.90	3.50	0.20	1.75	3.50	4.00	1.50	1.40
+0.20	+0.10	+0.10	+0.05	+0.10	+0.05	+0.10	+0.10	+0.05
-0.20	-0.10	-0.10	-0.05	-0.10	-0.05	-0.10	-0.00	-0.05

Korea Sales Office (KOREA) +82)31-904-1444
 China Sales Office (CHINA) +86)0758-683-1444
 Hungary Sales office (EUROPE) +36)1-404-5832

H.K Sales Office (HONGKONG) +852)2711-5551
 LA Sales Office (USA) +1)714-616-6989

• You can also contact us by e-mail : coilmaster@coilmaster.com

- All specifications are subject to change without notice.
- Update date : 2023.03.29

www.coilmaster.com