

# CME-HMCB451616A-SERIES

## Features

- ▶ Halogen-Free / RoHS compliant.
- ▶ Small size chips generate high impedance
- ▶ Monolithic structure for high reliability
- ▶ Excellent solderability and high heat resistance for either flow or reflow soldering
- ▶ The HMCB series can be used on high current circuits due to its low DC resistance.



## Applications

- ▶ Mother board, Tablet PC, Notebook, Desktop computers and peripheral equipment / DSC, DVC, LCD TV, Set top box / Digital communication equipment / Various automotive electronics / Various power line of electronic equipment

**Dimension (Unit:mm(inch))**

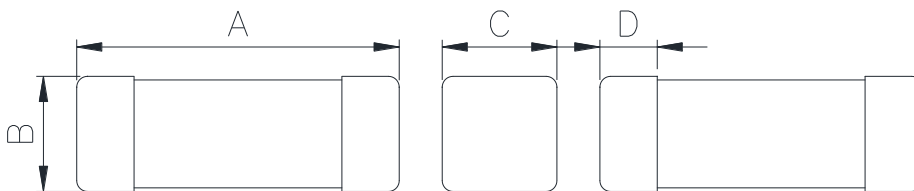

A	B	C	D
4.5±0.2	1.6±0.2	1.6±0.2	0.6~1.0

**Land Pattern (Unit:mm)**

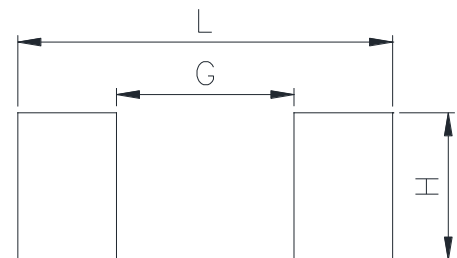

L	G	H
5.70	2.70	2.24



## Electrical characteristics

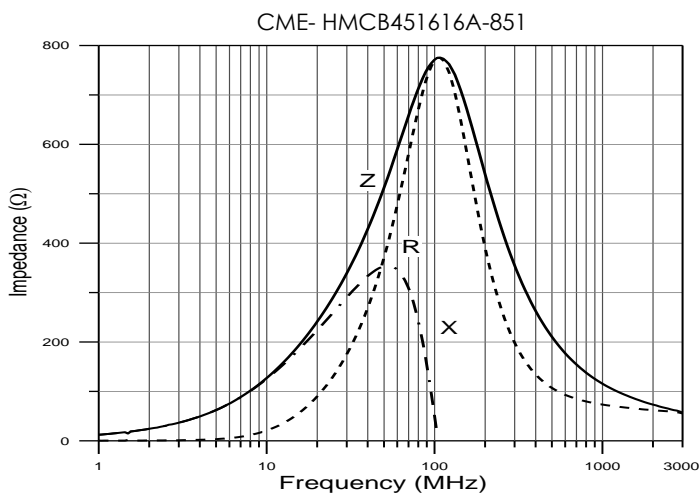
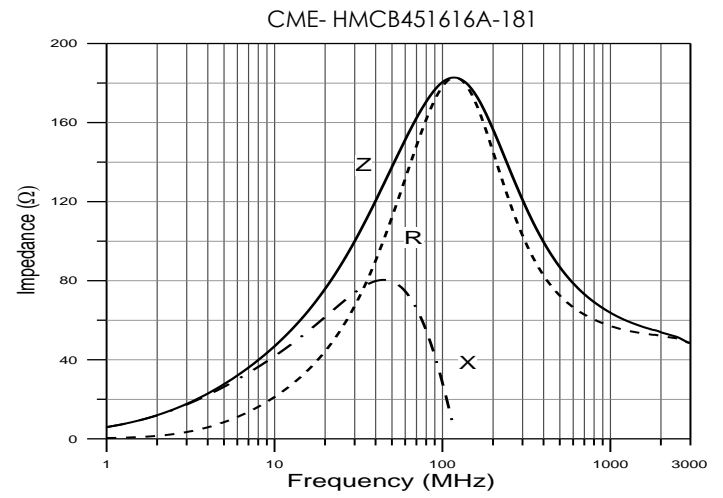
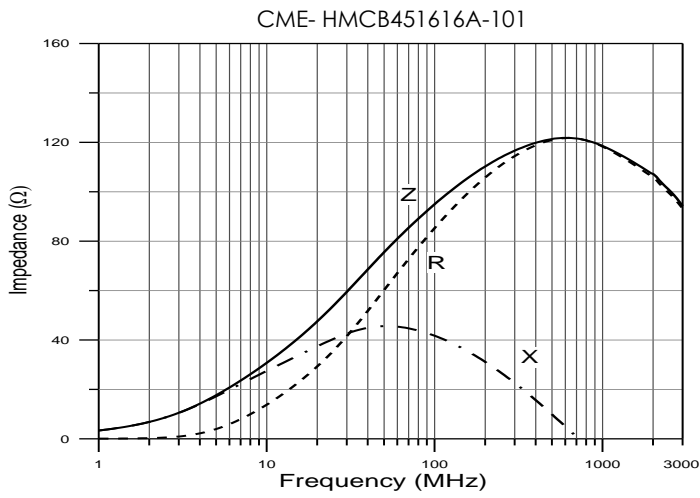
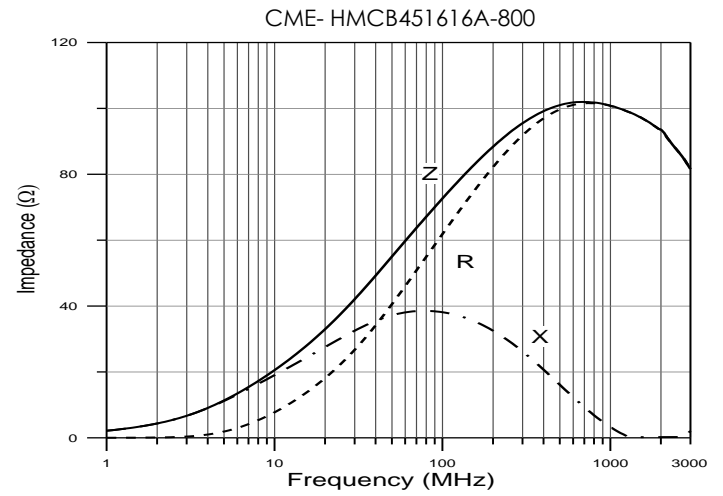
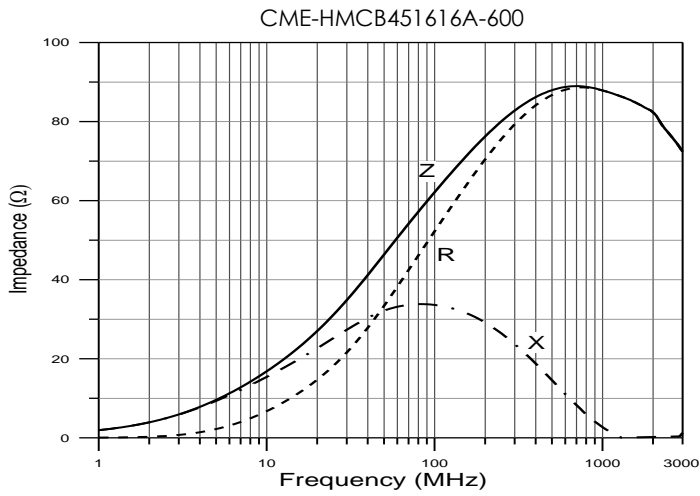

- You can also contact us by e-mail : [coilmaster@coilmaster.com](mailto:coilmaster@coilmaster.com)
- All specifications are subject to change without notice.
- Update date : 2023.03.29

## Packaging

(1) Package quantity : 2,000 (pcs/reel)

(2) Reel Dimensions (unit:mm)

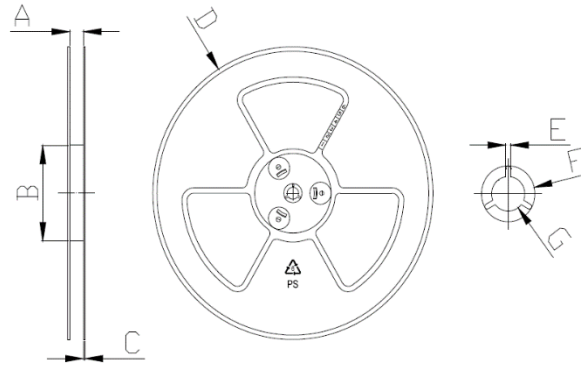

A	B	C	D	E	F	G
10.00	60.00	2.00	178.0	2.00	21.00	13.00
+1.50	+2.00	+0.50	+2.00	+0.50	+0.80	+0.80
-1.50	-2.00	-0.50	-2.00	-0.50	-0.80	-0.80

(3) Tape Dimensions

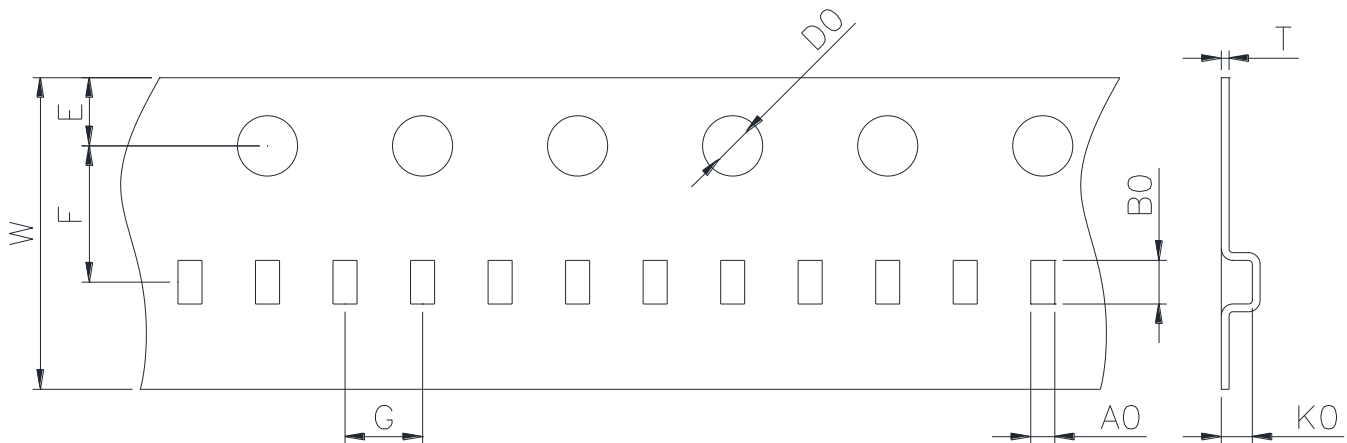

W	A0	B0	T	E	F	G	D0	K0
8.00	2.90	4.90	0.30	1.75	3.50	4.00	1.50	1.40
+0.20	+0.10	+0.10	+0.05	+0.10	+0.05	+0.10	+0.10	+0.05
-0.20	-0.10	-0.10	-0.05	-0.10	-0.05	-0.10	-0.00	-0.05

Korea Sales Office (KOREA) +82)31-904-1444  
 China Sales Office (CHINA) +86)0758-683-1444  
 Hungary Sales office (EUROPE) +36)1-404-5832

H.K Sales Office (HONGKONG) +852)2711-5551  
 LA Sales Office (USA) +1)714-616-6989

• You can also contact us by e-mail : [coilmaster@coilmaster.com](mailto:coilmaster@coilmaster.com)

- All specifications are subject to change without notice.
- Update date : 2023.03.29

[www.coilmaster.com](http://www.coilmaster.com)