

CME-NMCB453215A-SERIES

Features

- ▶ Halogen-Free / RoHS compliant.
- ▶ Small size chips generate high impedance
- ▶ Monolithic structure for high reliability
- ▶ Excellent solderability and high heat resistance for either flow or reflow soldering
- ▶ Low DC resistance structure of electrode prevents wasteful electric power consumption

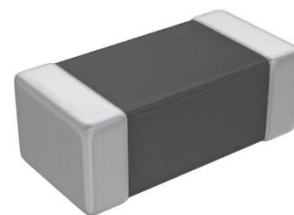

Applications

- ▶ Mother board, Tablet PC, Notebook, Desktop computers and peripheral equipment / DSC, DVC, LCD TV, Set top box / Mobile phone, Smart phone, PND / Digital communication equipment / Various automotive electronics / Circuit where a stable ground is unavailable

Dimension (Unit:mm)

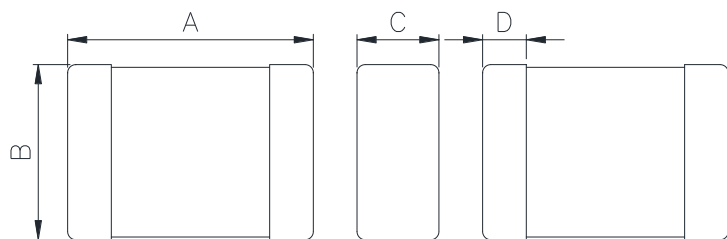

| A | B | C | D |
|---------|---------|---------|---------|
| 4.5±0.2 | 3.2±0.2 | 1.5±0.2 | 0.6~1.0 |

Land Pattern (Unit:mm)

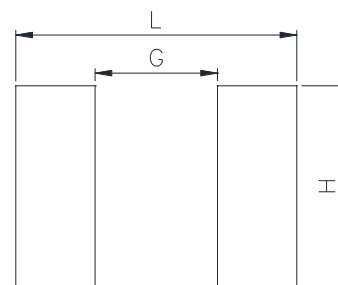

| L | G | H |
|------|------|------|
| 5.90 | 2.57 | 4.22 |

Regulation of part number

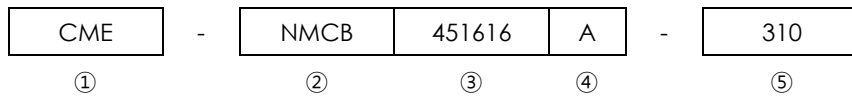

- ① CoilMaster's initial
- ② Product Series Name
- ③ Core Size (unit:mm)
- ④ Material Code
- ⑤ Normal Impedance (310 : 31 ohm)

Specifications

| Part Number | Impedance (ohm) $\pm 25\%$ | DCR(ohm) Max. | Rated Current (mA)Max. |
|---------------------|-------------------------------|------------------|------------------------------|
| CME-NMCB453215A-310 | 31 | 0.10 | 500 |
| CME-NMCB453215A-600 | 60 | 0.20 | 500 |
| CME-NMCB453215A-121 | 120 | 0.20 | 500 |
| CME-NMCB453215A-151 | 150 | 0.20 | 500 |
| | | | |
| | | | |
| | | | |
| | | | |
| | | | |
| | | | |
| | | | |
| | | | |
| | | | |
| | | | |
| | | | |
| | | | |
| | | | |

- Test Condition : 100 MHz, 500 mV
- Rated Current : the DC current value having temperature increased 40 °c after thru DC current 2 hours at ambient temperature.
- Storage Temperature Range : -40 °c ~ +85 °c
- Operating Temperature Range : -55 °c ~ +125 °c

Note 1 : Circuit design, component placement, PCB trace size and thickness, airflow and other cooling. Provision all affect the part Temperature. Part temperature should be verified in the end application.

▪ **You can also contact us by e-mail : coilmaster@coilmaster.com**

- All specifications are subject to change without notice.
- Update date : 2023.03.29

www.coilmaster.com

Electrical characteristics

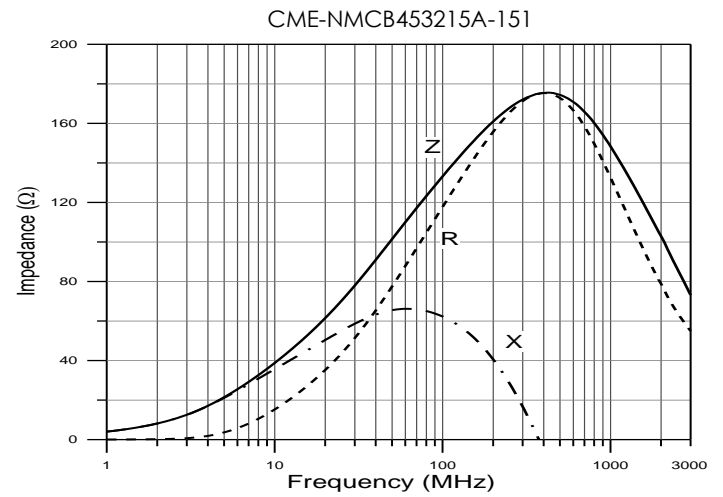
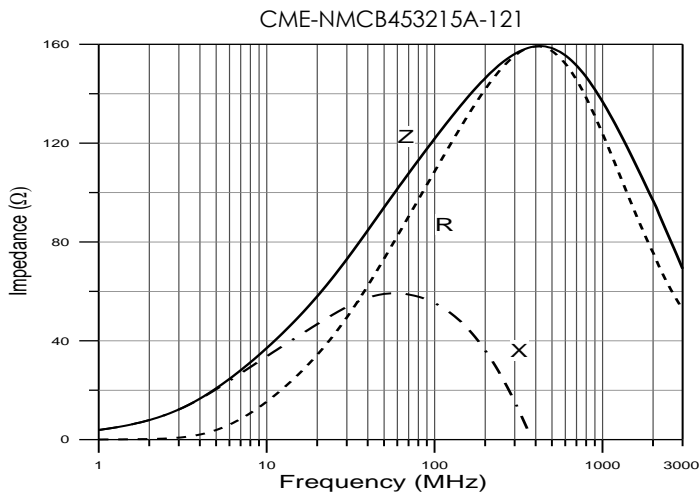

- You can also contact us by e-mail : coilmaster@coilmaster.com
- All specifications are subject to change without notice.
- Update date : 2023.03.29

Packaging

(1) Package quantity : 1,000 (pcs/reel)

(2) Reel Dimensions (unit:mm)

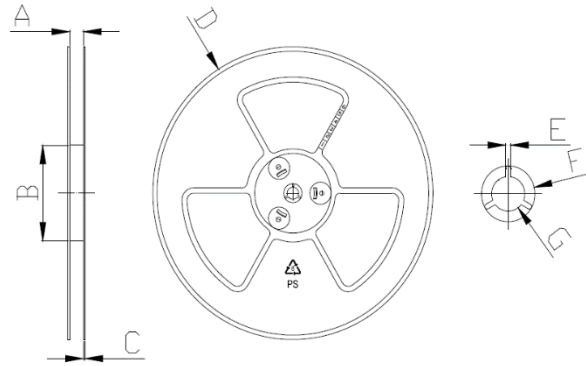

| A | B | C | D | E | F | G |
|-------|-------|-------|-------|-------|-------|-------|
| 10.00 | 60.00 | 2.00 | 178.0 | 2.00 | 21.00 | 13.00 |
| +1.50 | +2.00 | +0.50 | +2.00 | +0.50 | +0.80 | +0.80 |
| -1.50 | -2.00 | -0.50 | -2.00 | -0.50 | -0.80 | -0.80 |

(3) Tape Dimensions

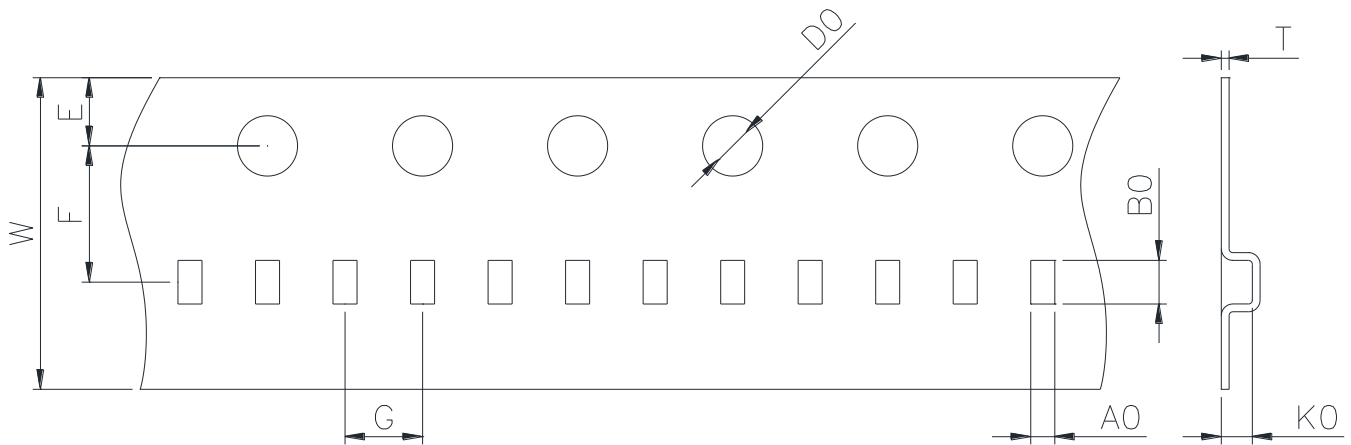

| W | A0 | B0 | T | E | F | G | D0 | K0 |
|-------|-------|-------|-------|-------|-------|-------|-------|-------|
| 8.00 | 3.60 | 4.90 | 0.30 | 1.75 | 3.50 | 4.00 | 1.50 | 2.05 |
| +0.20 | +0.10 | +0.10 | +0.05 | +0.10 | +0.05 | +0.10 | +0.10 | +0.05 |
| -0.20 | -0.10 | -0.10 | -0.05 | -0.10 | -0.05 | -0.10 | -0.00 | -0.05 |

Korea Sales Office (KOREA) +82)31-904-1444
 China Sales Office (CHINA) +86)0758-683-1444
 Hungary Sales office (EUROPE) +36)1-404-5832

H.K Sales Office (HONGKONG) +852)2711-5551
 LA Sales Office (USA) +1)714-616-6989

• You can also contact us by e-mail : coilmaster@coilmaster.com

- All specifications are subject to change without notice.
- Update date : 2023.03.29

www.coilmaster.com