

CMI-CMMP4020HL-A SERIES

Features

- ▶ High current and low profile
- ▶ Compact design.
- ▶ Metal powder molding type for EMC protection.
- ▶ Available tape and reel for auto insertion.
- ▶ Halogen-Free.
- ▶ RoHS compliant.
- ▶ AEC-Q200 qualified.

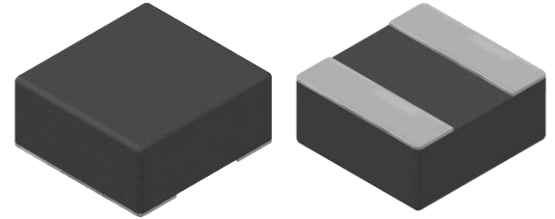

Applications

- ▶ Car navigation, Car stereo and Car accessories, ADAS ECU,

Dimension (Unit:mm)

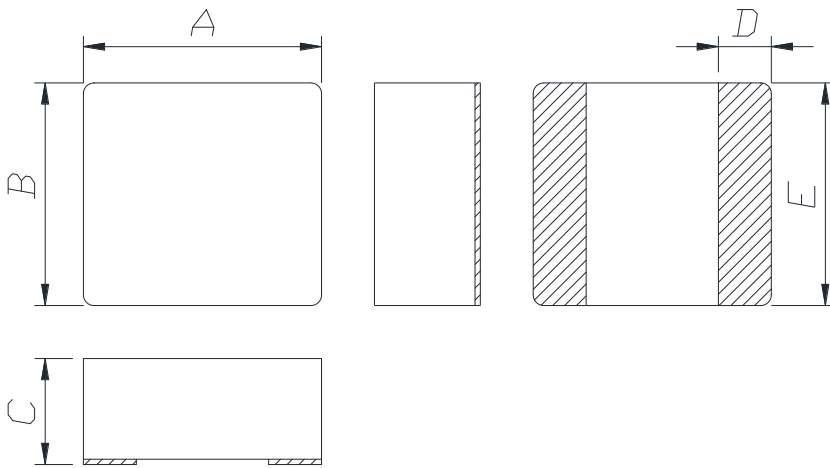

A	B	C	D	E
4.5 ±0.3	4.2 ±0.3	2.0 Max.	1.0 ±0.3	4.2 ±0.3

Land Pattern (Unit:mm)

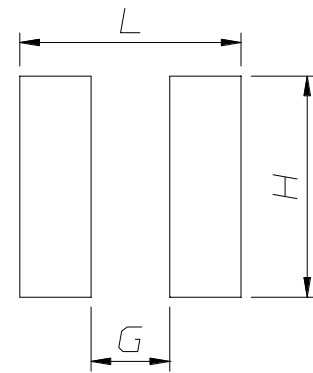

L	G	H
4.5	1.6	4.3

Regulation of part number

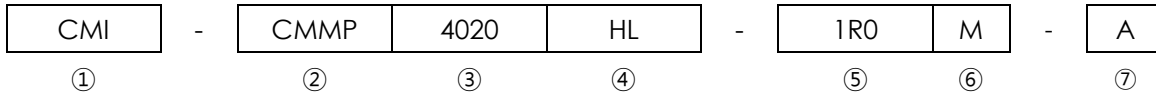

- ① CoilMaster's initial
- ② Series Name : Car Metal Molded Power inductor
- ③ Core Size (unit:mm)
- ④ Type
- ⑤ Typical inductance value (1.0uH)
- ⑥ Inductance tolerance ($\pm 20\%$)
- ⑦ Revision (A)

Specifications

Part Number	Inductance (uH) $\pm 20\%$	DCR(mohm) Max.(Typ.)	Isat(A) Max.(Typ.)	Itemp(A) Max.(Typ.)	Test Frequency (Hz)
CMI-CMMP4020HL-1R0M-A	1.0	39(32.5)	10.0(11.0)	5.0(5.5)	1M
CMI-CMMP4020HL-1R5M-A	1.5	42(35)	7.5(8.5)	4.7(5.2)	1M
CMI-CMMP4020HL-2R2M-A	2.2	54(45)	7.0(8.0)	4.0(4.5)	1M
CMI-CMMP4020HL-3R3M-A	3.3	78(65)	6.0(7.0)	3.2(3.7)	1M
CMI-CMMP4020HL-4R7M-A	4.7	102(85)	5.5(6.5)	2.8(3.3)	1M
CMI-CMMP4020HL-6R8M-A	6.8	156(130)	4.5(5.0)	2.4(2.6)	1M
CMI-CMMP4020HL-8R2M-A	8.2	174(145)	3.5(4.0)	2.2(2.5)	1M
CMI-CMMP4020HL-100M-A	10	228(190)	3.3(3.8)	1.7(1.9)	1M

- Isat: When based on the inductance change rate (Approximately 30% below in the initial value)
- Itemp: When based on the temperature increase (Temperature increase of approximately 40°C by self heating)
- Operating Temperature Range (including self temperature) : -40°C ~ +150 °c

Note 1 : Circuit design, component placement, PCB trace size and thickness, airflow and other cooling. Provision all affect the part Temperature. Part temperature should be verified in the end application.

- **You can also contact us by e-mail : coilmaster@coilmaster.com**
- All specifications are subject to change without notice.
- Update date : 2023.05.25

Electrical characteristics

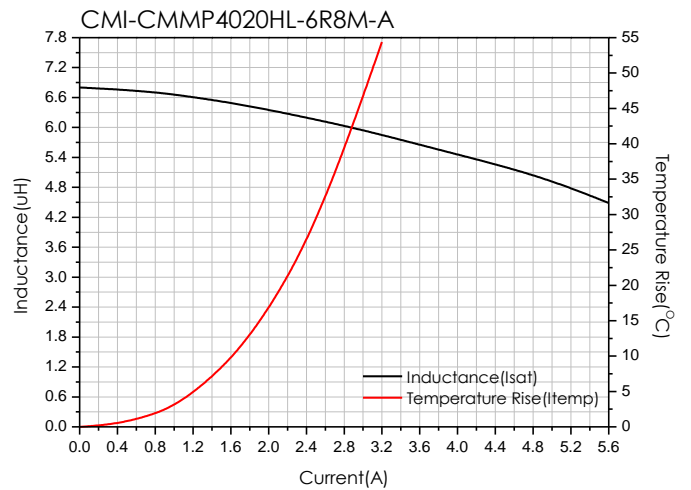
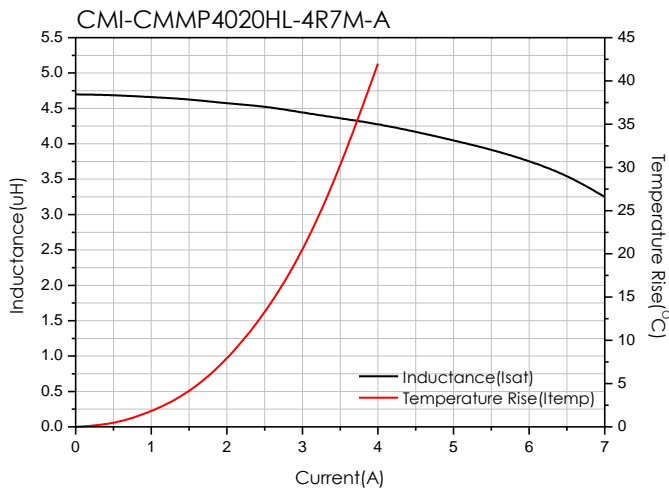
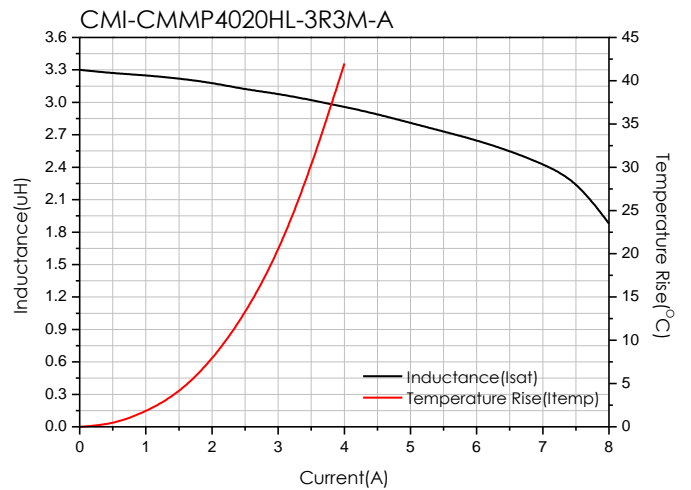
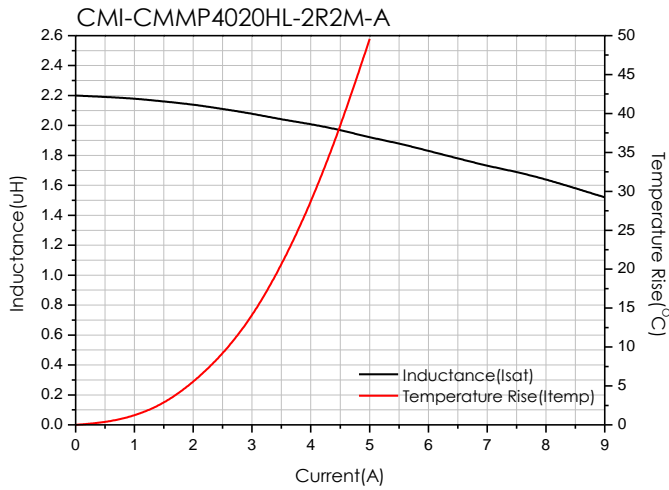
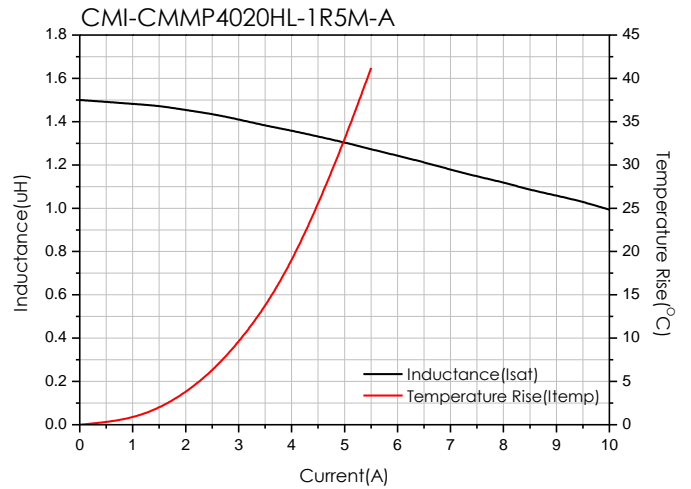
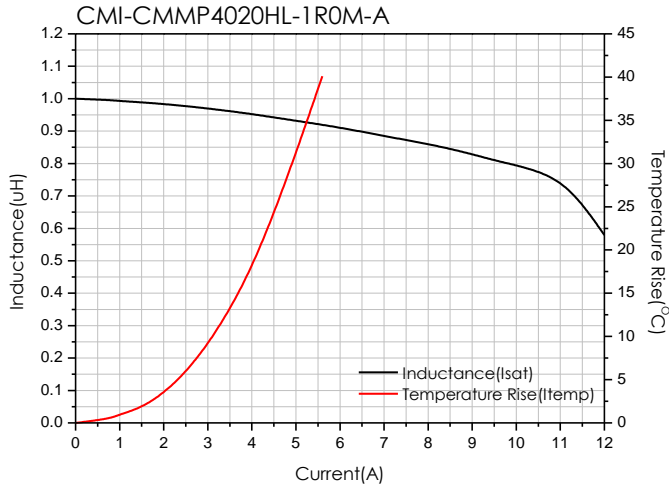

- You can also contact us by e-mail : coilmaster@coilmaster.com
- All specifications are subject to change without notice.
- Update date : 2023.05.25

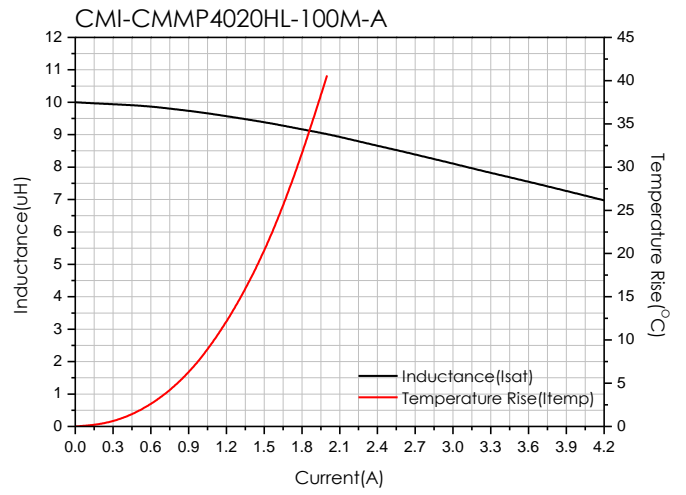
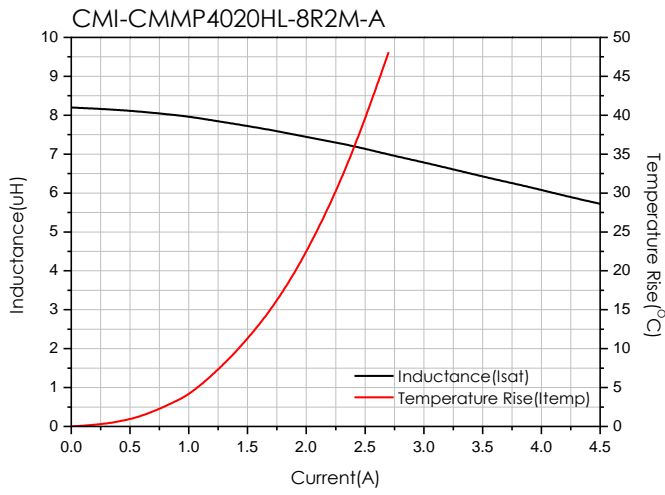

- You can also contact us by e-mail : coilmaster@coilmaster.com
- All specifications are subject to change without notice.
- Update date : 2023.05.25

Packaging

(1) Package quantity : 3,000 (pcs/reel)

(2) Reel Dimensions (unit:mm)

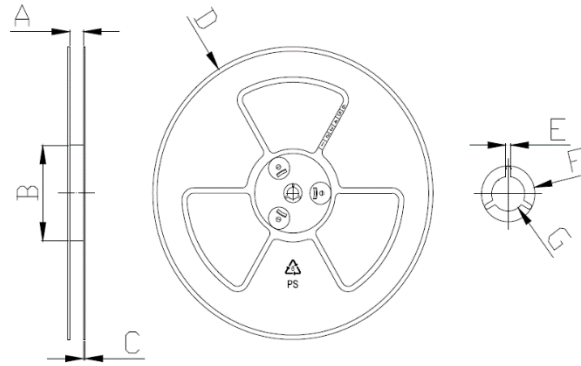

A	B	C	D	E	F	G
12.50	100.0	2.00	330.0	1.90	21.00	13.00
+1.00	+1.50	+0.10	+1.00	+0.40	+0.40	+0.40
-1.00	-1.50	-0.10	-1.00	-0.40	-0.40	-0.40

(3) Tape Dimensions

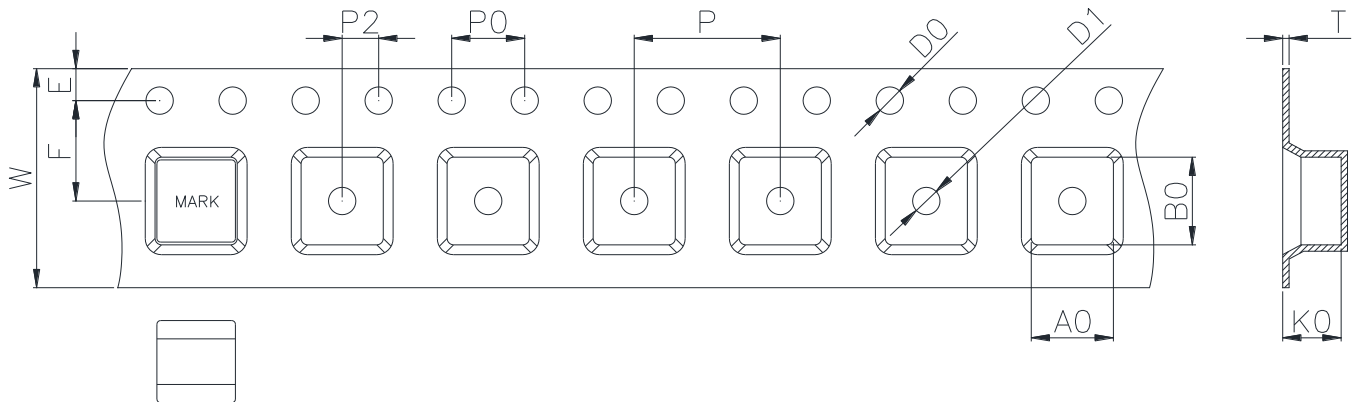

W	A0	B0	K0	E	F	P	P0	P2	D0/D1	T
12.00	4.60	4.90	2.20	1.75	5.50	8.00	4.00	2.00	1.50	0.35
+0.30	+0.10	+0.10	+0.10	+0.15	+0.10	+0.10	+0.10	+0.10	+0.10	+0.05
-0.10	-0.10	-0.10	-0.10	-0.10	-0.10	-0.10	-0.10	-0.10	-0.00	-0.05

Korea Sales Office (KOREA) +82)31-904-1444
 China Sales Office (CHINA) +86)0758-683-1444
 Hungary Sales office (EUROPE) +36)1-404-5832

H.K Sales Office (HONGKONG) +852)2711-5551
 LA Sales Office (USA) +1)714-616-6989

• You can also contact us by e-mail : coilmaster@coilmaster.com

- All specifications are subject to change without notice.
- Update date : 2023.05.25

www.coilmaster.com