

# CMI-CMMP4020HL-B SERIES

## Features

- ▶ Low profile and low DCR
- ▶ Compact design.
- ▶ Metal powder molding type for EMC protection.
- ▶ Available tape and reel for auto insertion.
- ▶ Halogen-Free.
- ▶ RoHS compliant.
- ▶ AEC-Q200 qualified.

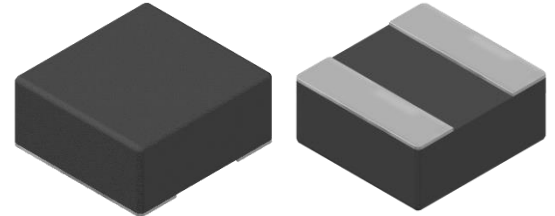

## Applications

- ▶ Car navigation, Car stereo and Car accessories, ADAS ECU, In-C-Vehicle camera (View camera, Sensing camera), Automotive communication module.

## Dimension (Unit:mm)

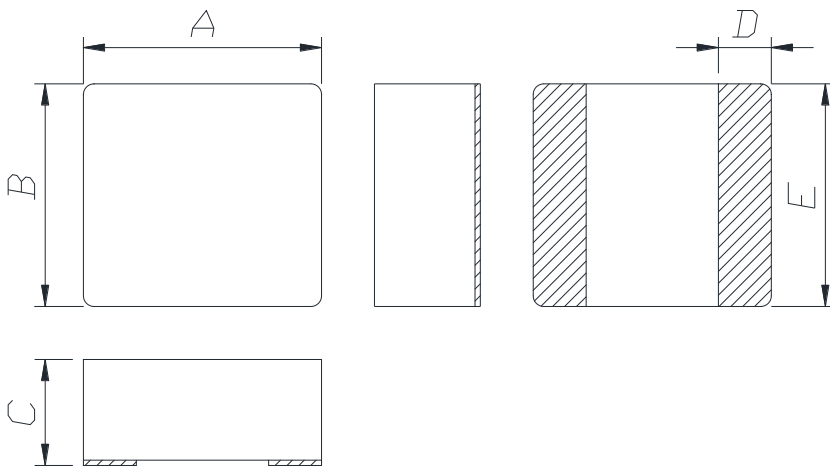

A	B	C	D	E
4.5 ±0.3	4.2 ±0.3	2.0 Max.	1.0 ±0.3	4.2 ±0.3

## Land Pattern (Unit:mm)

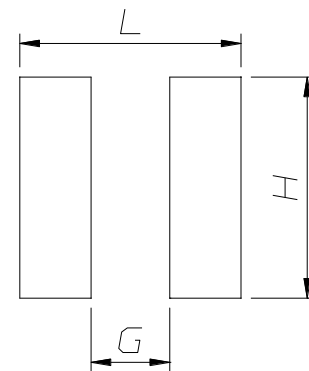

L	G	H
4.5	1.6	4.3

## Regulation of part number

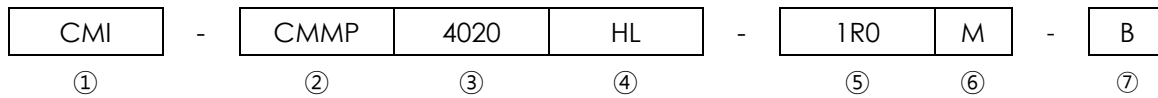

- ① CoilMaster's initial
- ② Series Name : Car Metal Molded Power inductor
- ③ Core Size (unit:mm)
- ④ Type
- ⑤ Typical inductance value (1.0uH)
- ⑥ Inductance tolerance ( $\pm 20\%$ )
- ⑦ Revision (B)

## Specifications

Part Number	Inductance (uH) $\pm 20\%$	DCR(mohm) Max.(Typ.)	Isat(A) Max.(Typ.)	Itemp(A) Max.(Typ.)	Test Frequency (Hz)
CMI-CMMP4020HL-1R0M-B	1.0	20.4(17)	9.5(10.5)	7.5(8.0)	1M
CMI-CMMP4020HL-1R5M-B	1.5	33.6(28)	6.5(7.5)	5.5(6.0)	1M
CMI-CMMP4020HL-2R2M-B	2.2	42(35)	5.5(6.5)	4.7(5.2)	1M
CMI-CMMP4020HL-3R3M-B	3.3	48(40)	5.0(6.0)	4.0(4.5)	1M
CMI-CMMP4020HL-4R7M-B	4.7	52(45)	4.5(5.0)	3.8(4.3)	1M
CMI-CMMP4020HL-6R8M-B	6.8	120(100)	4.0(4.5)	2.8(3.0)	1M
CMI-CMMP4020HL-8R2M-B	8.2	138(115)	3.0(3.5)	2.6(2.8)	1M
CMI-CMMP4020HL-100M-B	10	150(125)	2.8(3.3)	2.0(2.2)	1M

- Isat: When based on the inductance change rate (Approximately 30% below in the initial value)
- Itemp: When based on the temperature increase (Temperature increase of approximately 40°C by self heating)
- Operating Temperature Range (including self temperature) : -40°C ~ +150 °c

Note 1 : Circuit design, component placement, PCB trace size and thickness, airflow and other cooling. Provision all affect the part Temperature. Part temperature should be verified in the end application.

▪ **You can also contact us by e-mail : [coilmaster@coilmaster.com](mailto:coilmaster@coilmaster.com)**

- All specifications are subject to change without notice.
- Update date : 2023.05.25

[www.coilmaster.com](http://www.coilmaster.com)

# Electrical characteristics

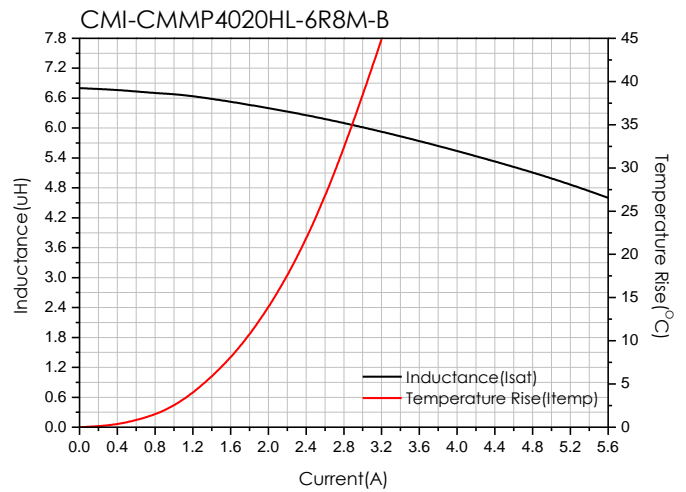
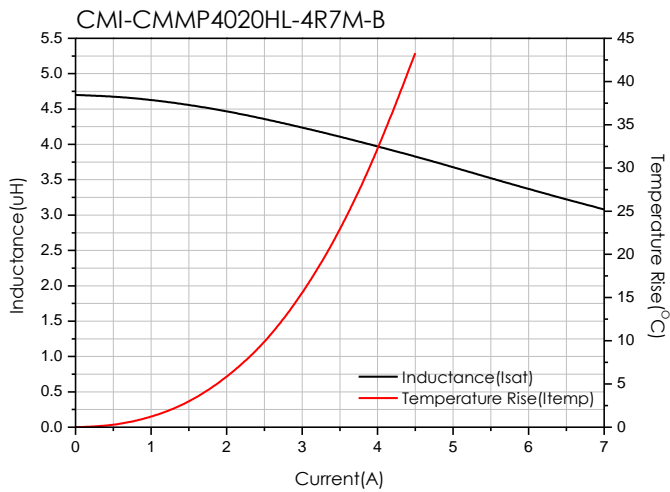
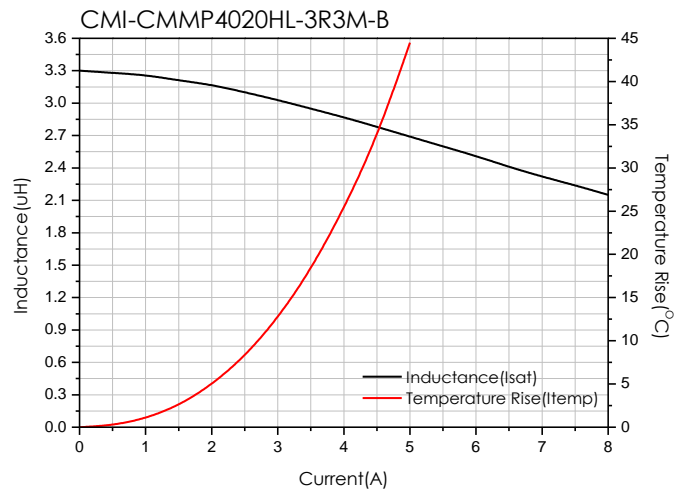
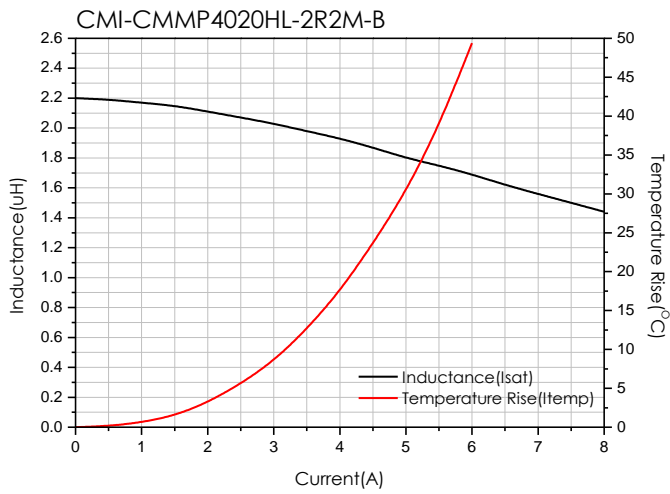
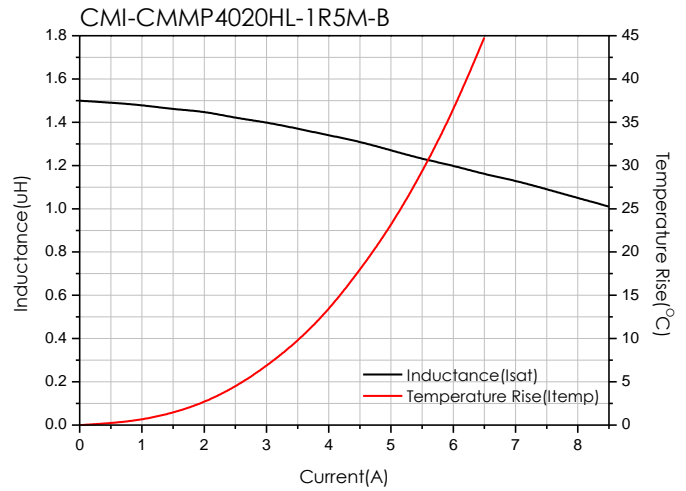
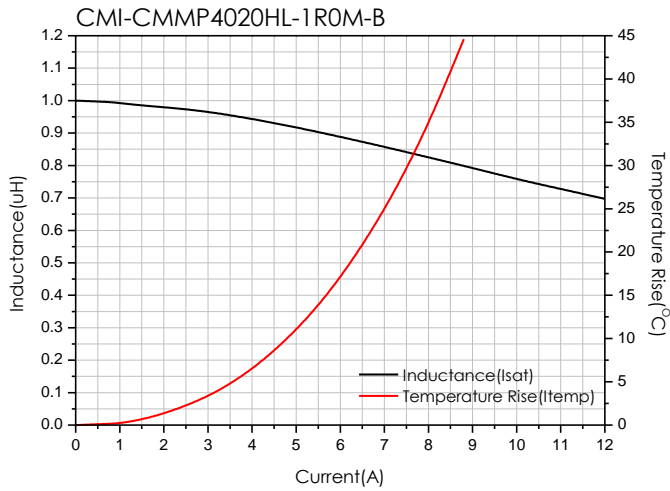

- You can also contact us by e-mail : [coilmaster@coilmaster.com](mailto:coilmaster@coilmaster.com)
- All specifications are subject to change without notice.
- Update date : 2023.05.25

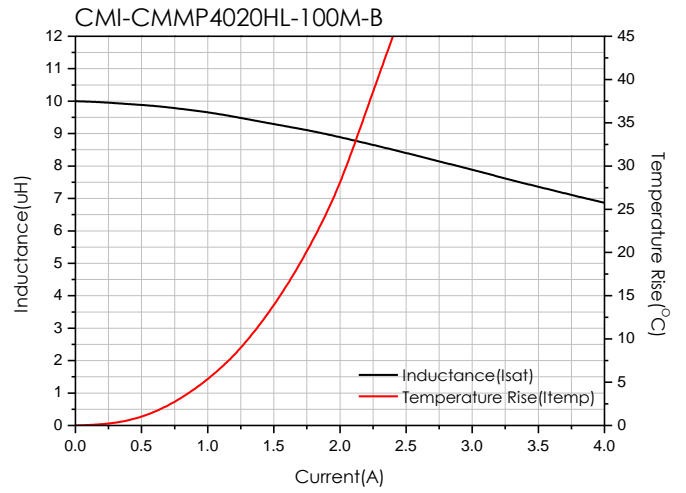
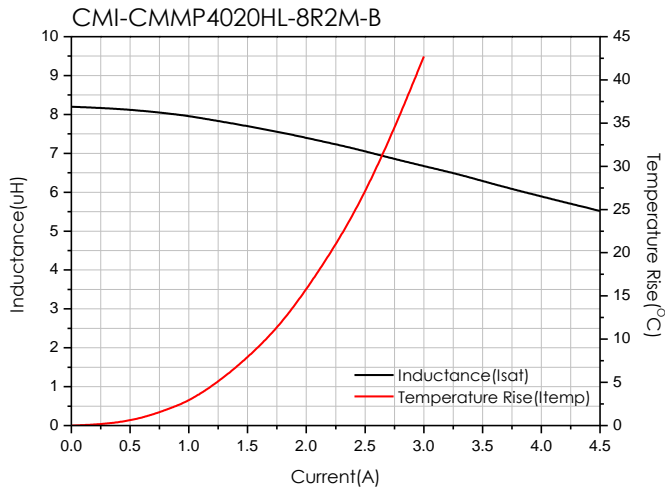

- You can also contact us by e-mail : [coilmaster@coilmaster.com](mailto:coilmaster@coilmaster.com)
- All specifications are subject to change without notice.
- Update date : 2023.05.25

## Packaging

(1) Package quantity : 3,000 (pcs/reel)

(2) Reel Dimensions (unit:mm)

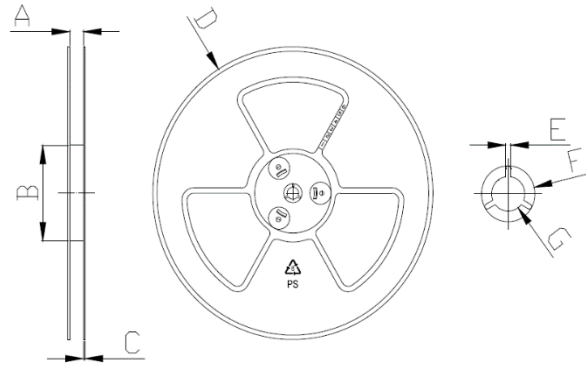

A	B	C	D	E	F	G
12.50	100.0	2.00	330.0	1.90	21.00	13.00
+1.00	+1.50	+0.10	+1.00	+0.40	+0.40	+0.40
-1.00	-1.50	-0.10	-1.00	-0.40	-0.40	-0.40

(3) Tape Dimensions

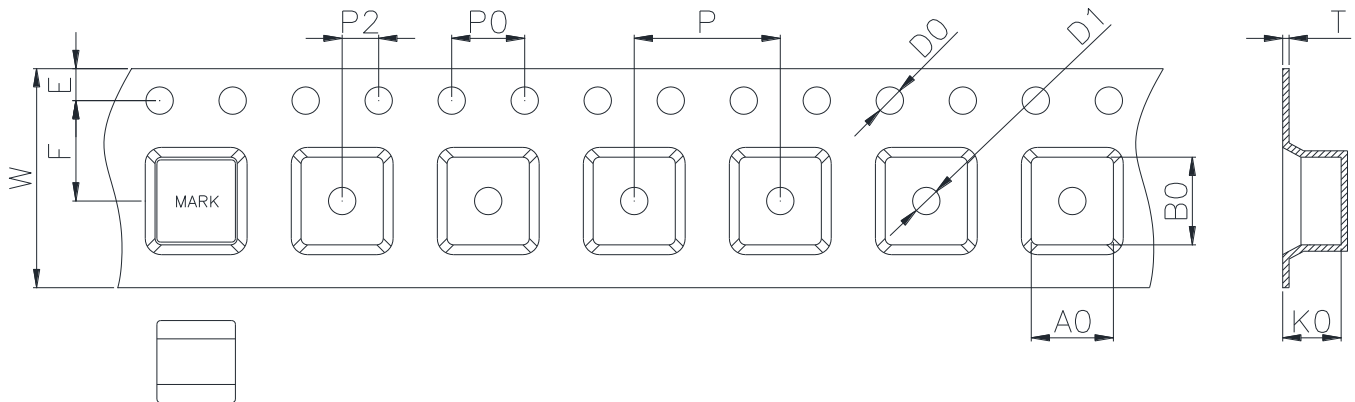

W	A0	B0	K0	E	F	P	P0	P2	D0/D1	T
12.00	4.60	4.90	2.20	1.75	5.50	8.00	4.00	2.00	1.50	0.35
+0.30	+0.10	+0.10	+0.10	+0.15	+0.10	+0.10	+0.10	+0.10	+0.10	+0.05
-0.10	-0.10	-0.10	-0.10	-0.10	-0.10	-0.10	-0.10	-0.10	-0.00	-0.05

Korea Sales Office (KOREA) +82)31-904-1444  
 China Sales Office (CHINA) +86)0758-683-1444  
 Hungary Sales office (EUROPE) +36)1-404-5832

H.K Sales Office (HONGKONG) +852)2711-5551  
 LA Sales Office (USA) +1)714-616-6989

• You can also contact us by e-mail : [coilmaster@coilmaster.com](mailto:coilmaster@coilmaster.com)

- All specifications are subject to change without notice.
- Update date : 2023.05.25

[www.coilmaster.com](http://www.coilmaster.com)