

CMI-CMMP7030HL-A SERIES

Features

- ▶ High current and Compact design.
- ▶ Metal powder molding type for EMC protection.
- ▶ Available tape and reel for auto insertion.
- ▶ Halogen-Free.
- ▶ RoHS compliant.
- ▶ AEC-Q200 qualified.

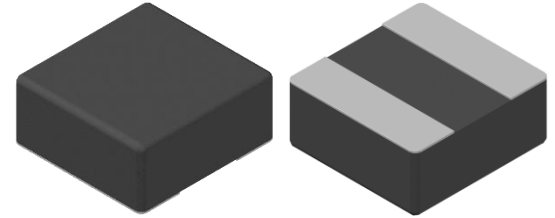

Applications

- ▶ Car navigation, Car stereo and Car accessories, ADAS ECU, In-C-Vehicle camera (View camera, Sensing camera), Automotive communication module.

Dimension (Unit:mm)

Land Pattern (Unit:mm)

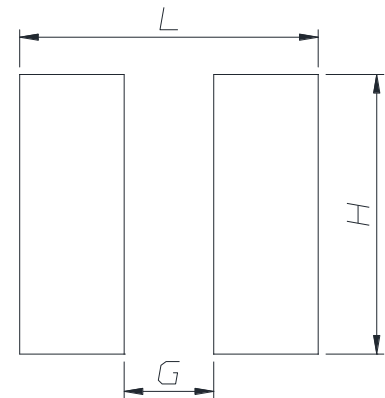
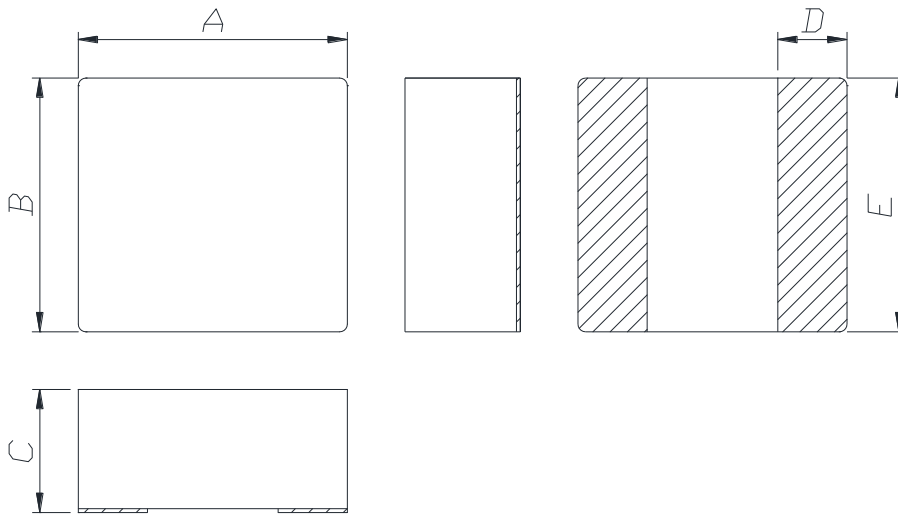

A	B	C	D	E
7.0 ±0.3	6.6 ±0.3	3.0 Max.	1.8 ±0.3	6.6 ±0.3

L	G	H
8.0	2.4	7.5

Regulation of part number

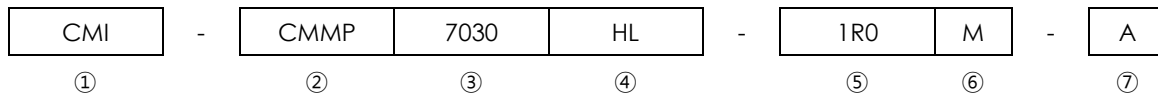

- ① CoilMaster's initial
- ② Series Name : Car Metal Molded Power inductor
- ③ Core Size (unit:mm)
- ④ Type
- ⑤ Typical inductance value (1.0uH)
- ⑥ Inductance tolerance ($\pm 20\%$)
- ⑦ Revision (A)

Specifications

Part Number	Inductance (uH) $\pm 20\%$	DCR(mohm) Max.(Typ.)	Isat(A) Max.(Typ.)	Itemp(A) Max.(Typ.)	Test Frequency (Hz)
CMI-CMMP7030HL-1R0M-A	1.0	9(7.5)	19.0(21.0)	12.0(13.0)	1M
CMI-CMMP7030HL-1R5M-A	1.5	14.4(12)	17.0(19.0)	11.0(12.0)	1M
CMI-CMMP7030HL-2R2M-A	2.2	15.6(13)	13.0(15.0)	9.5(10.5)	1M
CMI-CMMP7030HL-3R3M-A	3.3	30(25)	10.0(12.0)	7.5(8.0)	1M
CMI-CMMP7030HL-4R7M-A	4.7	42(35)	9.0(11.0)	6.5(7.0)	1M
CMI-CMMP7030HL-6R8M-A	6.8	48(40)	7.5(8.5)	5.5(6.0)	1M
CMI-CMMP7030HL-100M-A	10	72(60)	6.6(7.6)	4.0(4.5)	1M
CMI-CMMP7030HL-150M-A	15	120(100)	6.0(7.0)	3.4(3.6)	1M
CMI-CMMP7030HL-220M-A	22	168(140)	4.7(5.2)	2.8(3.0)	1M

- Isat: When based on the inductance change rate (Approximately 30% below in the initial value)
- Itemp: When based on the temperature increase (Temperature increase of approximately 40°C by self heating)
- Operating Temperature Range (including self temperature) : -40°C ~ +150 °c

Note 1 : Circuit design, component placement, PCB trace size and thickness, airflow and other cooling. Provision all affect the part Temperature. Part temperature should be verified in the end application.

▪ **You can also contact us by e-mail : coilmaster@coilmaster.com**

- All specifications are subject to change without notice.
- Update date : 2023.05.25

www.coilmaster.com

Electrical characteristics

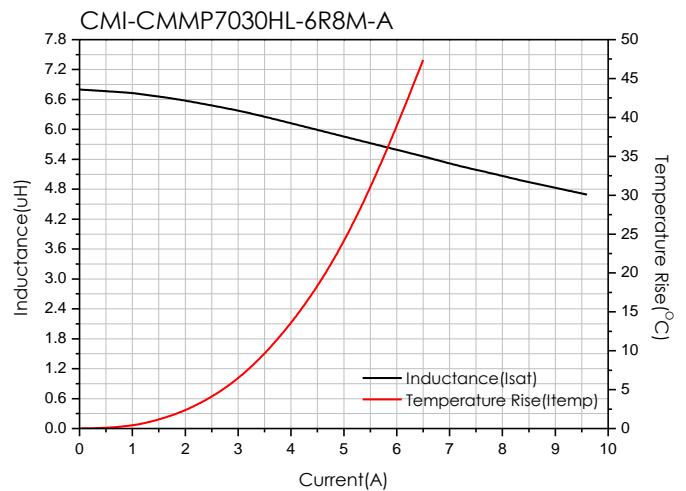
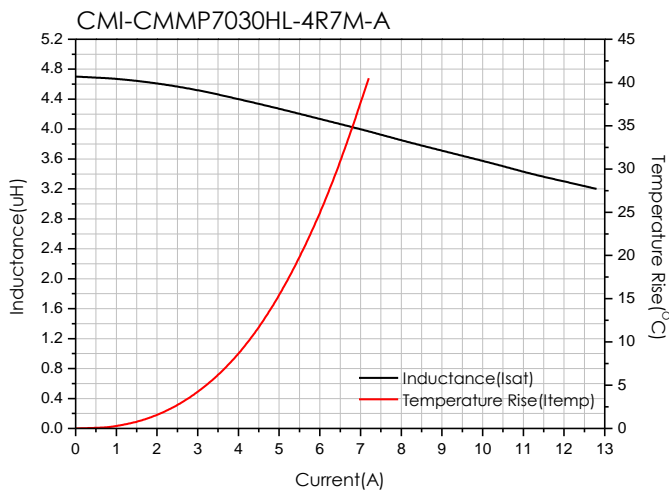
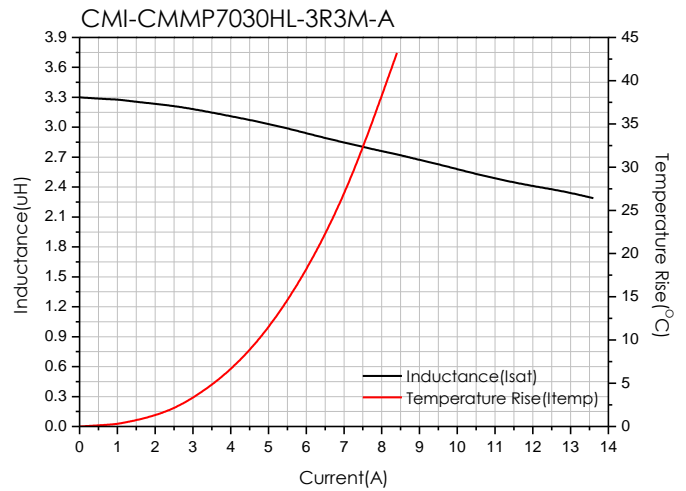
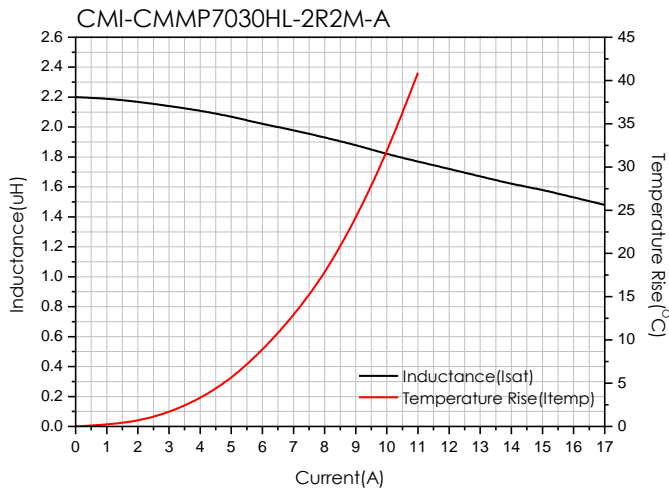
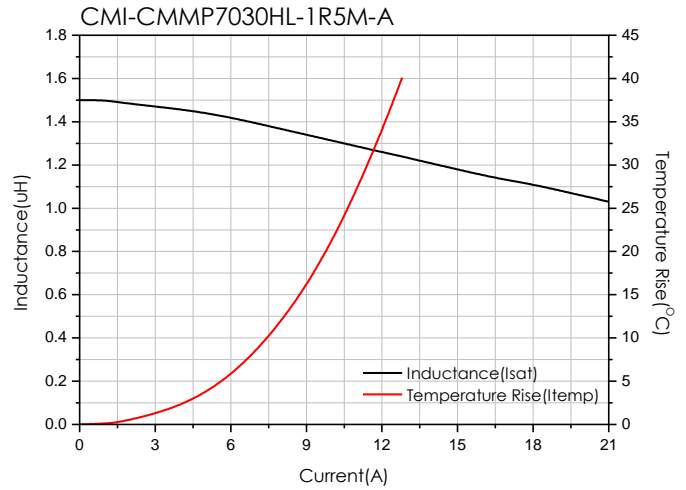
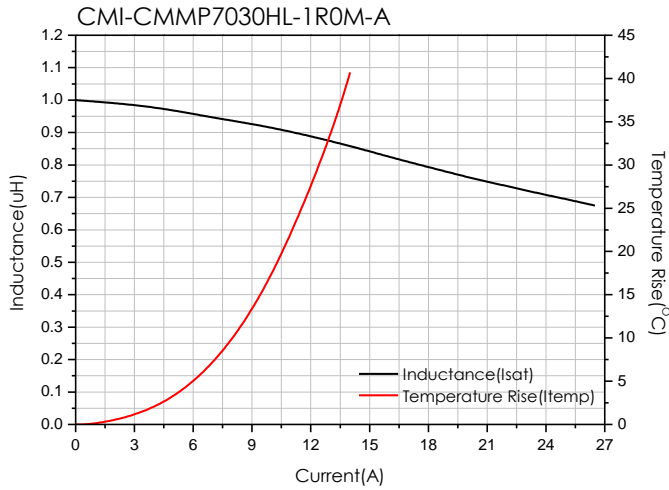

- You can also contact us by e-mail : coilmaster@coilmaster.com
- All specifications are subject to change without notice.
- Update date : 2023.05.25

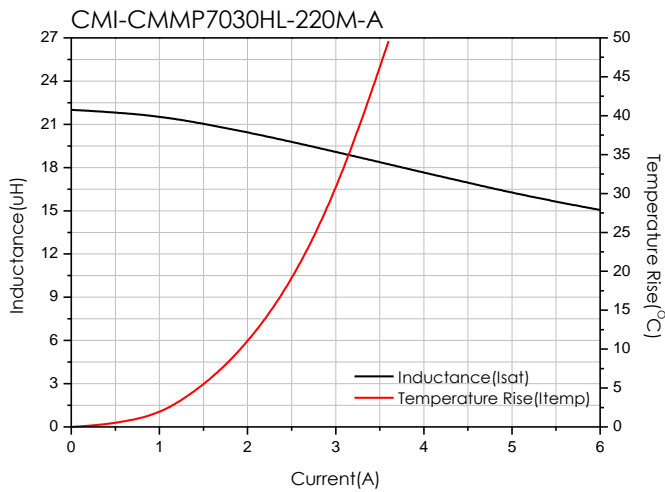
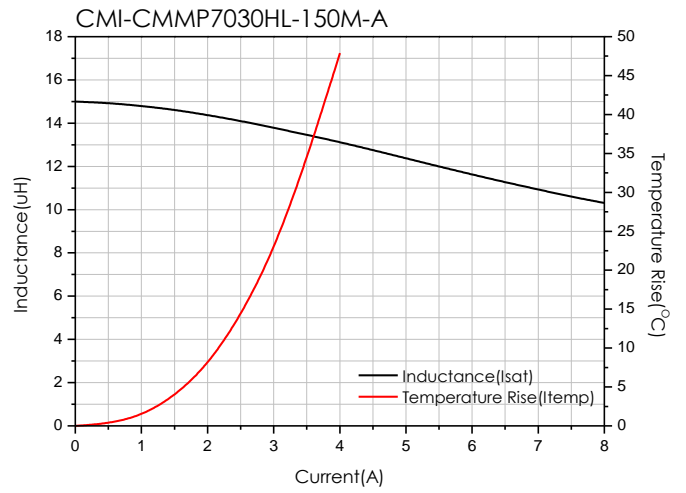
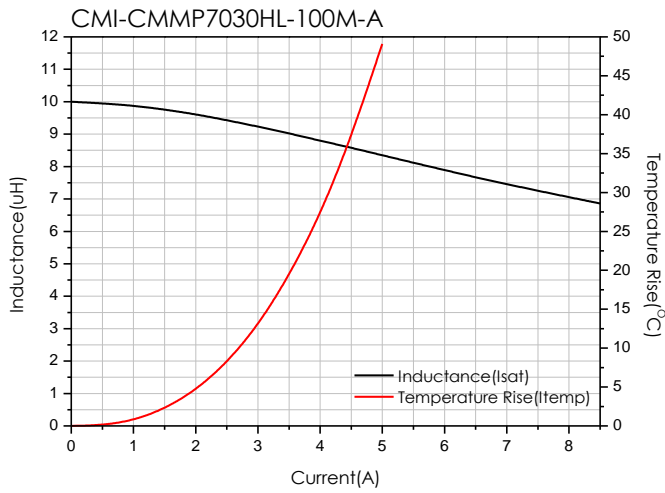

- You can also contact us by e-mail : coilmaster@coilmaster.com
- All specifications are subject to change without notice.
- Update date : 2023.05.25

Packaging

(1) Package quantity : 1,000 (pcs/reel)

(2) Reel Dimensions (unit:mm)

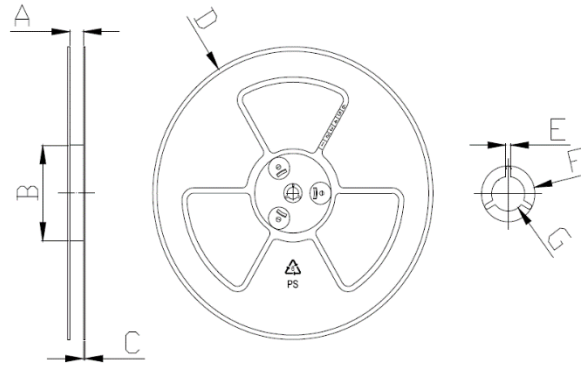

A	B	C	D	E	F	G
16.50	100.0	2.00	330.0	2.30	21.50	13.00
+0.50	+1.00	+0.10	+3.00	+0.30	+0.30	+0.50
-0.50	-1.00	-0.10	-3.00	-0.30	-0.30	-0.20

(3) Tape Dimensions

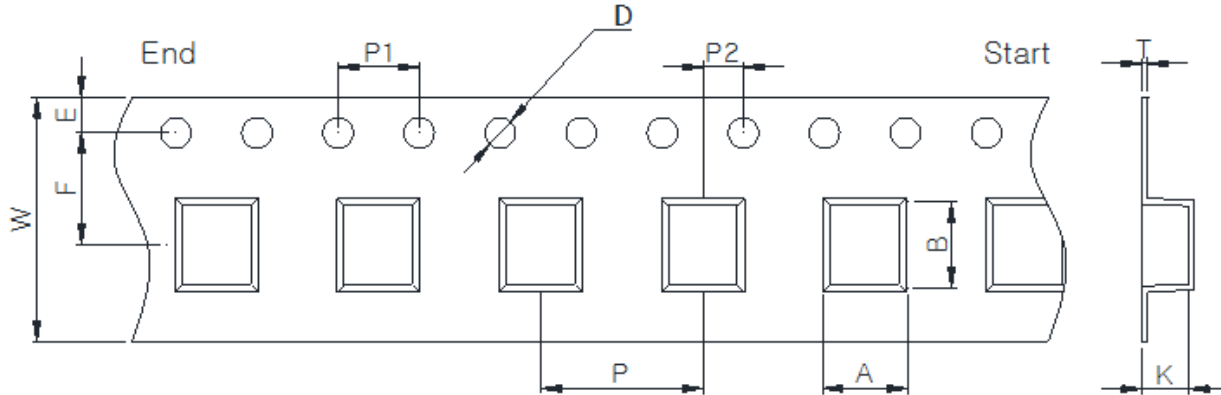

W	A	B	K	E	F	P	P1	P2	D	T
16.00	7.00	7.50	3.20	1.75	7.50	12.00	4.00	2.00	1.50	0.35
+0.30	+0.10	+0.10	+0.10	+0.10	+0.10	+0.10	+0.10	+0.10	+0.10	+0.05
-0.10	-0.10	-0.10	-0.10	-0.10	-0.10	-0.10	-0.10	-0.10	-0.00	-0.05

Korea Sales Office (KOREA) +82)31-904-1444
 China Sales Office (CHINA) +86)0758-683-1444
 Hungary Sales office (EUROPE) +36)1-404-5832

H.K Sales Office (HONGKONG) +852)2711-5551
 LA Sales Office (USA) +1)714-616-6989

• You can also contact us by e-mail : coilmaster@coilmaster.com

- All specifications are subject to change without notice.
- Update date : 2023.05.25

www.coilmaster.com