

# CMI-CMMPF6060QL-SB SERIES

## Features

- ▶ Metal powder molding type for EMC protection.
- ▶ Lower DCR with applying flat wire.
- ▶ Available tape and reel for auto insertion.
- ▶ Halogen-Free.
- ▶ RoHS compliant.
- ▶ AEC-Q200 qualified.

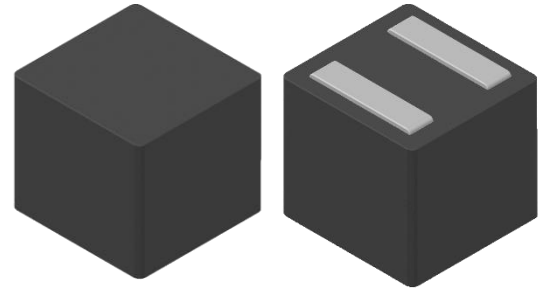

## Applications

- ▶ Equipment using for automobiles (ECM, Airbags, Headlights, Electronic Power steering, Motors, ABS, other)

## Dimension (Unit:mm)

## Land Pattern (Unit:mm)

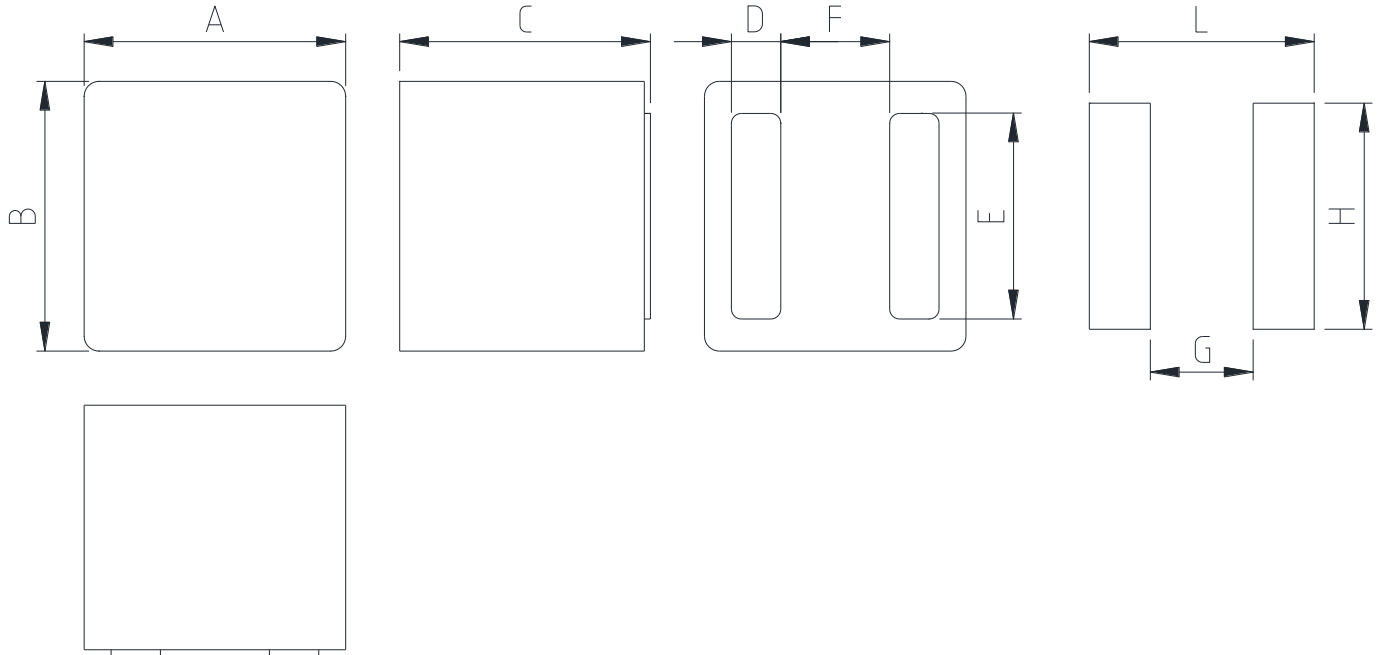

A	B	C	D	E	F	G	H	L
6.5 ±0.3	6.7 ±0.3	6.1 Max.	1.2 ±0.2	5.0 Typ.	2.6 Typ.	2.50	5.50	5.47

- You can also contact us by e-mail : [coilmaster@coilmaster.com](mailto:coilmaster@coilmaster.com)
- All specifications are subject to change without notice.
- Update date : 2024.06.12

## Regulation of part number

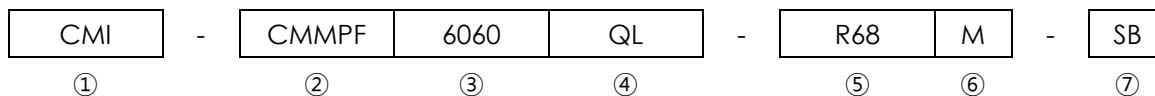

- ① CoilMaster's initial
- ② Series Name : Car Metal Molded Power inductor Flat wire type.
- ③ Core Size (unit:mm)
- ④ Material
- ⑤ Typical inductance value (0.68uH)
- ⑥ Inductance tolerance ( $\pm 20\%$ )
- ⑦ Type (SB)

## Specifications

Part Number	Inductance (uH) $\pm 20\%$	DCR(mohm) Max.(Typ.)	Isat(A) Max.(Typ.)	Itemp(A) Max.(Typ.)	Test Frequency (Hz)
CMI-CMMPF6060QL-R68M-SB	0.68	3.36(2.8)	30.0(35.0)	20.0(21.0)	1M
CMI-CMMPF6060QL-2R2M-SB	2.2	4.8(4.0)	14.0(16.0)	16.5(17.5)	1M
CMI-CMMPF6060QL-3R3M-SB	3.3	10.8(9.0)	13.0(14.0)	12.0(12.5)	1M
CMI-CMMPF6060QL-4R7M-SB	4.7	16.2(13.5)	10.0(11.0)	9.2(9.7)	1M
CMI-CMMPF6060QL-5R6M-SB	5.6	16.8(14)	9.0(10.5)	9.0(9.5)	1M
CMI-CMMPF6060QL-6R8M-SB	6.8	21(18)	8.6(9.5)	7.6(8.0)	1M
CMI-CMMPF6060QL-8R2M-SB	8.2	30(25)	7.5(8.5)	6.0(6.5)	1M
CMI-CMMPF6060QL-100M-SB	10.0	36(30)	7.0(7.5)	5.7(6.2)	1M
CMI-CMMPF6060QL-150M-SB	15.0	48.6(40.5)	5.5(6.0)	5.0(5.5)	1M
CMI-CMMPF6060QL-220M-SB	22.0	60(50)	5.0(5.6)	4.5(5.0)	1M

- Isat: When based on the inductance change rate (Approximately 30% below in the initial value)
- Itemp: When based on the temperature increase (Temperature increase of approximately 40°C by self heating)
- Operating Temperature Range (including self temperature) : -40°C ~ +165 °c

Note 1 : Circuit design, component placement, PCB trace size and thickness, airflow and other cooling. Provision all affect the part Temperature. Part temperature should be verified in the end application.

▪ **You can also contact us by e-mail : [coilmaster@coilmaster.com](mailto:coilmaster@coilmaster.com)**

- All specifications are subject to change without notice.
- Update date : 2024.06.12

[www.coilmaster.com](http://www.coilmaster.com)

## Electrical characteristics

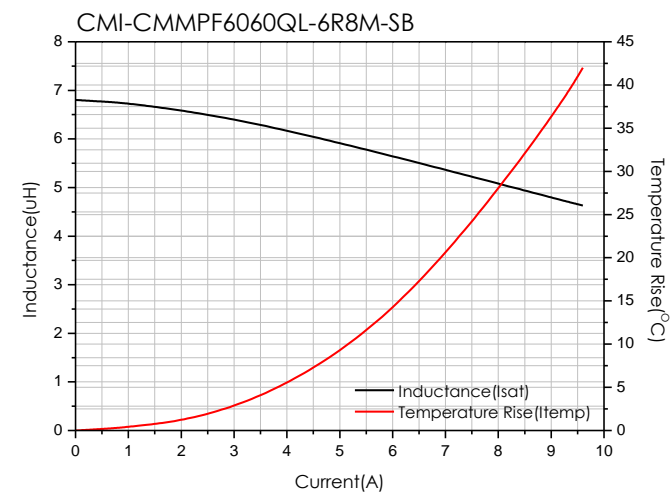
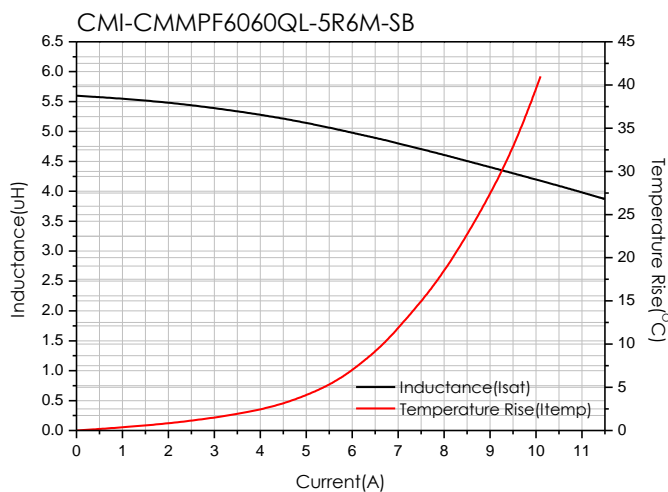
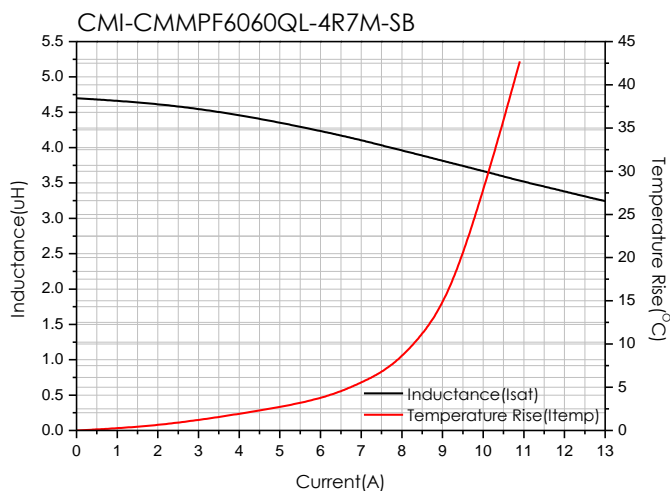
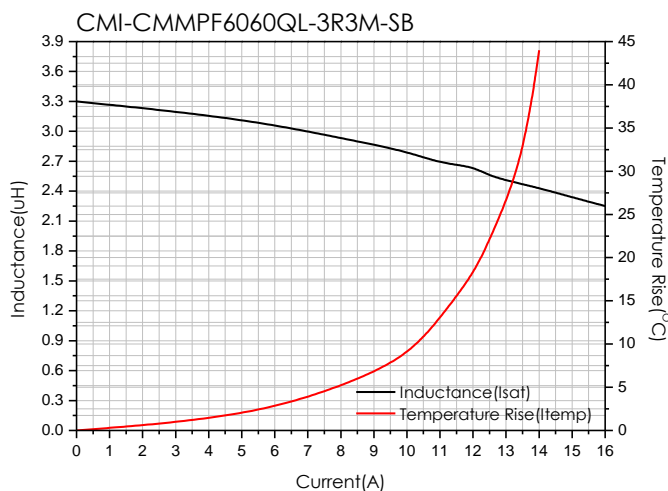
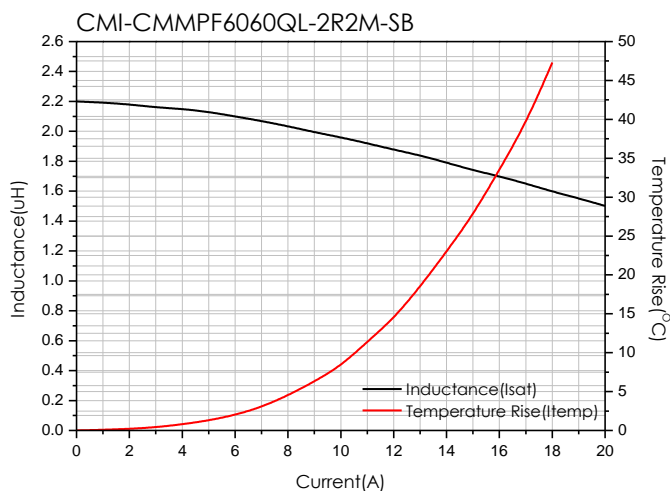
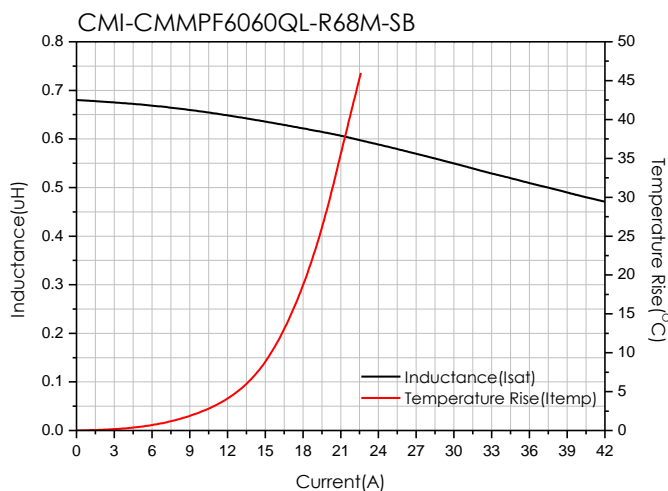

- You can also contact us by e-mail : [coilmaster@coilmaster.com](mailto:coilmaster@coilmaster.com)
- All specifications are subject to change without notice.
- Update date : 2024.06.12

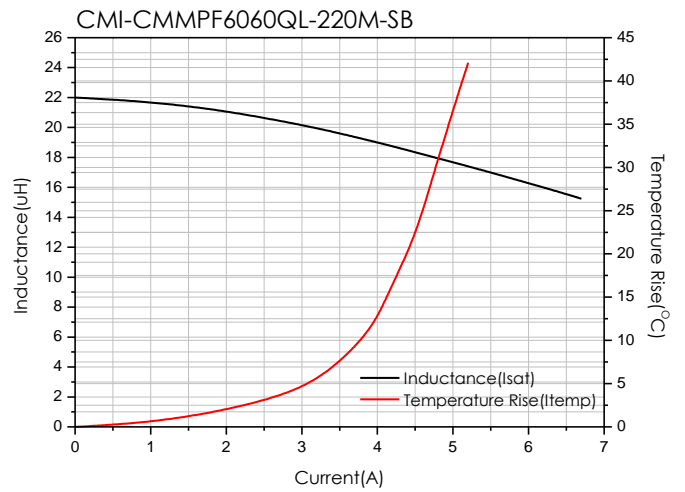
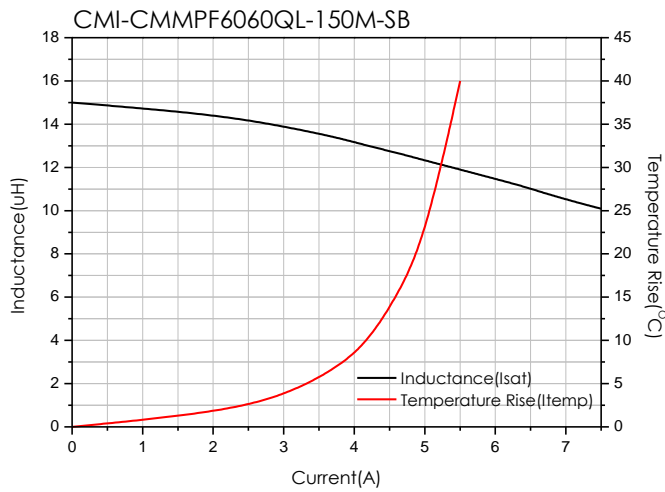
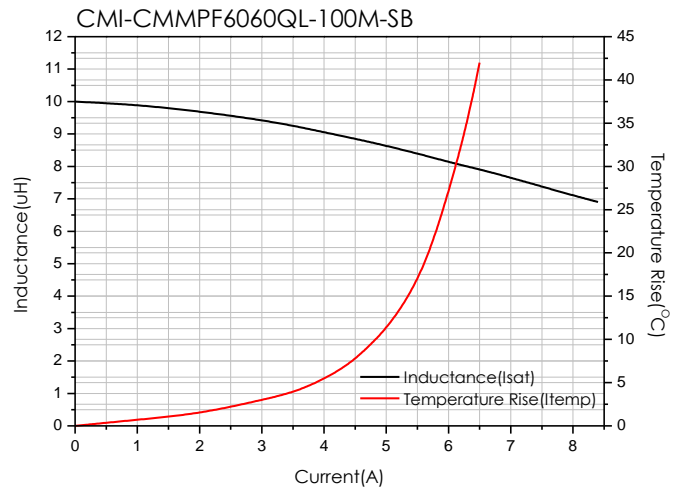
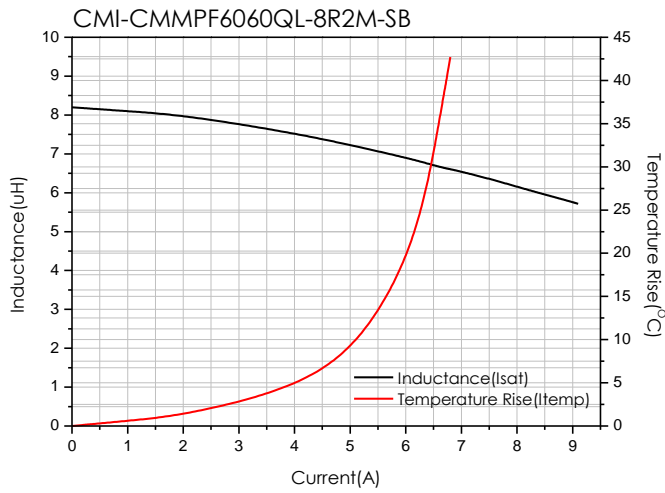

- You can also contact us by e-mail : [coilmaster@coilmaster.com](mailto:coilmaster@coilmaster.com)
- All specifications are subject to change without notice.
- Update date : 2024.06.12

## Packaging

(1) Package quantity : 750 (pcs/reel)

(2) Reel Dimensions (unit:mm)

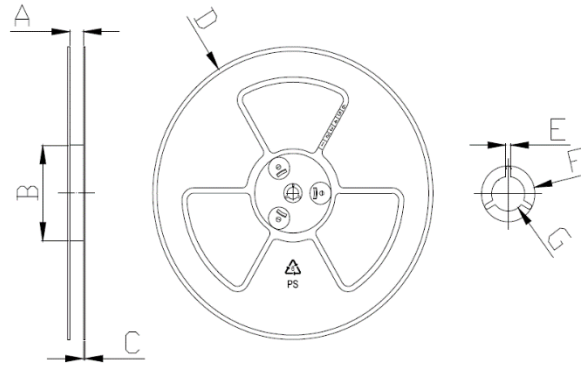

A	B	C	D	E	F	G
16.50	100.0	2.00	330.0	2.30	21.50	13.00
+0.50	+1.00	+0.20	+3.00	+0.30	+0.30	+0.50
-0.50	-1.00	-0.20	-3.00	-0.30	-0.30	-0.20

(3) Tape Dimensions

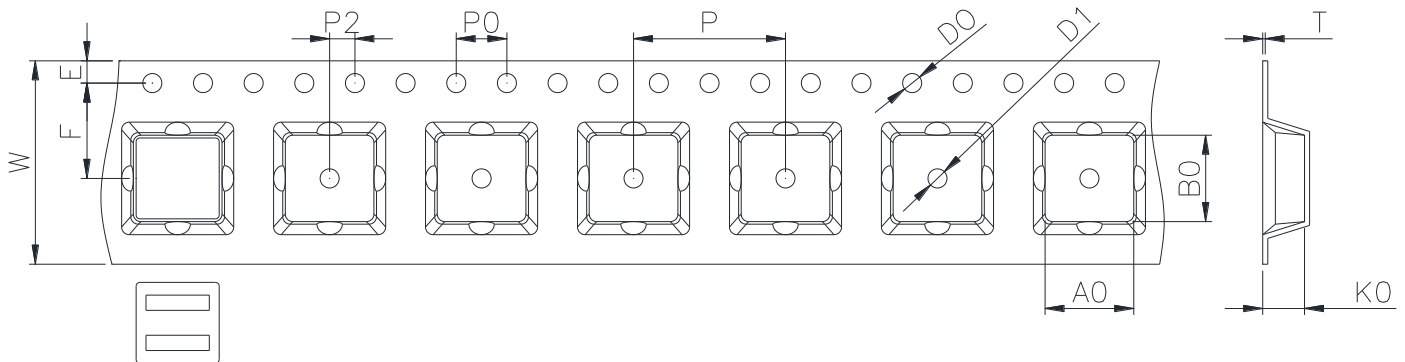

W	A0	B0	KO	E	F	P	P0	P2	D0/D1	T
16.00	7.00	6.80	6.30	1.75	7.50	12.00	4.00	2.00	1.50	0.40
+0.30	+0.10	+0.10	+0.10	+0.10	+0.10	+0.10	+0.10	+0.10	+0.10	+0.05
-0.10	-0.10	-0.10	-0.10	-0.10	-0.10	-0.10	-0.10	-0.10	-0.00	-0.05

Korea Sales Office (KOREA) +82)31-904-1444  
 China Sales Office (CHINA) +86)0758-683-1444  
 Hungary Sales office (EUROPE) +36)1-404-5832

H.K Sales Office (HONGKONG) +852)2711-5551  
 LA Sales Office (USA) +1)714-616-6989

• You can also contact us by e-mail : [coilmaster@coilmaster.com](mailto:coilmaster@coilmaster.com)

- All specifications are subject to change without notice.
- Update date : 2024.06.12

[www.coilmaster.com](http://www.coilmaster.com)