

CMI-CMMPP10030HL-SERIES

Features

- ▶ Metal powder molding type for EMC protection.
- ▶ Available tape and reel for auto insertion.
- ▶ Halogen-Free.
- ▶ RoHS compliant.
- ▶ AEC-Q200 qualified.

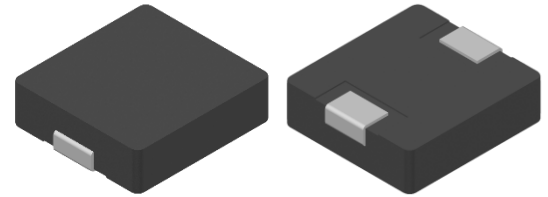

Applications

- ▶ Equipment using for automobiles (ECM, Airbags, Headlights, Electronic Power steering, Motors, ABS, other)

Dimension (Unit:mm)

Land Pattern (Unit:mm)

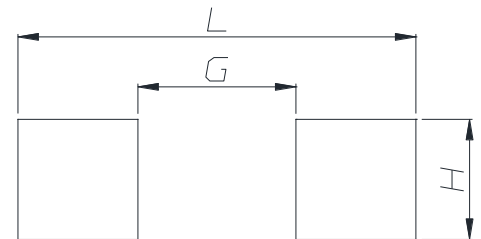
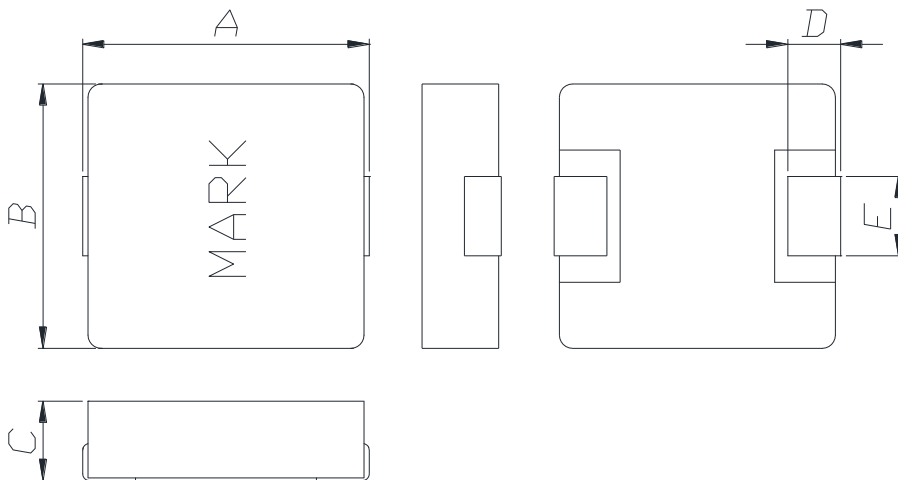

A	B	C	D	E
10.85 ±0.5	10.0 ±0.4	3.0 Max.	2.0 ±0.3	3.0 ±0.2

L	G	H
13.6	5.4	4.1

Regulation of part number

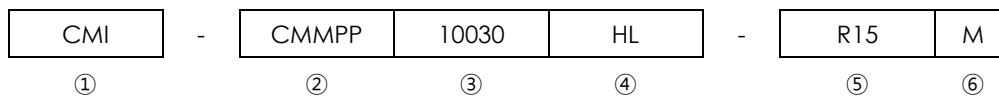

- ① CoilMaster's initial
- ② Series Name : Car Metal Molded Pin type Power inductor
- ③ Core Size (unit:mm)
- ④ Material
- ⑤ Typical inductance value (0.15uH)
- ⑥ Inductance tolerance ($\pm 20\%$)

Specifications

Part Number	Inductance (uH) $\pm 20\%$	DCR(mohm) Max.(Typ.)	Isat(A) Max.(Typ.)	Itemp(A) Max.(Typ.)	Test Frequency (Hz)
CMI-CMMPP10030HL-R15M	0.15	0.9(0.6)	60.0(65.0)	34.0(36.0)	1M
CMI-CMMPP10030HL-R22M	0.22	1.8(1.5)	55.0(60.0)	32.0(34.0)	1M
CMI-CMMPP10030HL-R33M	0.33	2.4(2)	50.0(55.0)	30.0(32.0)	1M
CMI-CMMPP10030HL-R47M	0.47	3(2.5)	44.0(49.0)	29.0(31.0)	1M
CMI-CMMPP10030HL-R56M	0.56	3.4(2.8)	40.0(45.0)	28.0(30.0)	1M
CMI-CMMPP10030HL-2R2M	2.2	11.4(9.5)	17.0(20.0)	10.5(11.5)	1M
CMI-CMMPP10030HL-3R3M	3.3	24(20)	14.0(15.0)	8.5(9.0)	1M
CMI-CMMPP10030HL-6R8M	6.8	42(35)	7.5(8.5)	6.5(7.0)	1M
CMI-CMMPP10030HL-220M	22.0	108(90)	5.0(5.5)	5.0(5.5)	1M

- Isat: When based on the inductance change rate (Approximately 30% below in the initial value)
- Itemp: When based on the temperature increase (Temperature increase of approximately 40°C by self heating)
- Operating Temperature Range (including self temperature) : -40°C ~ +165 °C

Note 1 : Circuit design, component placement, PCB trace size and thickness, airflow and other cooling. Provision all affect the part Temperature. Part temperature should be verified in the end application.

▪ **You can also contact us by e-mail : coilmaster@coilmaster.com**

- All specifications are subject to change without notice.
- Update date : 2022.08.10

www.coilmaster.com

Electrical characteristics

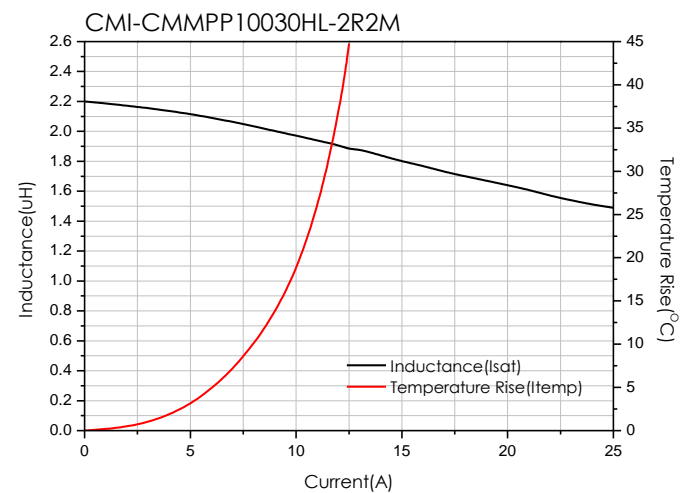
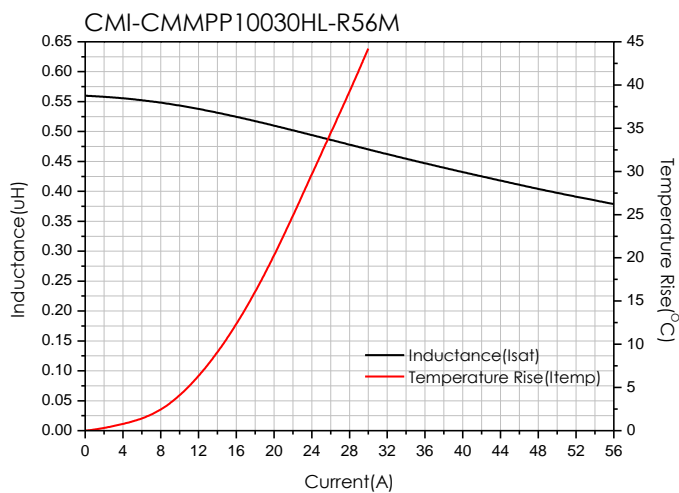
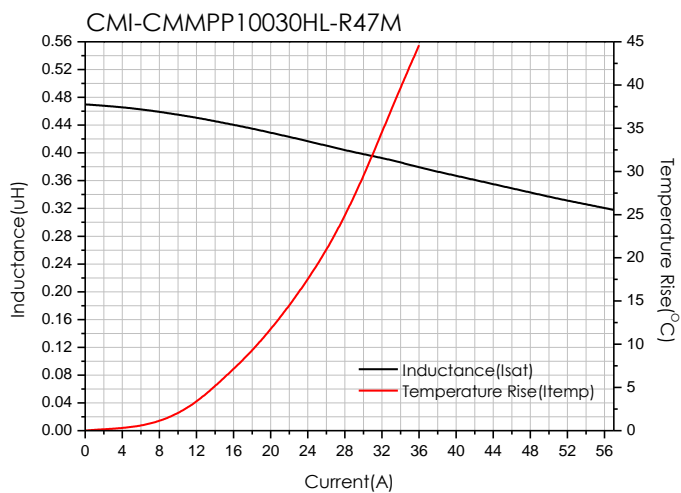
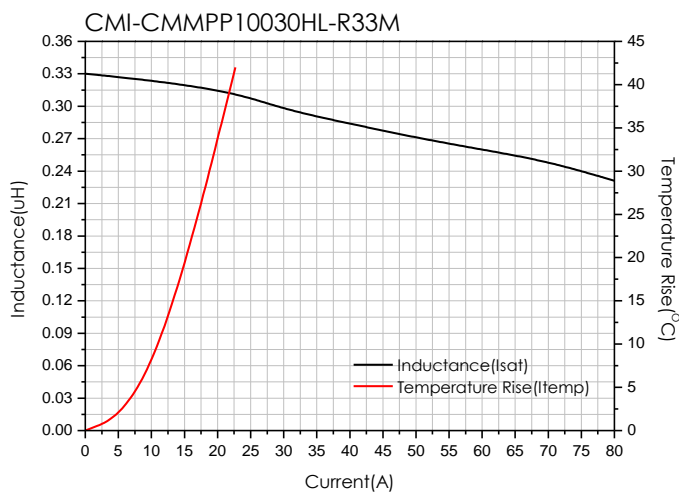
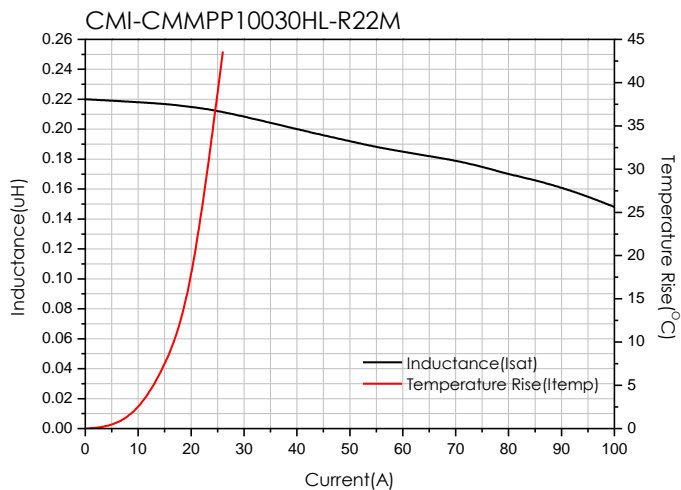
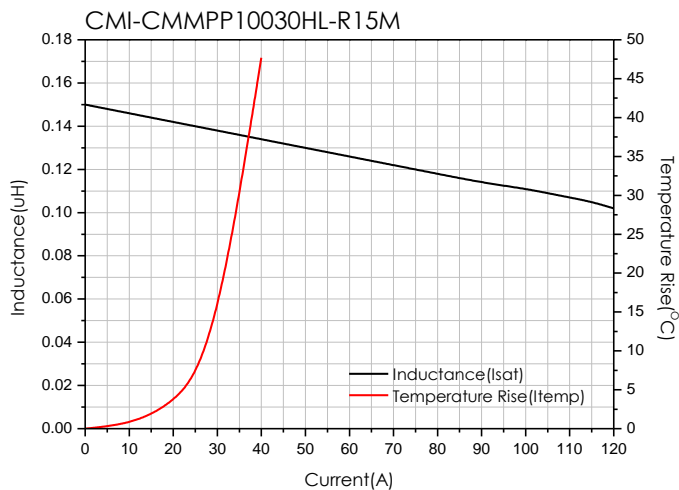

- You can also contact us by e-mail : coilmaster@coilmaster.com
- All specifications are subject to change without notice.
- Update date : 2022.08.10

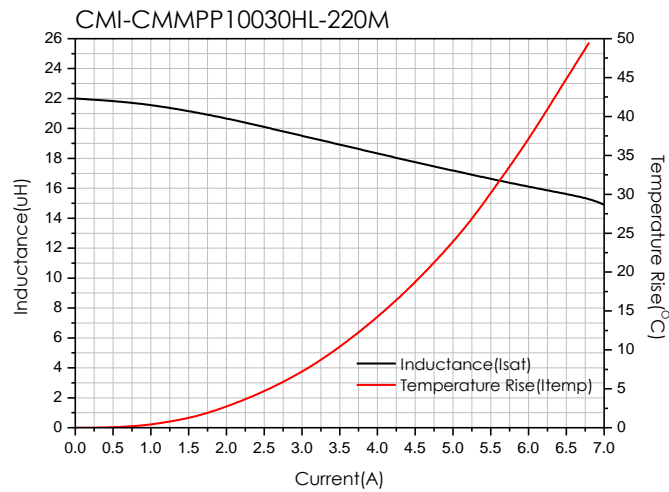
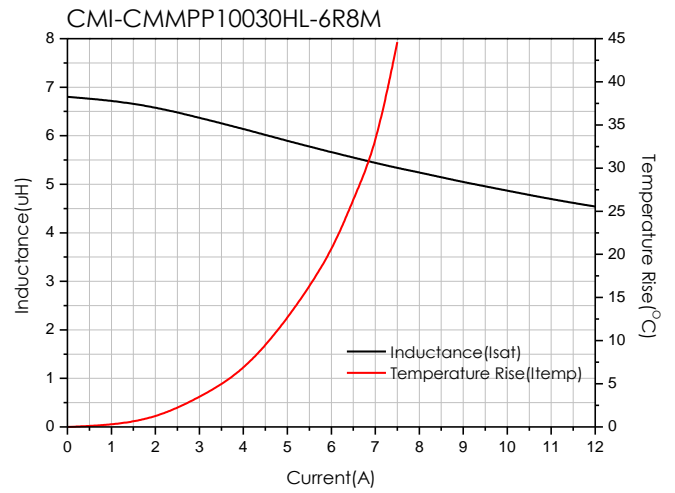
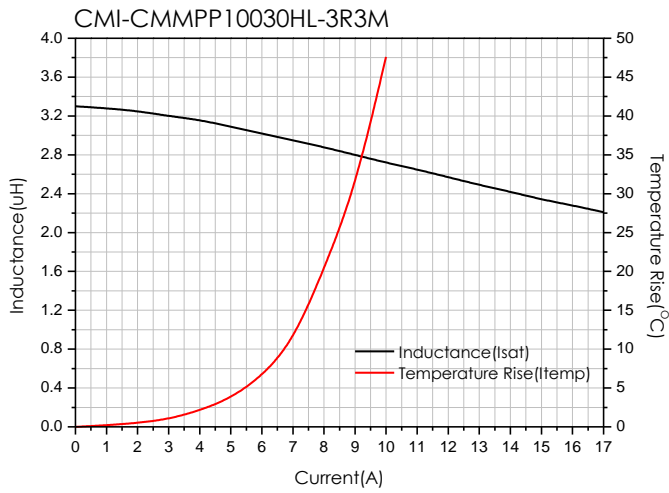

- You can also contact us by e-mail : coilmaster@coilmaster.com
- All specifications are subject to change without notice.
- Update date : 2022.08.10

Packaging

(1) Package quantity : 1,000 (pcs/reel)

(2) Reel Dimensions (unit:mm)

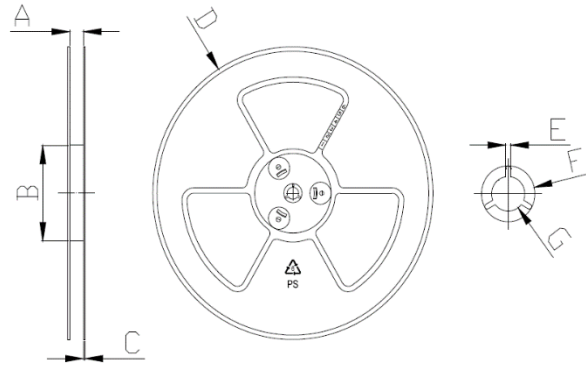

A	B	C	D	E	F	G
24.50	100.0	2.30	330.0	2.30	21.50	13.00
+0.50	+1.00	+0.20	+3.00	+0.30	+0.30	+0.50
-0.50	-1.00	-0.20	-3.00	-0.30	-0.30	-0.20

(3) Tape Dimensions

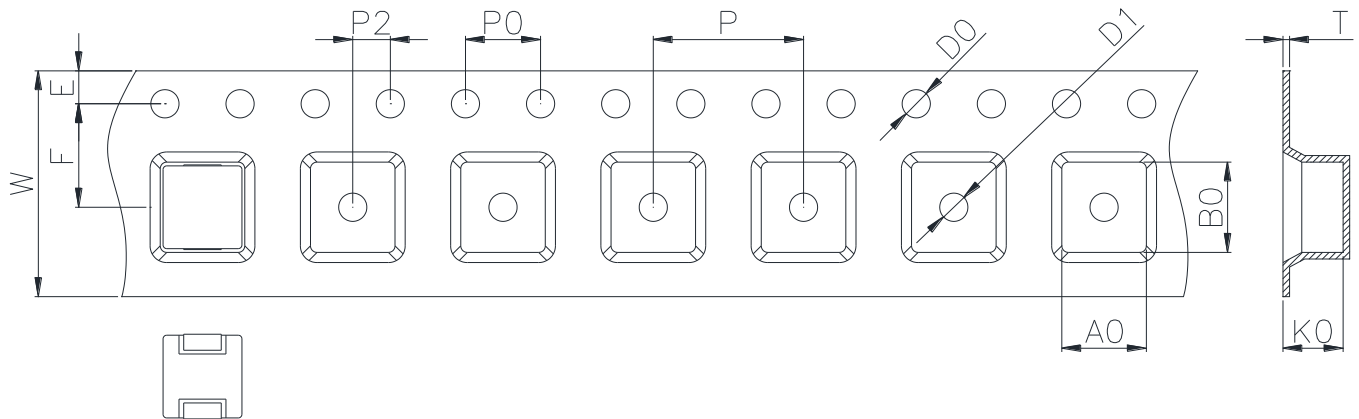

W	A0	B0	K0	E	F	P	P0	P2	D0/D1	T
24.00	10.50	11.30	3.20	1.75	11.50	16.00	4.00	2.00	1.50	0.35
+0.30	+0.10	+0.10	+0.10	+0.10	+0.10	+0.10	+0.10	+0.10	+0.10	+0.05
-0.10	-0.10	-0.00	-0.10	-0.10	-0.10	-0.10	-0.10	-0.10	-0.00	-0.05

Korea Sales Office (KOREA) +82)31-904-1444
 China Sales Office (CHINA) +86)0758-683-1444
 Hungary Sales office (EUROPE) +36)1-404-5832

H.K Sales Office (HONGKONG) +852)2711-5551
 LA Sales Office (USA) +1)714-616-6989

• You can also contact us by e-mail : coilmaster@coilmaster.com

- All specifications are subject to change without notice.
- Update date : 2022.08.10

www.coilmaster.com