

CMI-CMMPP13065LL-SERIES

Features

- ▶ Metal powder molding type for EMC protection.
- ▶ Available tape and reel for auto insertion.
- ▶ Halogen-Free.
- ▶ RoHS compliant.
- ▶ AEC-Q200 qualified

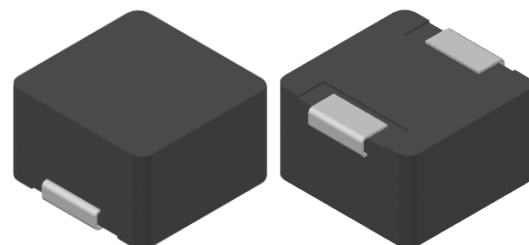

Applications

- ▶ Equipment using for automobiles (ECM, Airbags, Headlights, Electronic Power steering, Motors, ABS, other)

Dimension (Unit:mm)

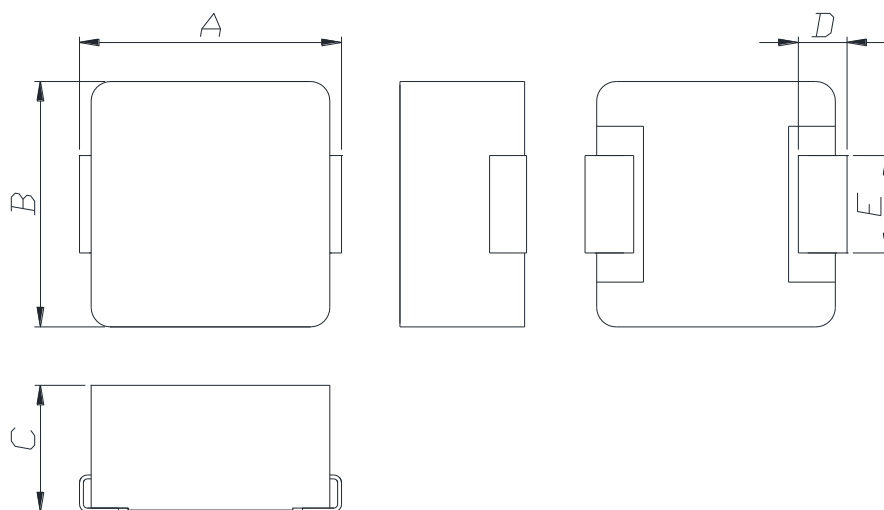

A	B	C	D	E
13.65 ±0.5	12.6 ±0.4	6.5 Max.	2.0 ±0.5	5.0 ±0.2

Land Pattern (Unit:mm)

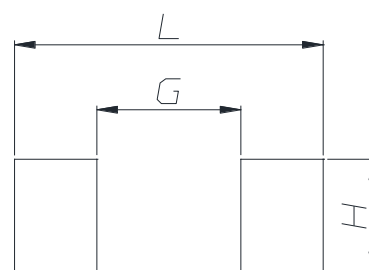

L	G	H
15.0	7.0	5.5

Electrical characteristics

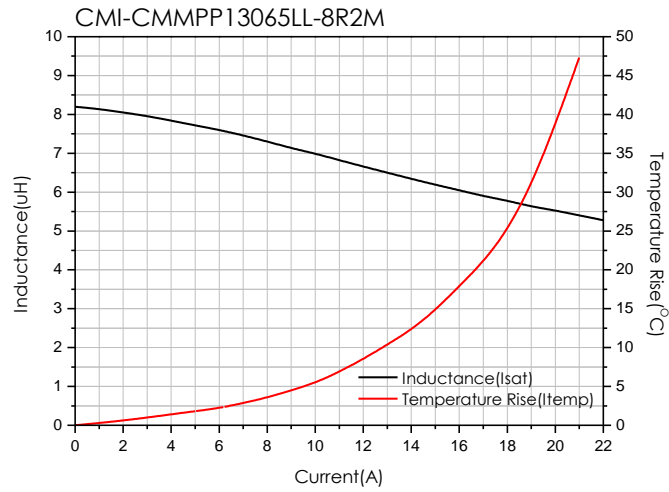
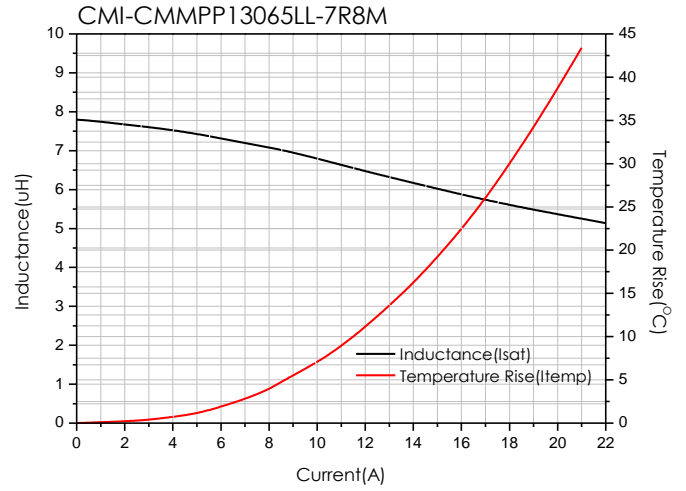
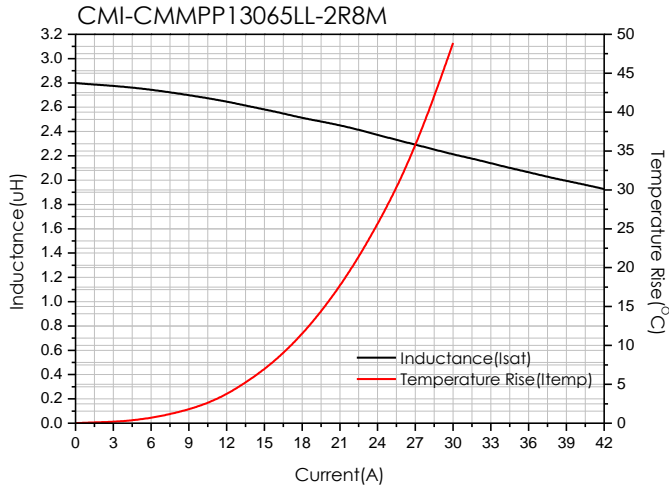

- You can also contact us by e-mail : coilmaster@coilmaster.com
- All specifications are subject to change without notice.
- Update date : 2023.04.04

Packaging

(1) Package quantity : 350(pcs/reel)

(2) Reel Dimensions (unit:mm)

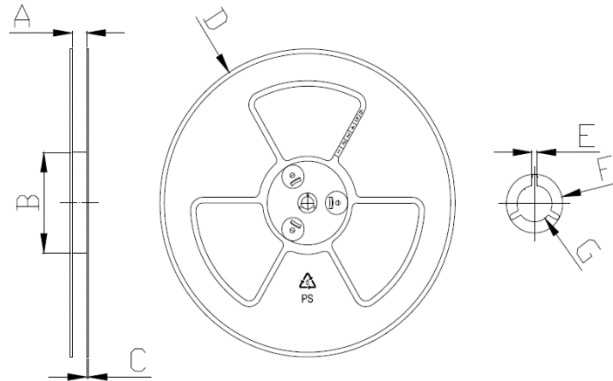

A	B	C	D	E	F	G
24.50	100.0	2.30	330.0	2.30	21.50	13.00
+0.50	+1.00	+0.20	+3.00	+0.30	+0.30	+0.50
-0.50	-1.00	-0.20	-3.00	-0.30	-0.30	-0.20

(3) Tape Dimensions

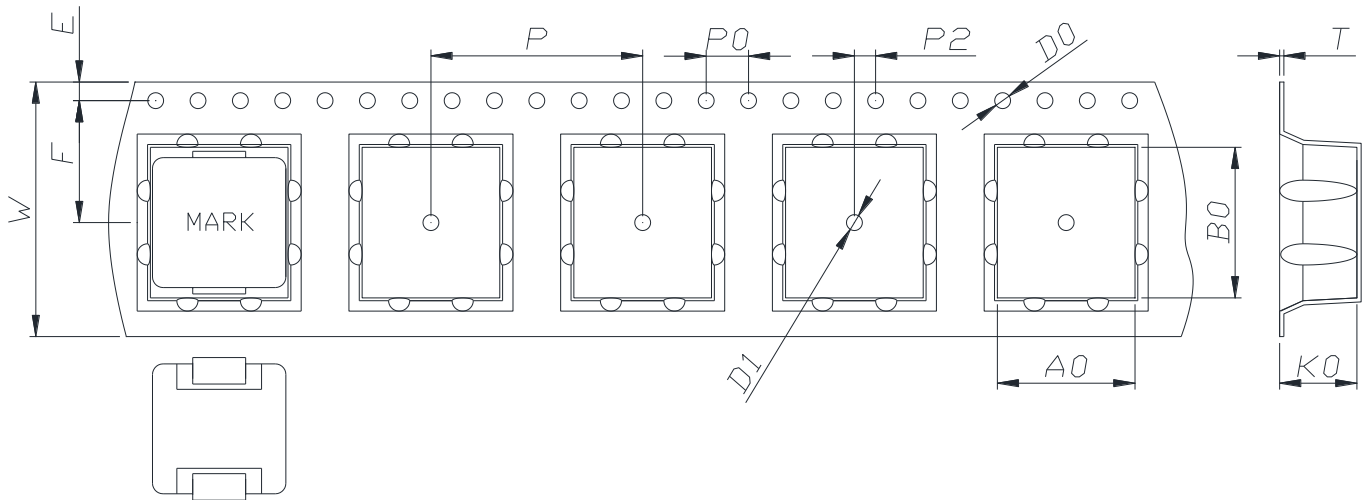

W	A0	B0	K0	E	F	P	P0	P2	D0/D1	T
24.00	13.00	14.20	7.30	1.75	11.50	20.00	4.00	2.00	1.50	0.40
+0.30	+0.10	+0.10	+0.10	+0.10	+0.10	+0.10	+0.10	+0.10	+0.10	+0.05
-0.30	-0.10	-0.10	-0.10	-0.10	-0.10	-0.10	-0.10	-0.10	-0.00	-0.05

Korea Sales Office (KOREA) +82)31-904-1444
 China Sales Office (CHINA) +86)0758-683-1444
 Hungary Sales office (EUROPE) +36)1-404-5832

H.K Sales Office (HONGKONG) +852)2711-5551
 LA Sales Office (USA) +1)714-616-6989

• You can also contact us by e-mail : coilmaster@coilmaster.com

- All specifications are subject to change without notice.
- Update date : 2023.04.04

www.coilmaster.com