

CMI-CMMPP6030LH-N SERIES

Features

- ▶ Metal powder molding type for EMC protection.
- ▶ Available tape and reel for auto insertion.
- ▶ Halogen-Free.
- ▶ RoHS compliant.
- ▶ AEC-Q200 qualified.

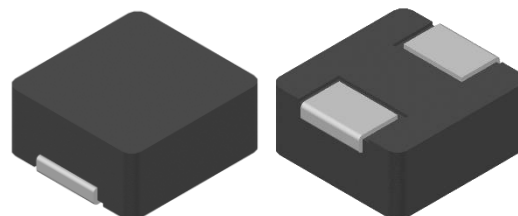

Applications

- ▶ Equipment using for automobiles (ECM, Airbags, Headlights, Electronic Power steering, Motors, ABS, other)

Dimension (Unit:mm)

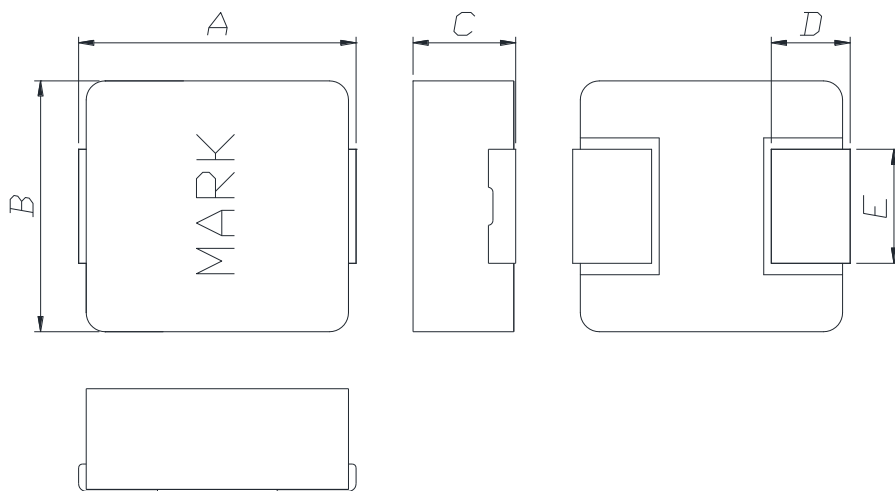

A	B	C	D	E
6.95 ±0.45	6.6 ±0.25	3.0 Max.	1.8 ±0.3	3.0 ±0.3

Land Pattern (Unit:mm)

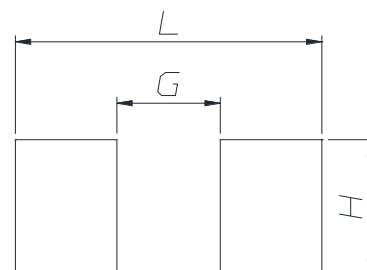

L	G	H
8.0	3.7	3.5

Regulation of part number



- ① CoilMaster's initial
- ② Series Name : Car Metal Molded Pin type Power inductor
- ③ Core Size (unit:mm)
- ④ Material
- ⑤ Typical inductance value (0.1uH)
- ⑥ Inductance tolerance ($\pm 20\%$)
- ⑦ Revision (N)

Specifications

Part Number	Inductance (uH) $\pm 20\%$	DCR(mohm) Max.(Typ.)	Isat(A) Max.(Typ.)	Itemp(A) Max.(Typ.)	Test Frequency (Hz)
CMI-CMMPP6030LH-R10M-N	0.10	1.8(1.4)	57.0(67.0)	22.0(24.0)	1M
CMI-CMMPP6030LH-R15M-N	0.15	2.0(1.6)	45.0(50.0)	21.5(23.5)	1M
CMI-CMMPP6030LH-R22M-N	0.22	2.2(1.8)	42.0(45.0)	20.5(21.5)	1M
CMI-CMMPP6030LH-R33M-N	0.33	3.6(3)	35.0(38.0)	16.8(17.5)	1M
CMI-CMMPP6030LH-R47M-N	0.47	4.8(4)	29.0(32.0)	14.5(15.5)	1M
CMI-CMMPP6030LH-R68M-N	0.68	6.6(5.5)	26.0(29.0)	13.5(14.5)	1M
CMI-CMMPP6030LH-1R0M-N	1.0	10.8(9)	20.0(23.0)	9.0(10.0)	1M
CMI-CMMPP6030LH-1R5M-N	1.5	15(12.5)	19.0(21.0)	8.5(9.0)	1M
CMI-CMMPP6030LH-2R2M-N	2.2	15.6(13)	13.5(15.0)	7.5(8.0)	1M
CMI-CMMPP6030LH-3R3M-N	3.3	29(24)	12.0(13.0)	6.3(6.7)	1M
CMI-CMMPP6030LH-4R7M-N	4.7	36(30)	9.5(10.5)	6.0(6.5)	1M
CMI-CMMPP6030LH-5R6M-N	5.6	60(50)	8.5(9.5)	5.8(6.3)	1M
CMI-CMMPP6030LH-6R8M-N	6.8	62.4(52)	8.0(9.0)	5.6(6.2)	1M
CMI-CMMPP6030LH-8R2M-N	8.2	64(54)	6.5(7.2)	4.1(4.4)	1M
CMI-CMMPP6030LH-100M-N	10	76(64)	6.0(7.0)	4.0(4.1)	1M
CMI-CMMPP6030LH-150M-N	15	114(95)	4.5(5.0)	3.2(3.5)	1M

• You can also contact us by e-mail : coilmaster@coilmaster.com

- All specifications are subject to change without notice.
- Update date : 2023.01.31

Part Number	Inductance (uH) $\pm 20\%$	DCR(mohm) Max.(Typ.)	Isat(A) Max.(Typ.)	Itemp(A) Max.(Typ.)	Test Frequency (Hz)
CMI-CMMPP6030LH-220M-N	22	150(125)	3.8(4.3)	2.9(3.2)	1M
CMI-CMMPP6030LH-330M-N	33	240(200)	3.2(3.7)	2.5(2.7)	1M

- Isat: When based on the inductance change rate (Approximately 30% below in the initial value)
- Itemp: When based on the temperature increase (Temperature increase of approximately 40°C by self heating)
- Operating Temperature Range (including self temperature) : -40°C ~ +165 °C

Note 1 : Circuit design, component placement, PCB trace size and thickness, airflow and other cooling. Provision all affect the part Temperature. Part temperature should be verified in the end application.

Electrical characteristics

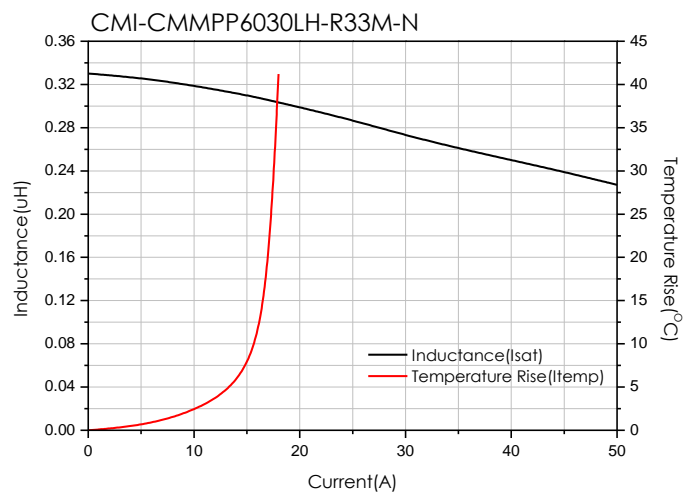
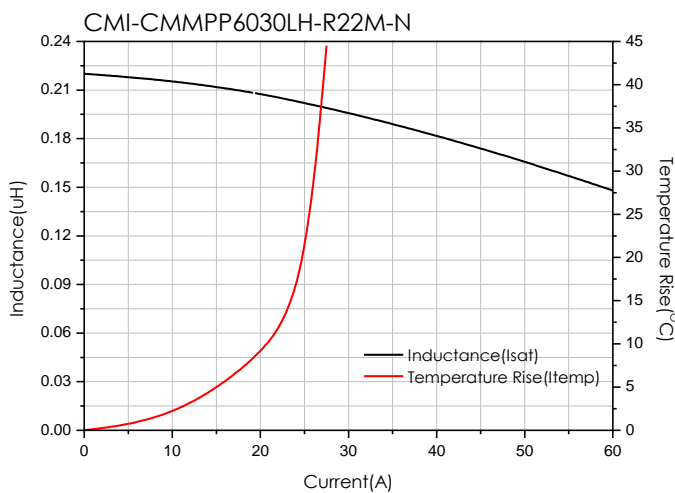
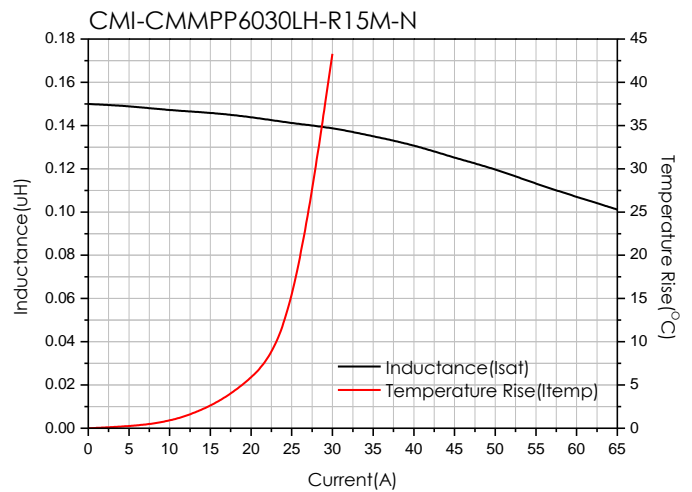
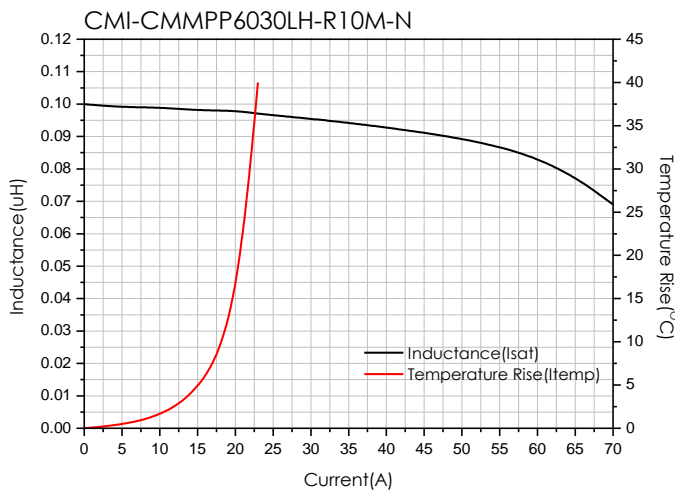

- You can also contact us by e-mail : coilmaster@coilmaster.com
- All specifications are subject to change without notice.
- Update date : 2023.01.31

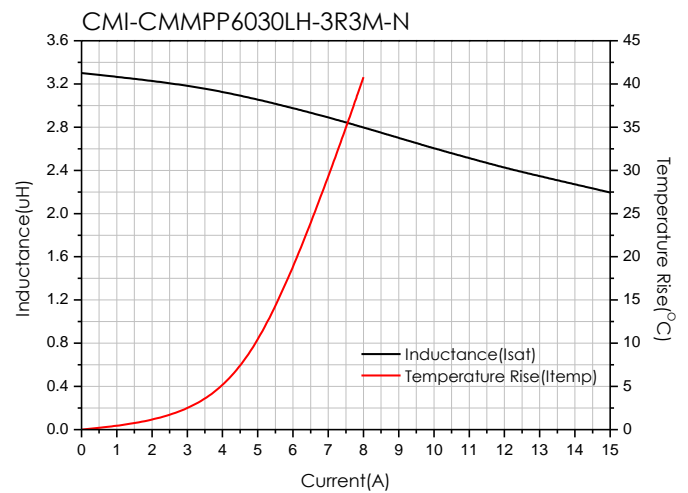
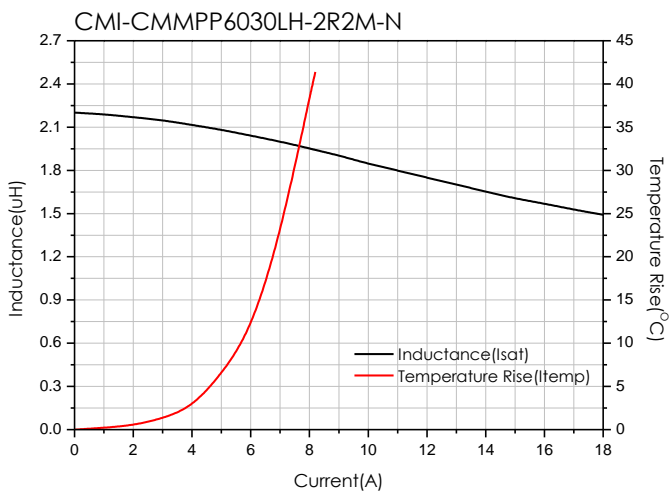
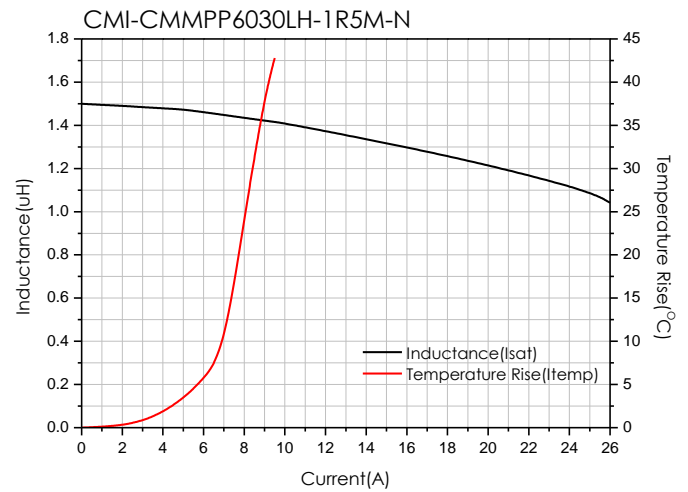
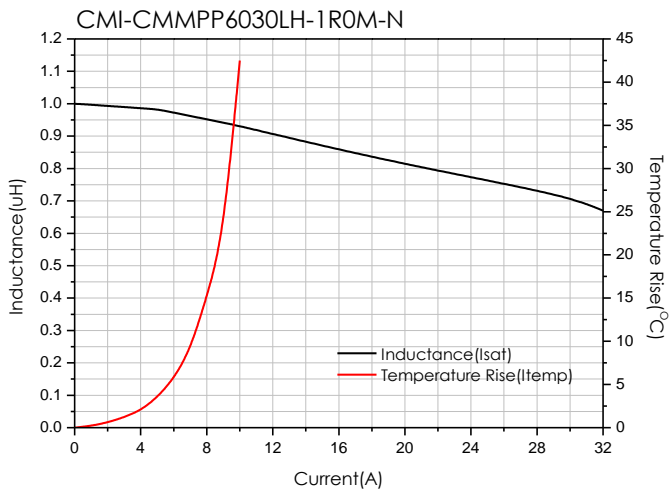
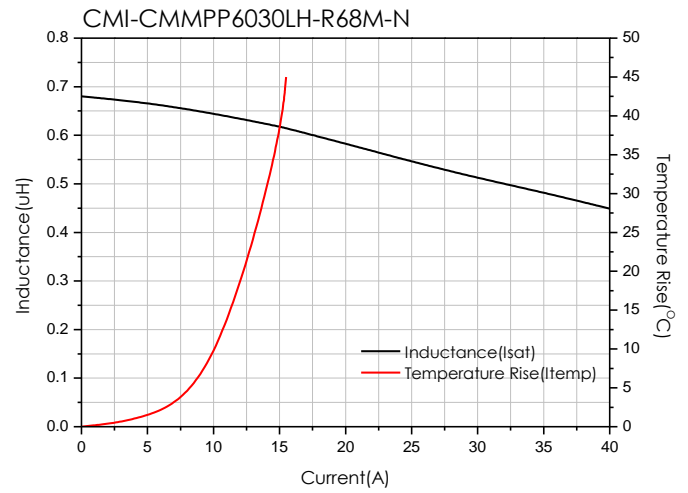
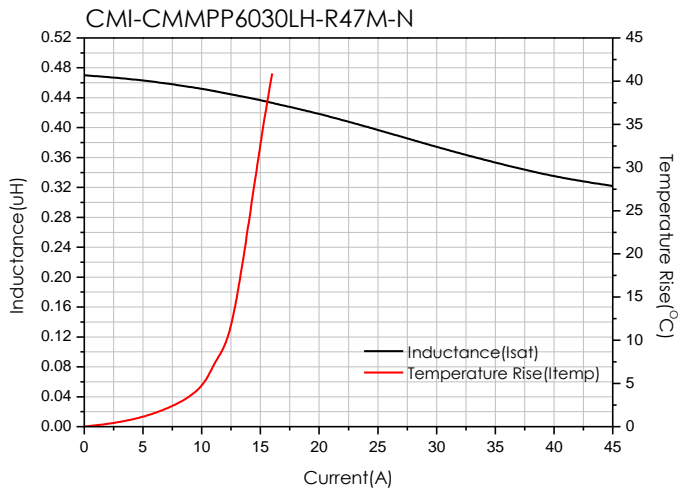

- You can also contact us by e-mail : coilmaster@coilmaster.com
- All specifications are subject to change without notice.
- Update date : 2023.01.31

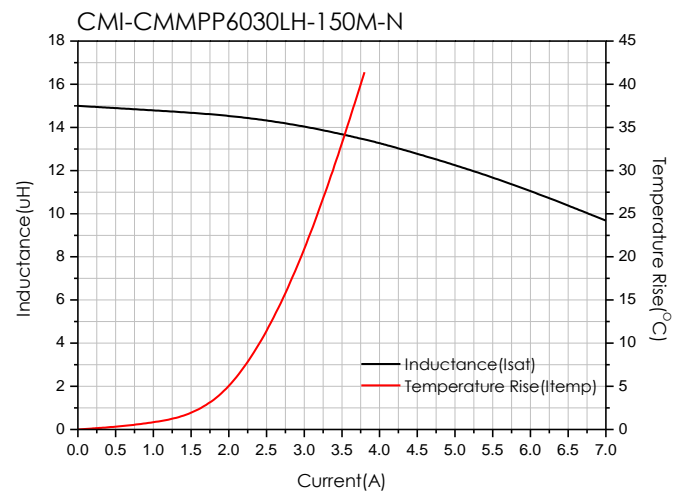
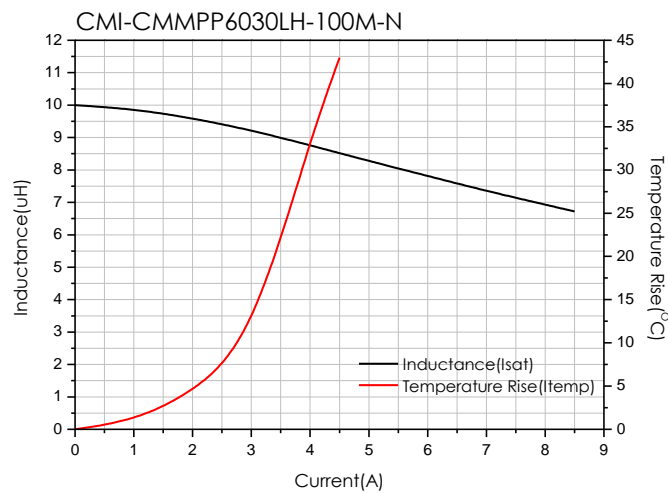
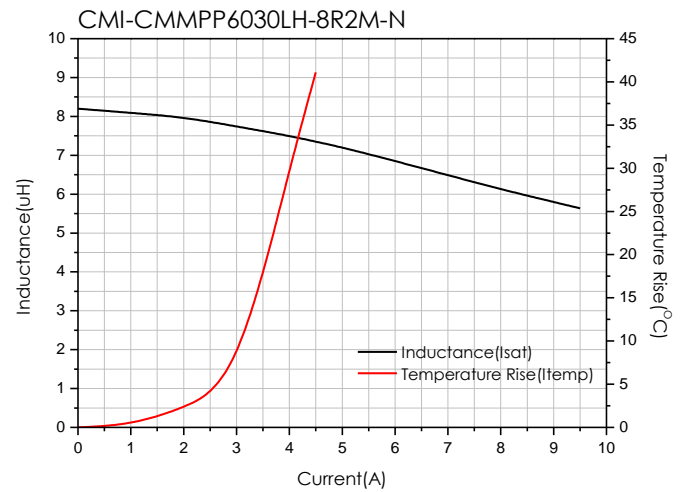
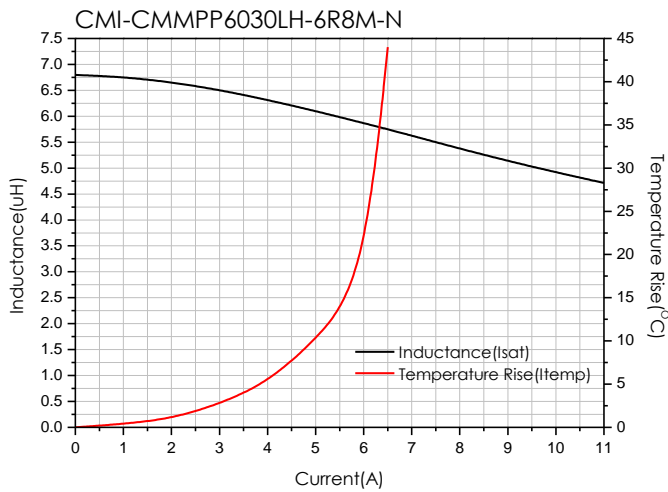
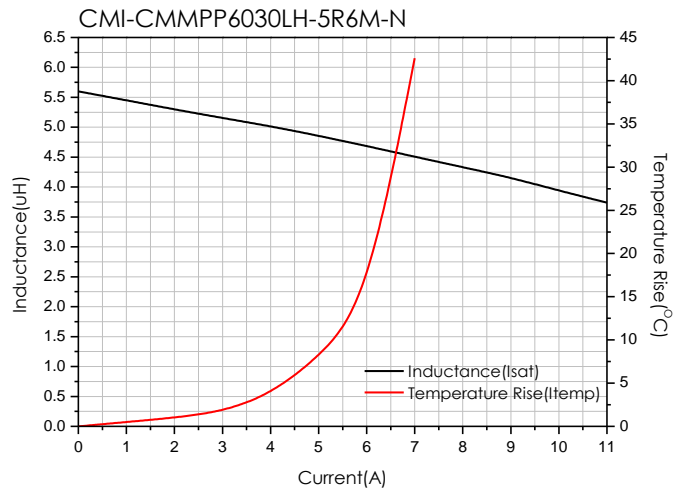
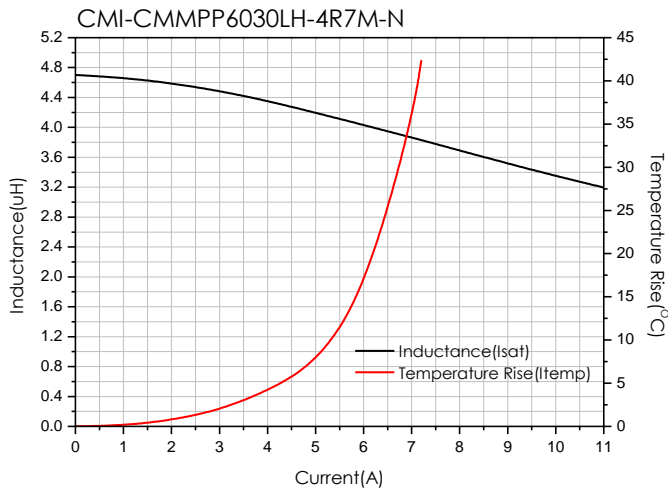

- You can also contact us by e-mail : coilmaster@coilmaster.com
- All specifications are subject to change without notice.
- Update date : 2023.01.31

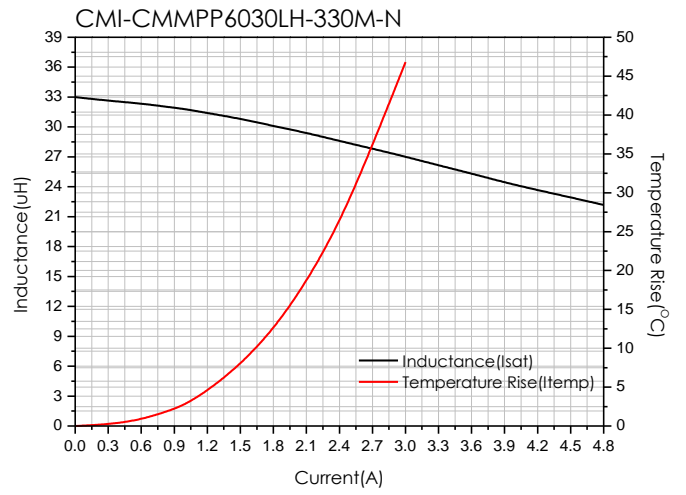
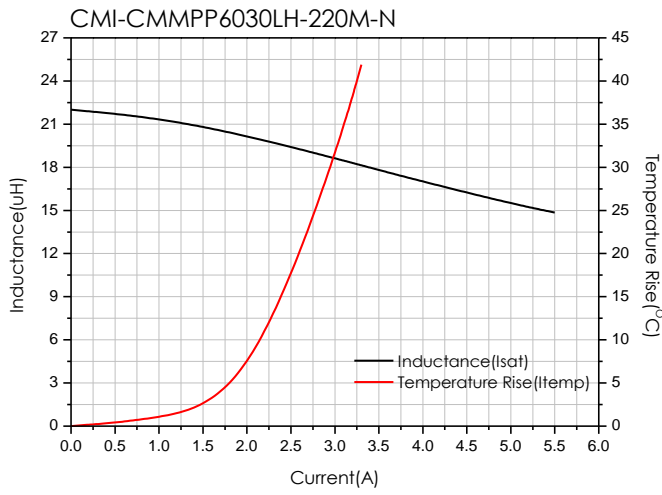

- You can also contact us by e-mail : coilmaster@coilmaster.com
- All specifications are subject to change without notice.
- Update date : 2023.01.31

Packaging

(1) Package quantity : 1,000 (pcs/reel)

(2) Reel Dimensions (unit:mm)

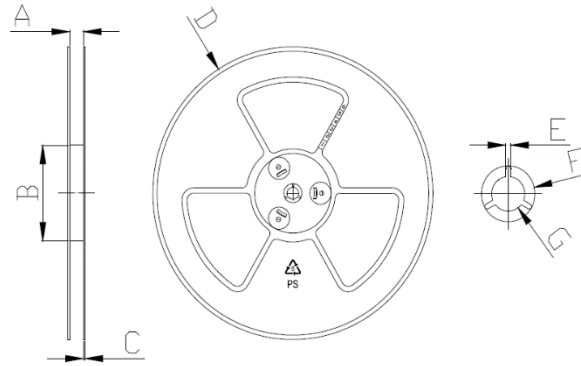

A	B	C	D	E	F	G
16.50	100.0	2.00	330.0	2.30	21.50	13.00
+0.50	+1.00	+0.10	+3.00	+0.30	+0.30	+0.50
-0.50	-1.00	-0.10	-3.00	-0.30	-0.30	-0.20

(3) Tape Dimensions

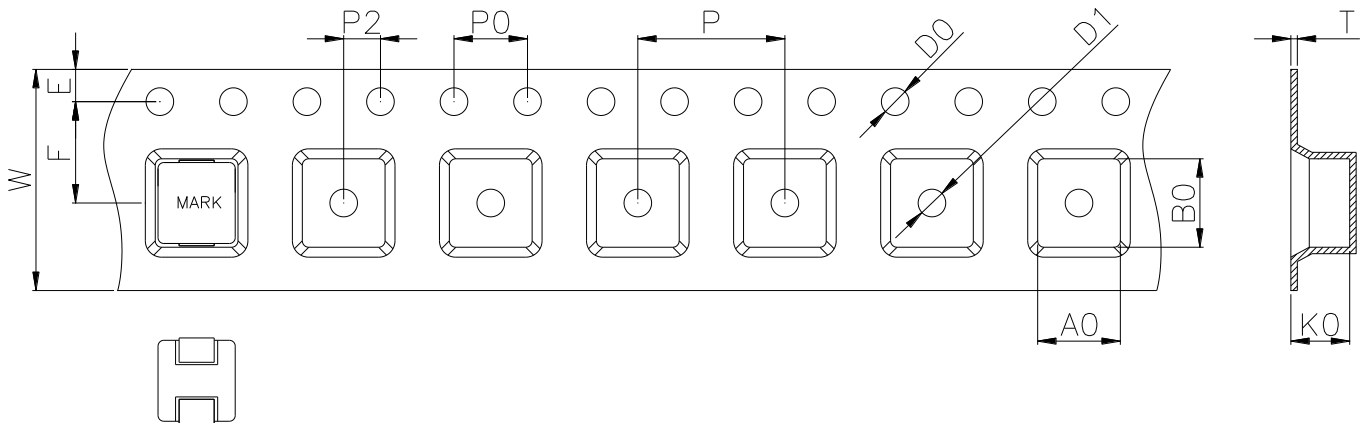

W	A0	B0	K0	E	F	P	P0	P2	D0/D1	T
16.00	7.00	7.50	3.20	1.75	7.50	12.00	4.00	2.00	1.50	0.35
+0.30	+0.10	+0.10	+0.10	+0.10	+0.10	+0.10	+0.10	+0.10	+0.10	+0.05
-0.10	-0.10	-0.00	-0.10	-0.10	-0.10	-0.10	-0.10	-0.10	-0.00	-0.05

Korea Sales Office (KOREA) +82)31-904-1444
 China Sales Office (CHINA) +86)0758-683-1444
 Hungary Sales office (EUROPE) +36)1-404-5832

H.K Sales Office (HONGKONG) +852)2711-5551
 LA Sales Office (USA) +1)714-616-6989

• You can also contact us by e-mail : coilmaster@coilmaster.com

- All specifications are subject to change without notice.
- Update date : 2023.01.31

www.coilmaster.com