

CMI-CMMPP6040HL-N SERIES

Features

- ▶ Metal powder molding type for EMC protection.
- ▶ Available tape and reel for auto insertion.
- ▶ Halogen-Free.
- ▶ RoHS compliant.
- ▶ AEC-Q200 qualified.

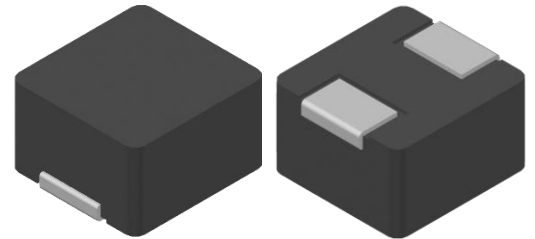

Applications

- ▶ Equipment using for automobiles (ECM, Airbags, Headlights, Electronic Power steering, Motors, ABS, other)

Dimension (Unit:mm)

Land Pattern (Unit:mm)

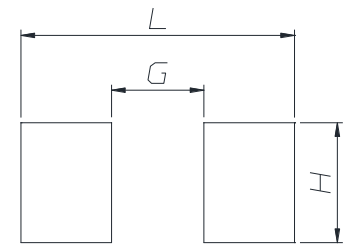
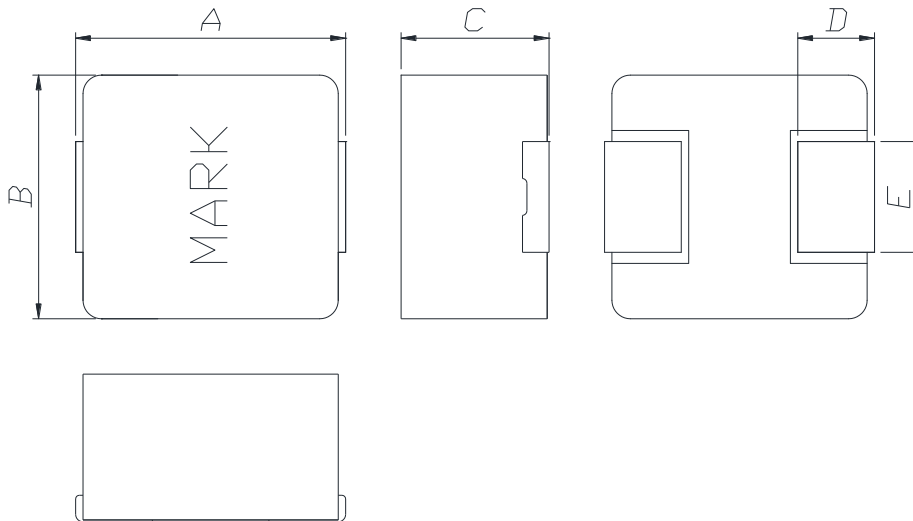

A	B	C	D	E
6.95 ±0.45	6.6 ±0.25	4.0 Max.	1.8 ±0.3	3.0 ±0.3

L	G	H
8.0	3.7	3.5

Regulation of part number

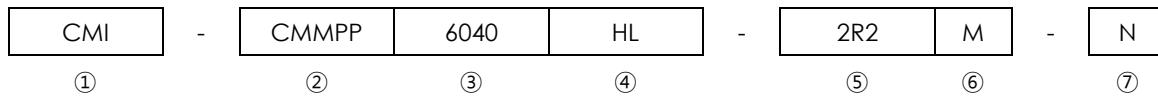

- ① CoilMaster's initial
- ② Series Name : Car Magic Material Pin type Power inductor
- ③ Core Size (unit:mm)
- ④ Material
- ⑤ Typical inductance value (2.2uH)
- ⑥ Inductance tolerance ($\pm 20\%$)
- ⑦ Revision (N)

Specifications

Part Number	Inductance (uH) $\pm 20\%$	DCR(mohm) Max.(Typ.)	Isat(A) Max.(Typ.)	Itemp(A) Max.(Typ.)	Test Frequency (Hz)
CMI-CMMPP6040HL-2R2M-N	2.2	14.4(12)	12.0(13.5)	8.0(8.5)	1M
CMI-CMMPP6040HL-4R7M-N	4.7	22.2(18.5)	8.5(10.0)	7.0(7.5)	1M
CMI-CMMPP6040HL-6R8M-N	6.8	48(40)	6.0(7.5)	5.5(6.0)	1M
CMI-CMMPP6040HL-100M-N	10	60(50)	5.3(5.8)	5.0(5.5)	1M
CMI-CMMPP6040HL-150M-N	15	90(75)	4.0(4.5)	3.7(4.2)	1M
CMI-CMMPP6040HL-220M-N	22	108(90)	3.5(4.0)	3.5(4.0)	1M
CMI-CMMPP6040HL-330M-N	33	156(130)	2.8(3.3)	2.8(3.3)	1M

- Isat: When based on the inductance change rate (Approximately 30% below in the initial value)
- Itemp: When based on the temperature increase (Temperature increase of approximately 40°C by self heating)
- Operating Temperature Range (including self temperature) : -40°C ~ +165 °c

Note 1 : Circuit design, component placement, PCB trace size and thickness, airflow and other cooling. Provision all affect the part Temperature. Part temperature should be verified in the end application.

- **You can also contact us by e-mail : coilmaster@coilmaster.com**
- All specifications are subject to change without notice.
- Update date : 2021.10.12

Electrical characteristics

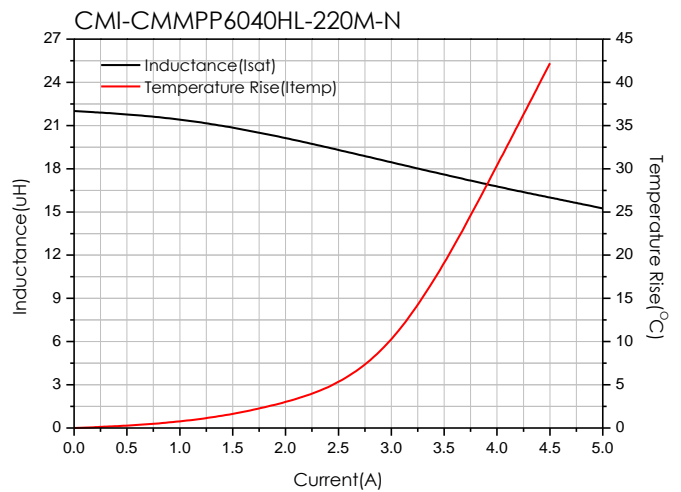
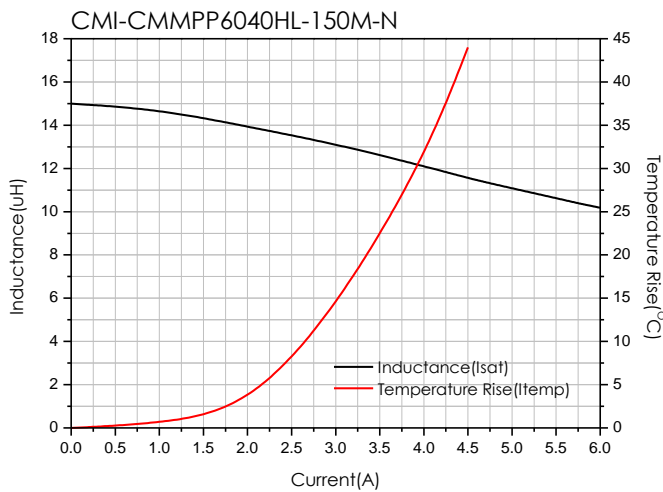
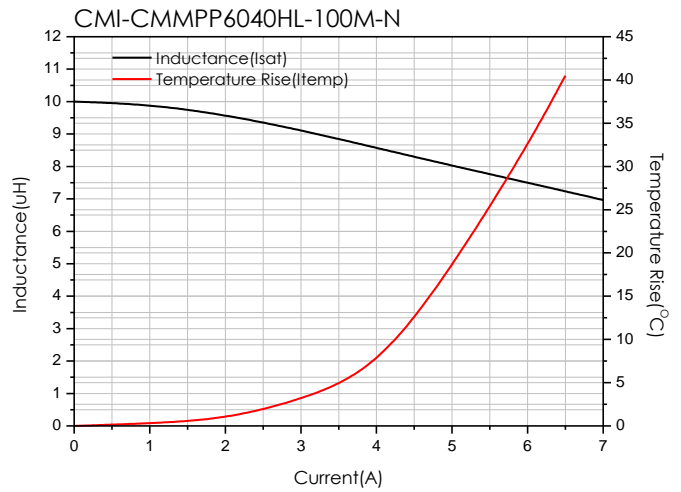
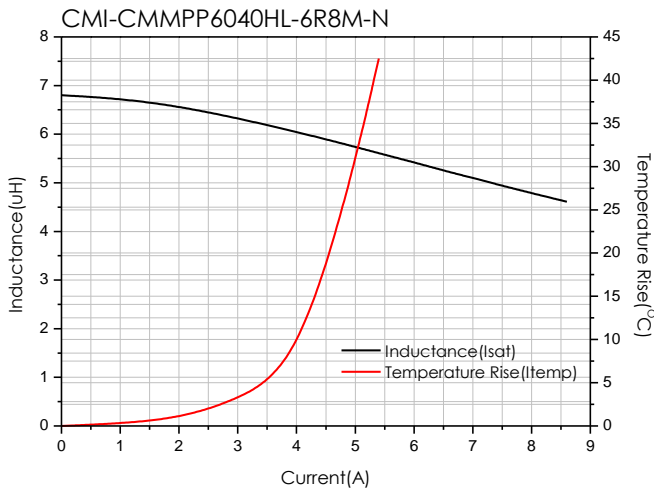
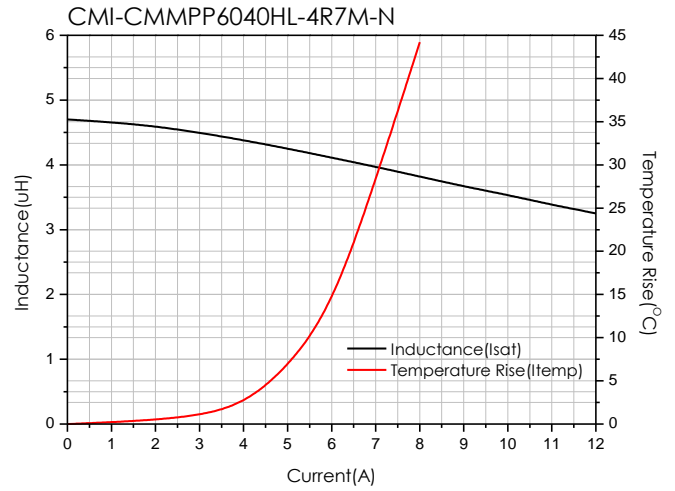
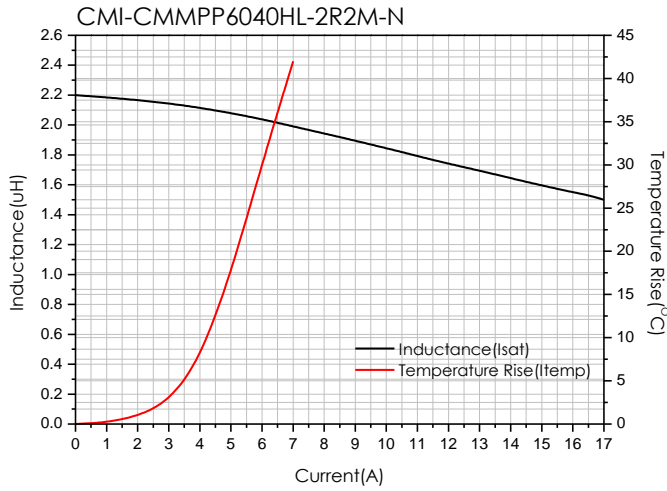

- You can also contact us by e-mail : coilmaster@coilmaster.com
- All specifications are subject to change without notice.
- Update date : 2021.10.12

CMI-CMMPP6040HL-330M-N

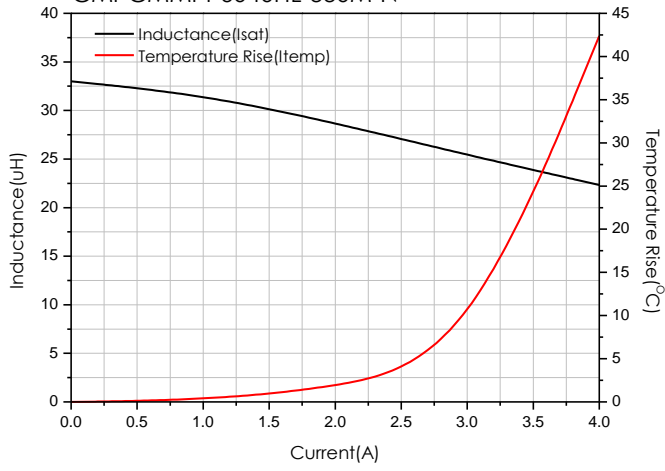

- You can also contact us by e-mail : coilmaster@coilmaster.com
- All specifications are subject to change without notice.
- Update date : 2021.10.12

Packaging

(1) Package quantity : 1,000 (pcs/reel)

(2) Reel Dimensions (unit:mm)

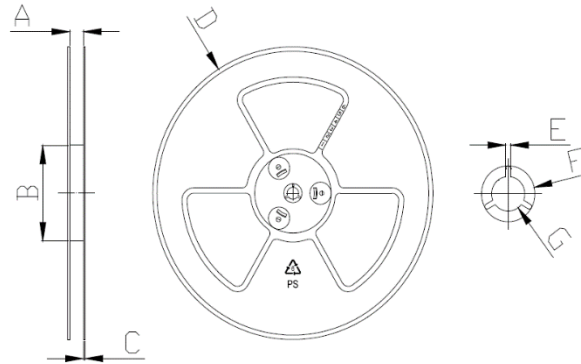

A	B	C	D	E	F	G
16.50	100.0	2.00	330.0	2.30	21.50	13.00
+0.50	+1.00	+0.10	+3.00	+0.30	+0.30	+0.50
-0.50	-1.00	-0.10	-3.00	-0.30	-0.30	-0.20

(3) Tape Dimensions

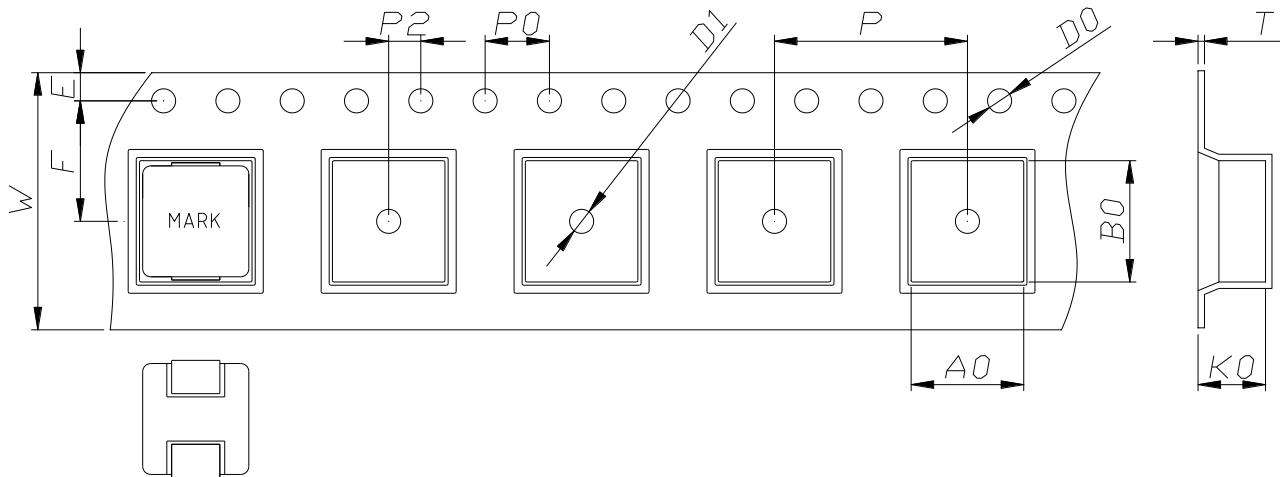

W	A0	B0	K0	E	F	P	P0	P2	D0/D1	T
16.00	7.00	7.55	4.20	1.75	7.50	12.00	4.00	2.00	1.50	0.40
+0.30	+0.10	+0.10	+0.10	+0.10	+0.10	+0.10	+0.10	+0.10	+0.10	+0.05
-0.10	-0.10	-0.10	-0.10	-0.10	-0.10	-0.10	-0.10	-0.10	-0.00	-0.05

Korea Sales Office (KOREA) +82)31-904-1444
 China Sales Office (CHINA) +86)0758-683-1444
 Hungary Sales office (EUROPE) +36)1-404-5832

H.K Sales Office (HONGKONG) +852)2711-5551
 LA Sales Office (USA) +1)714-616-6989

• You can also contact us by e-mail : coilmaster@coilmaster.com

- All specifications are subject to change without notice.
- Update date : 2021.10.12

www.coilmaster.com