

CMI-CMMPP8050HL-SERIES

Features

- ▶ Metal powder molding type for EMC protection.
- ▶ Available tape and reel for auto insertion.
- ▶ Halogen-Free
- ▶ RoHS compliant.
- ▶ AEC-Q200 qualified.

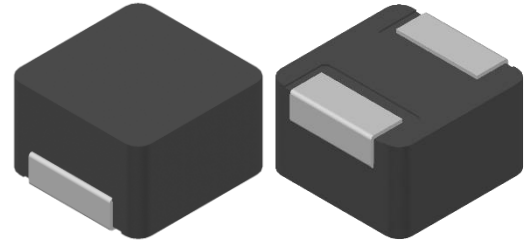

Applications

- ▶ Equipment using for automobiles (ECM, Airbags, Headlights, Electronic Power steering, Motors, ABS, other)

Dimension (Unit:mm)

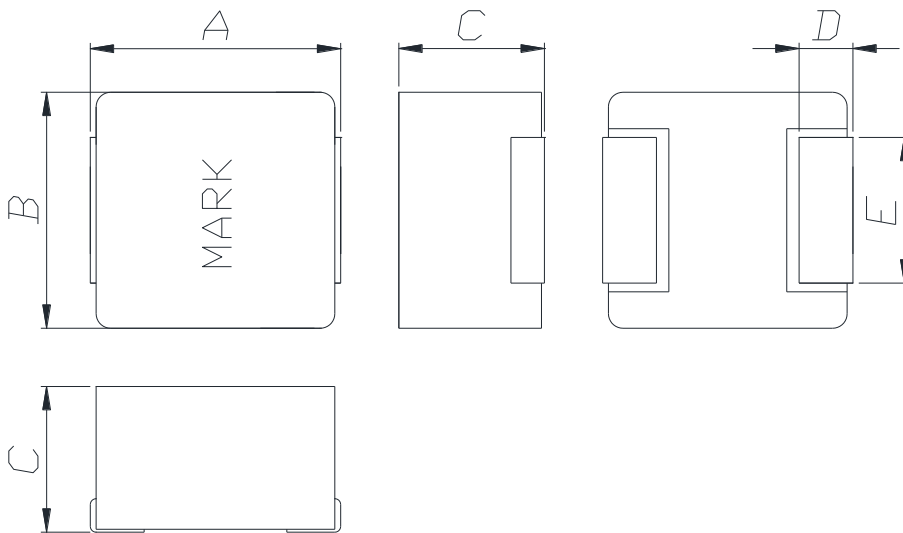

A	B	C	D	E
8.6 ±0.35	8.1 ±0.25	5.0 Max.	1.85 ±0.3	5.0 ±0.2

Land Pattern (Unit:mm)

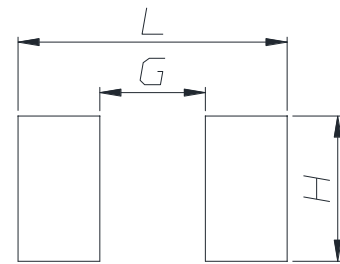

L	G	H
10.2	4.0	5.5

Regulation of part number

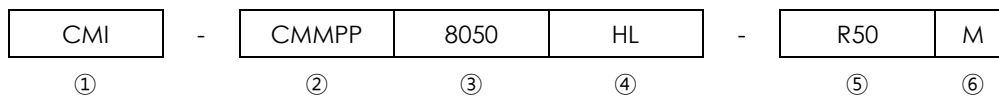

- ① CoilMaster's initial
- ② Series Name : Car Metal Molded Pin type Power inductor
- ③ Core Size (unit:mm)
- ④ Material
- ⑤ Typical inductance value (0.5 uH)
- ⑥ Inductance tolerance (±20%)

Specifications

Part Number	Inductance (uH) ±20%	DCR(mohm) Max.(Typ.)	Isat(A) Max.(Typ.)	Itemp(A) Max.(Typ.)	Test Frequency (Hz)
CMI-CMMPP8050HL-R50M	0.50	3.0(2.5)	33.0(38.0)	23.0(25.0)	1M
CMI-CMMPP8050HL-R82M	0.82	5.4(4.5)	27.0(32.0)	18.5(19.5)	1M
CMI-CMMPP8050HL-1R0M	1.0	6.0(5.0)	25.0(27.0)	14.5(15.5)	1M
CMI-CMMPP8050HL-1R5M	1.5	9.0(7.5)	20.0(22.0)	12.5(13.5)	1M
CMI-CMMPP8050HL-2R2M	2.2	12(10)	18.0(20.0)	11.5(12.5)	1M
CMI-CMMPP8050HL-3R3M	3.3	18(15)	14.0(16.0)	10.5(11.5)	1M
CMI-CMMPP8050HL-4R7M	4.7	24(20)	13.5(14.5)	8.0(8.5)	1M
CMI-CMMPP8050HL-6R8M	6.8	36(30)	10.0(11.0)	6.0(6.5)	1M
CMI-CMMPP8050HL-100M	10	60(50)	7.5(8.5)	4.5(5.0)	1M
CMI-CMMPP8050HL-150M	15	78(65)	5.0(5.5)	4.0(4.2)	1M
CMI-CMMPP8050HL-220M	22	114(95)	4.5(5.0)	3.8(4.0)	1M
CMI-CMMPP8050HL-270M	27	126(105)	4.4(4.9)	3.5(3.7)	1M
CMI-CMMPP8050HL-330M	33	144(120)	4.3(4.8)	3.3(3.5)	1M
CMI-CMMPP8050HL-470M	47	204(170)	4.0(4.5)	3.1(3.3)	1M

- Isat: When based on the inductance change rate (Approximately 30% below in the initial value)
- Itemp: When based on the temperature increase (Temperature increase of approximately 40°C by self heating)
- Operating Temperature Range (including self temperature) : -40°C ~ +165 °c

Note 1 : Circuit design, component placement, PCB trace size and thickness, airflow and other cooling. Provision all affect the part Temperature. Part temperature should be verified in the end application.

▪ **You can also contact us by e-mail : coilmaster@coilmaster.com**

- All specifications are subject to change without notice.
- Update date : 2023.07.25

www.coilmaster.com

Electrical characteristics

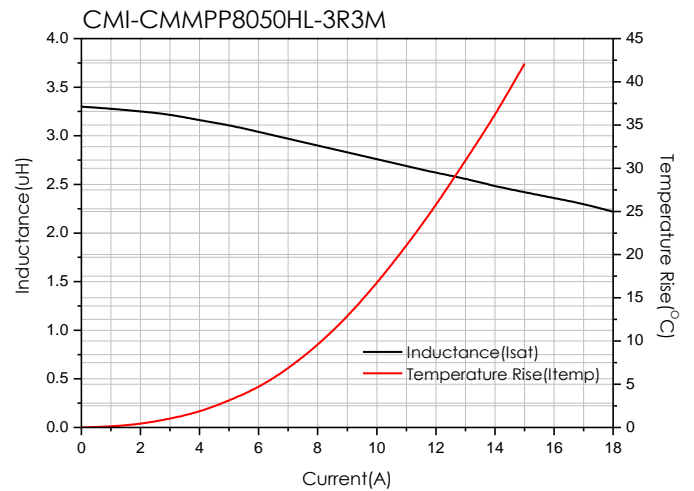
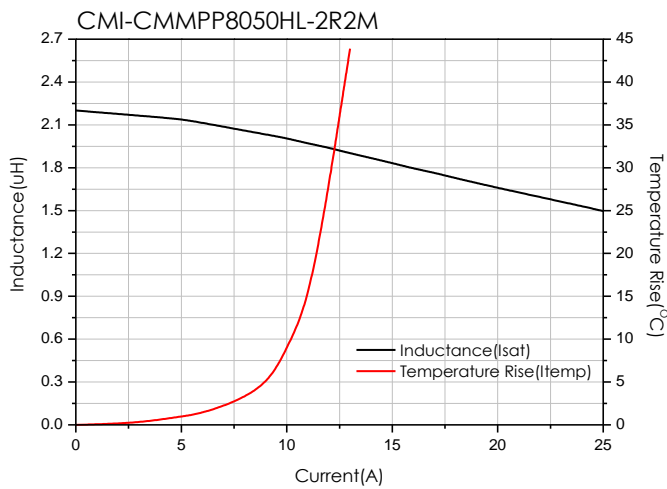
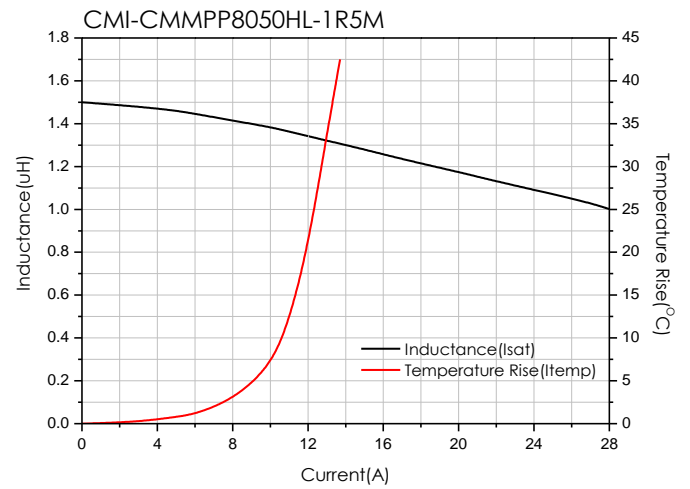
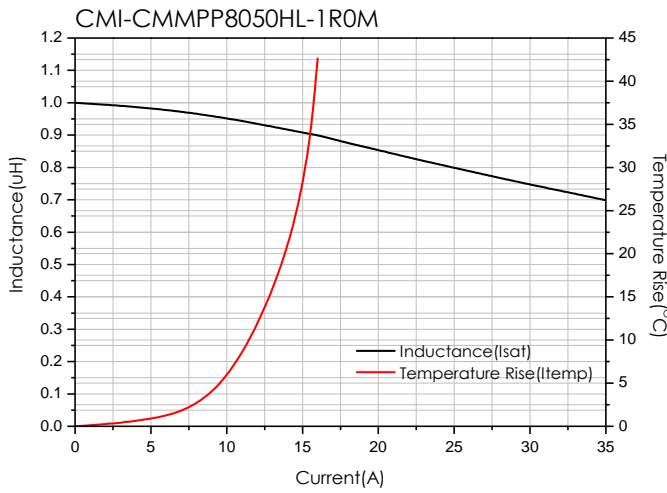
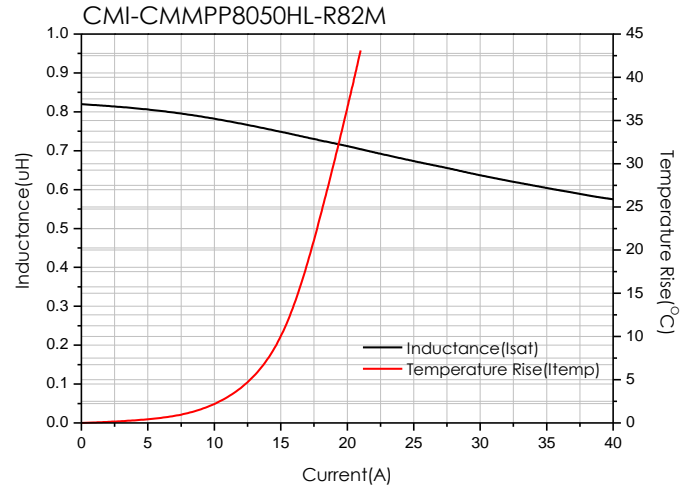
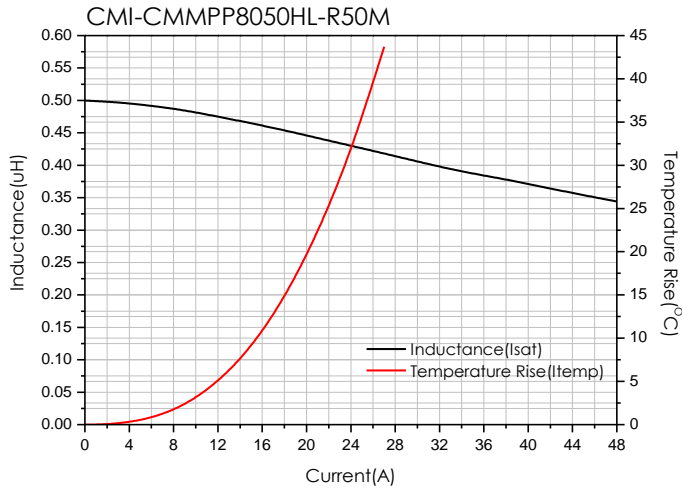

- You can also contact us by e-mail : coilmaster@coilmaster.com
- All specifications are subject to change without notice.
- Update date : 2023.07.25

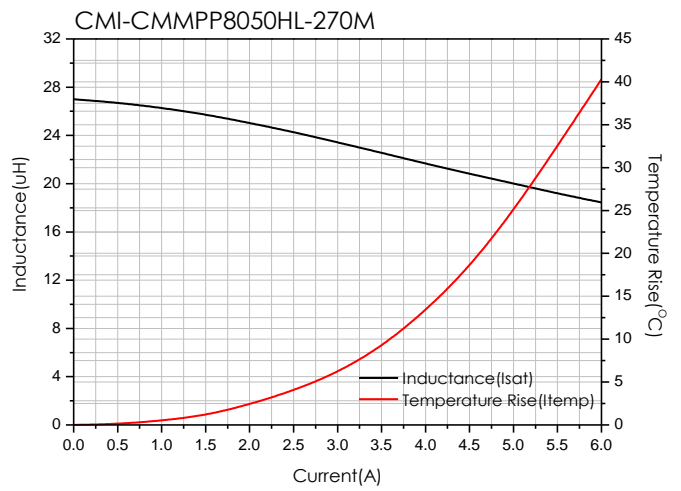
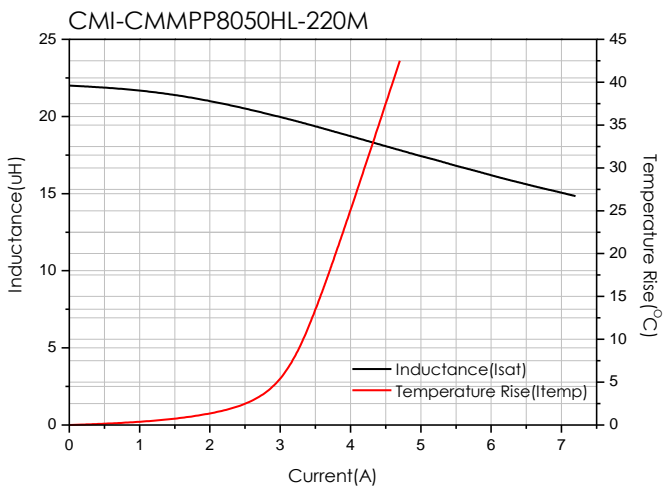
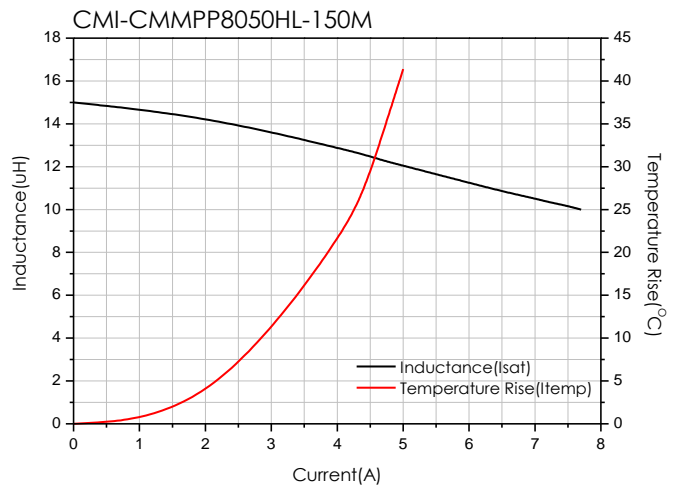
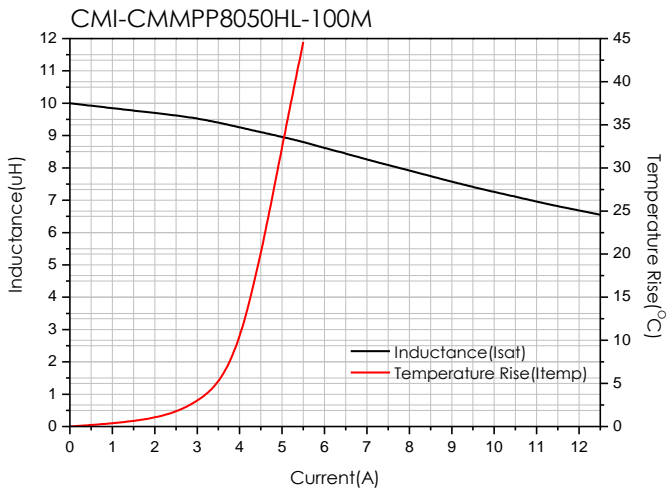
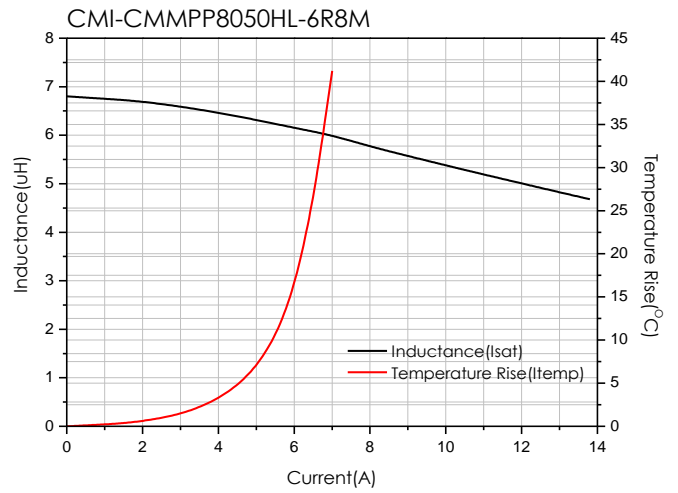
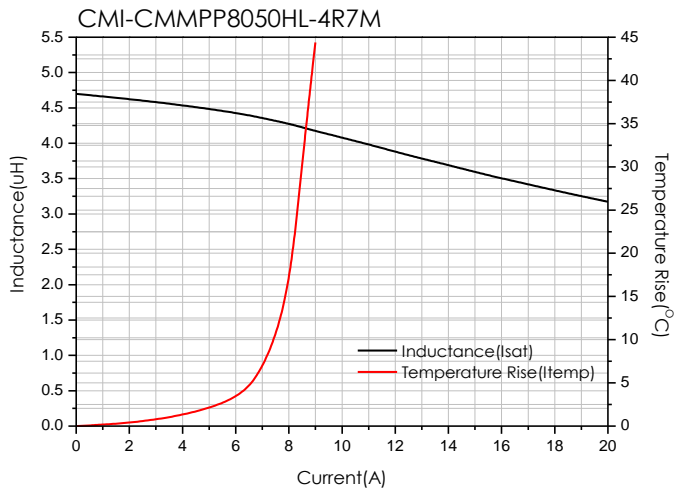

- You can also contact us by e-mail : coilmaster@coilmaster.com
- All specifications are subject to change without notice.
- Update date : 2023.07.25

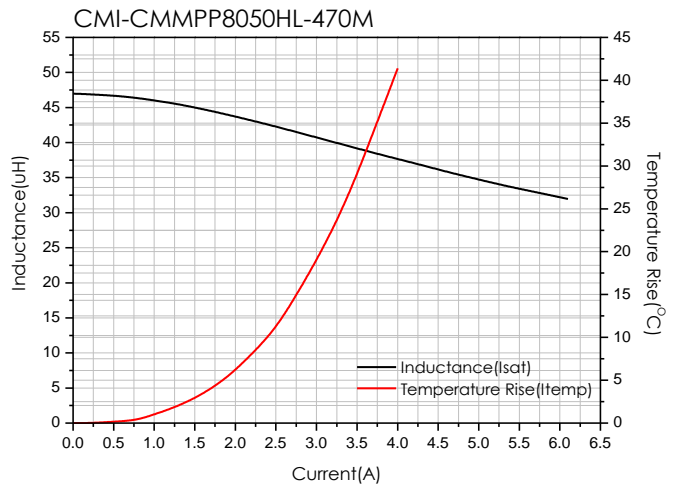
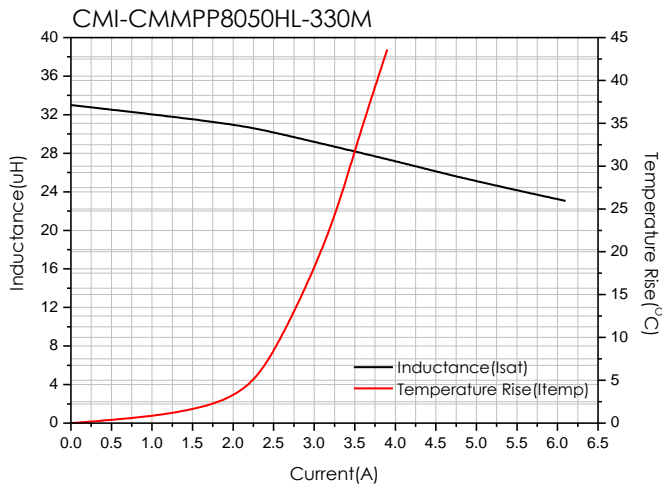

- You can also contact us by e-mail : coilmaster@coilmaster.com
- All specifications are subject to change without notice.
- Update date : 2023.07.25

Packaging

(1) Package quantity : 700 (pcs/reel)

(2) Reel Dimensions (unit:mm)

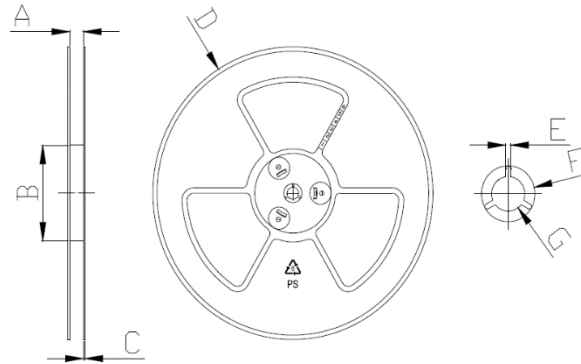

A	B	C	D	E	F	G
24.50	100.0	2.30	330.0	2.30	21.50	13.00
+0.50	+1.00	+0.20	+3.00	+0.30	+0.30	+0.50
-0.50	-1.00	-0.20	-3.00	-0.30	-0.30	-0.20

(3) Tape Dimensions

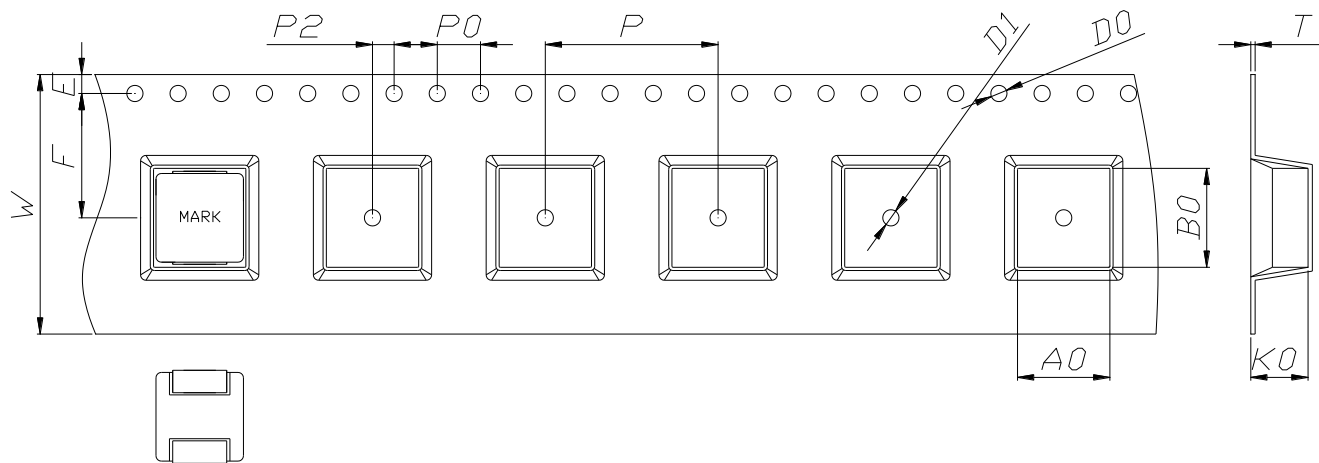

W	A0	B0	K0	E	F	P	P0	P2	D0/D1	T
24.00	8.55	9.15	5.30	1.75	11.50	16.00	4.00	2.00	1.50	0.40
+0.30	+0.10	+0.10	+0.10	+0.10	+0.10	+0.10	+0.10	+0.10	+0.10	+0.05
-0.10	-0.10	-0.10	-0.10	-0.10	-0.10	-0.10	-0.10	-0.10	-0.00	-0.05

Korea Sales Office (KOREA) +82)31-904-1444
 China Sales Office (CHINA) +86)0758-683-1444
 Hungary Sales office (EUROPE) +36)1-404-5832

H.K Sales Office (HONGKONG) +852)2711-5551
 LA Sales Office (USA) +1)714-616-6989

• You can also contact us by e-mail : coilmaster@coilmaster.com

- All specifications are subject to change without notice.
- Update date : 2023.07.25

www.coilmaster.com