

# CMI-CRMCI1608-SERIES

### Features

- ▶ Halogen-Free / RoHS compliant.
- ▶ Support operating frequency up to 10GHz.
- ▶ Provide high quality factor.
- ▶ Monolithic structure for high reliability.
- ▶ Excellent solderability and high heat resistance for either flow or reflow soldering.



### Applications

- ▶ RF circuit and module.
- ▶ Digital communication equipment
- ▶ Various electronic equipment.
- ▶ Various automotive electronics

Dimension (Unit:mm)

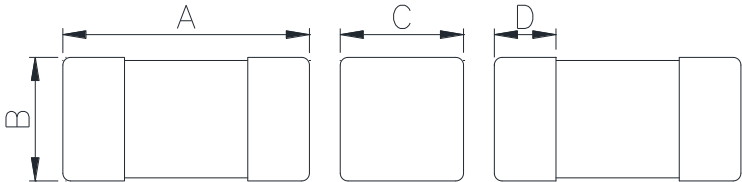

Land Pattern (Unit:mm)

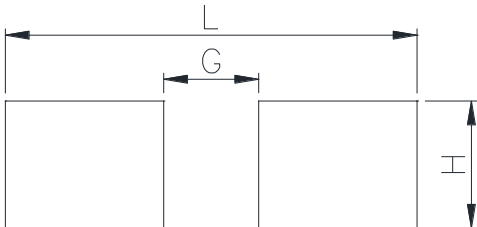

A	B	C	D	L	G	H
1.6±0.15	0.8±0.15	0.8±0.15	0.2~0.6	2.6	0.6	0.8

▪ You can also contact us by e-mail : [coilmaster@coilmaster.com](mailto:coilmaster@coilmaster.com)  
 ▪ All specifications are subject to change without notice.  
 ▪ Update date : 2023.05.10

## Regulation of part number

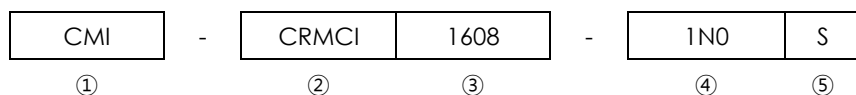

- ① CoilMaster's initial
- ② Product Series Name
- ③ Core Size (unit:mm)
- ④ Inductance Value (1N0 : 1.0 nH)
- ⑤ Inductance Tolerance (S :  $\pm 0.3nH$ , G :  $\pm 2\%$ , J :  $\pm 5\%$ , K :  $\pm 10\%$ , M :  $\pm 20\%$ )

## Specifications

Part Number	Inductance (nH) S: $\pm 0.3$ , J: $\pm 5\%$	Q Min.	Test Frequency (MHz)	SRF (GHz) Min.	DC Resistance (ohm) Max.	Rated Current (mA) Max.
CMI-CRMCI1608-1N0S	1.0	8	100	10.0	0.05	300
CMI-CRMCI1608-1N2S	1.2	8	100	10.0	0.05	300
CMI-CRMCI1608-1N5S	1.5	8	100	6.0	0.10	300
CMI-CRMCI1608-1N8S	1.8	8	100	6.0	0.10	300
CMI-CRMCI1608-2N2S	2.2	8	100	6.0	0.10	300
CMI-CRMCI1608-2N7S	2.7	10	100	6.0	0.10	300
CMI-CRMCI1608-3N3S	3.3	10	100	6.0	0.12	300
CMI-CRMCI1608-3N9S	3.9	10	100	6.0	0.14	300
CMI-CRMCI1608-4N7S	4.7	10	100	4.0	0.16	300
CMI-CRMCI1608-5N6S	5.6	10	100	4.0	0.18	300
CMI-CRMCI1608-6N8S	6.8	10	100	4.0	0.22	300
CMI-CRMCI1608-8N2S	8.2	10	100	3.5	0.24	300
CMI-CRMCI1608-10NJ	10	12	100	3.4	0.26	300
CMI-CRMCI1608-12NJ	12	12	100	2.6	0.28	300
CMI-CRMCI1608-15NJ	15	12	100	2.3	0.32	300
CMI-CRMCI1608-18NJ	18	12	100	2.0	0.35	300
CMI-CRMCI1608-22NJ	22	12	100	1.6	0.40	300
CMI-CRMCI1608-27NJ	27	12	100	1.4	0.45	300
CMI-CRMCI1608-33NJ	33	12	100	1.2	0.55	300
CMI-CRMCI1608-39NJ	39	12	100	1.1	0.60	300
CMI-CRMCI1608-47NJ	47	12	100	0.9	0.70	300

- You can also contact us by e-mail : [coilmaster@coilmaster.com](mailto:coilmaster@coilmaster.com)
- All specifications are subject to change without notice.
- Update date : 2023.05.10

Part Number	Inductance (nH) S: ±0.3, J: ±5%	Q Min.	Test Frequency (MHz)	SRF (GHz) Min.	DC Resistance (ohm) Max.	Rated Current (mA) Max.
CMI-CRMCI1608-56NJ	56	12	100	0.9	0.75	300
CMI-CRMCI1608-68NJ	68	12	100	0.7	0.85	300
CMI-CRMCI1608-82NJ	82	12	100	0.6	0.95	300
CMI-CRMCI1608-R10J	100	12	100	0.6	1.00	300
CMI-CRMCI1608- R12J	120	8	50	0.5	1.20	300
CMI-CRMCI1608- R15J	150	8	50	0.5	1.20	300
CMI-CRMCI1608- R18J	180	8	50	0.4	1.30	300
CMI-CRMCI1608- R22J	220	8	50	0.4	1.50	300

- Rated Current : the DC current value having temperature increased 40 °c after thru DC current 2 hours at ambient temperature.
- Storage Temperature Range : -40°c ~ +85 °c
- Operating Temperature Range : -55°c ~ +125 °c

Note 1 : Circuit design, component placement, PCB trace size and thickness, airflow and other cooling. Provision all affect the part Temperature. Part temperature should be verified in the end application.

- **You can also contact us by e-mail : [coilmaster@coilmaster.com](mailto:coilmaster@coilmaster.com)**
- All specifications are subject to change without notice.
- Update date : 2023.05.10

## Electrical characteristics

INDUCTANCE vs FREQUENCY

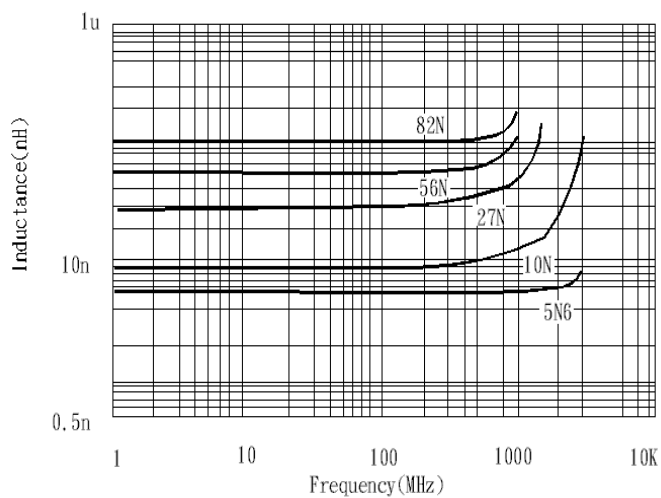

Q vs FREQUENCY

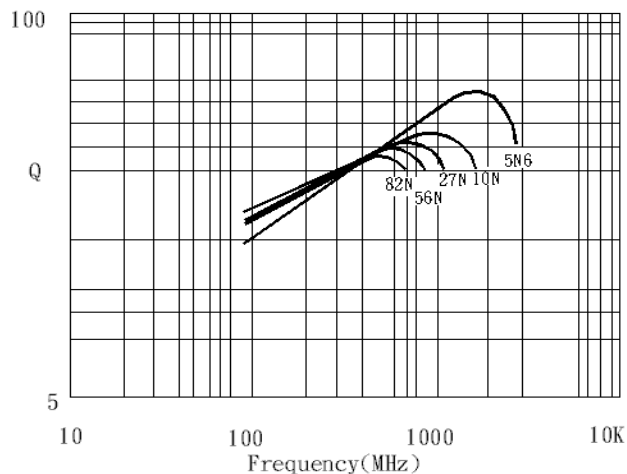

IMPEDANCE vs FREQUENCY

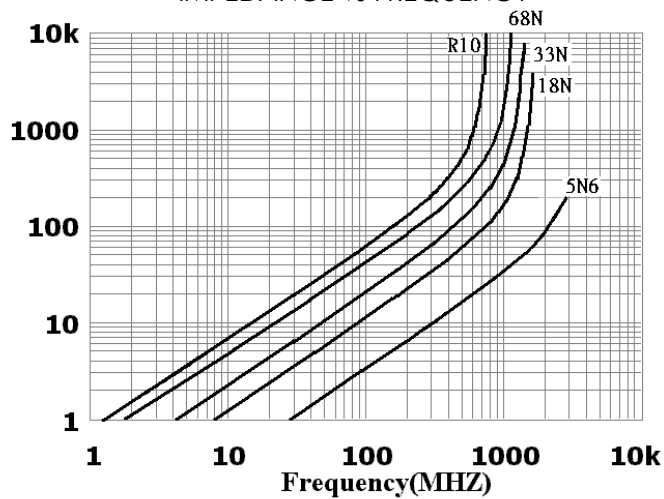

- You can also contact us by e-mail : [coilmaster@coilmaster.com](mailto:coilmaster@coilmaster.com)
- All specifications are subject to change without notice.
- Update date : 2023.05.10

## Packaging

(1) Package quantity : 4,000 (pcs/reel)

(2) Reel Dimensions (unit:mm)

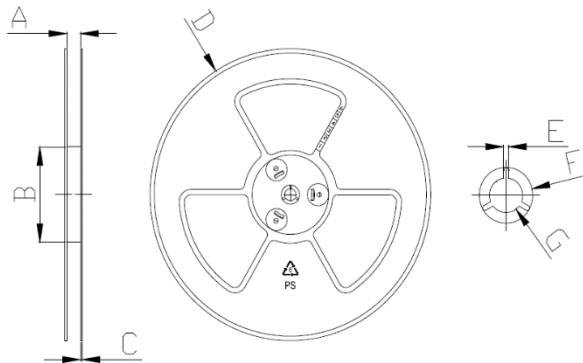

A	B	C	D	E	F	G
10.00	60.00	2.00	178.0	2.00	21.00	13.00
+1.50	+2.00	+0.50	+2.00	+0.50	+0.80	+0.80
-1.50	-2.00	-0.50	-2.00	-0.50	-0.80	-0.80

(3) Tape Dimensions

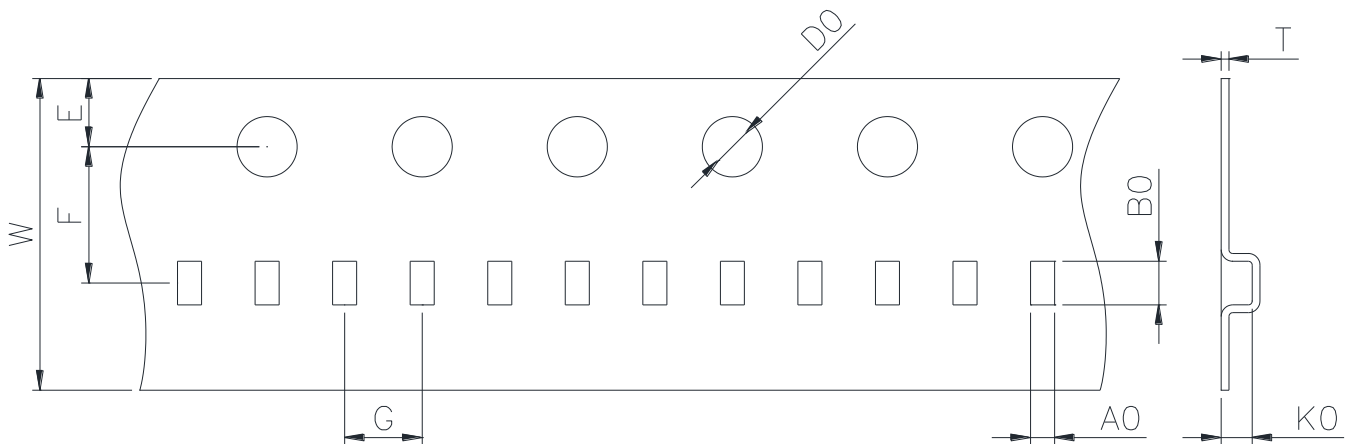

W	A0	B0	T	E	F	G	D0	K0
8.00	1.10	1.90	0.20	1.75	3.50	4.00	1.50	1.10
+0.20	+0.10	+0.10	+0.05	+0.10	+0.05	+0.10	+0.10	+0.05
-0.20	-0.10	-0.10	-0.05	-0.10	-0.05	-0.10	-0.00	-0.05

Korea Sales Office (KOREA) +82)31-904-1444 H.K Sales Office (HONGKONG) +852)2711-5551  
 China Sales Office (CHINA) +86)0758-683-1444 LA Sales Office (USA) +1)714-616-6989  
 Hungary Sales office (EUROPE) +36)1-404-5832

- You can also contact us by e-mail : [coilmaster@coilmaster.com](mailto:coilmaster@coilmaster.com)
- All specifications are subject to change without notice.
- Update date : 2023.05.10