

CMI-MMP3020BS-SERIES

Features

- ▶ Low profile, Compact design.
- ▶ Metal powder molding type for EMC protection.
- ▶ Available tape and reel for auto insertion.
- ▶ Halogen-Free
- ▶ RoHS compliant.

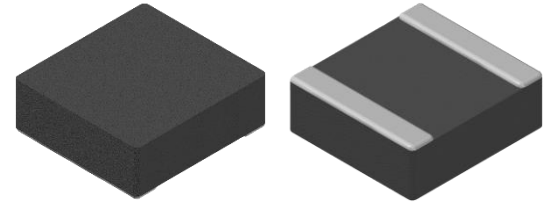

Applications

- ▶ For DC/DC converter
(Mobile phone, Tablet, TV, Audio, Display, HDD, SSD etc.)

Dimension (Unit:mm)

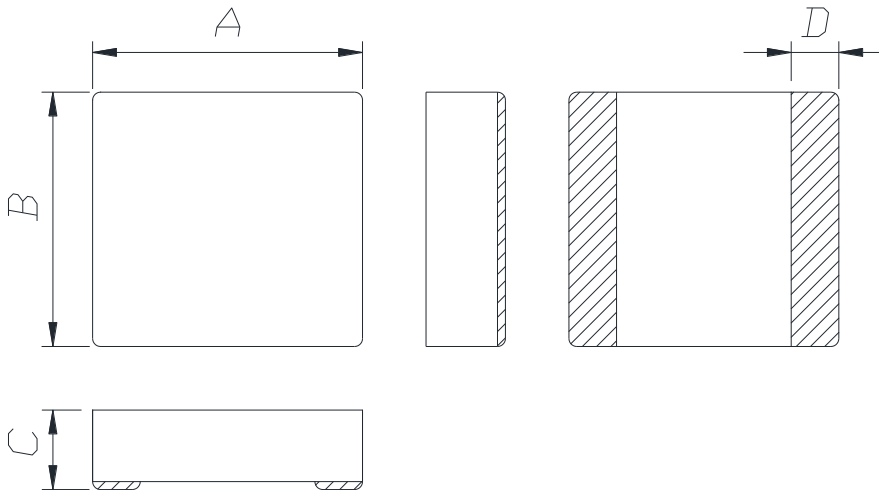

A	B	C	D
3.4 ±0.3	3.2 ±0.3	2.0 Max.	0.6 ±0.3

Land Pattern (Unit:mm)

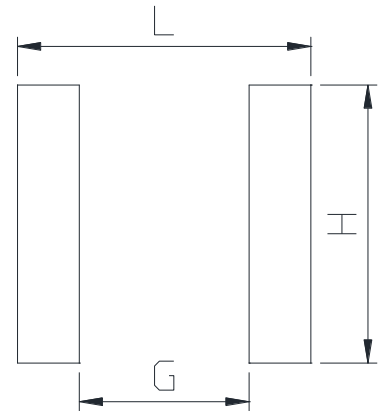

L	G	H
3.8	2.2	3.6

Regulation of part number

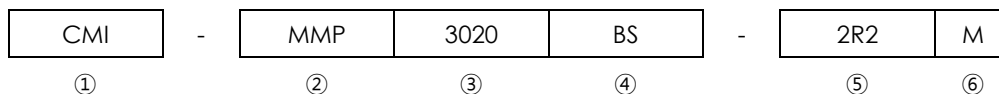

- ① CoilMaster's initial
- ② Series Name : Metal Molded Power inductor
- ③ Core Size (unit:mm)
- ④ Type
- ⑤ Typical inductance value (2.2uH)
- ⑥ Inductance tolerance ($\pm 20\%$)

Specifications

Part Number	Inductance (uH) $\pm 20\%$	DCR(mohm) Max.(Typ.)	Isat(A) Max.(Typ.)	Itemp(A) Max.(Typ.)	Test Frequency (Hz)
CMI-MMP3020BS-2R2M	2.2	60(52)	3.8(4.2)	3.0(3.2)	1M
CMI-MMP3020BS-4R7M	4.7	120(95)	2.5(2.8)	1.8(2.0)	1M

- Isat: When based on the inductance change rate (Approximately 30% below in the initial value)
- Itemp: When based on the temperature increase (Temperature increase of approximately 40°C by self heating)
- Operating Temperature Range (including self temperature) : -40°C ~ +125 °c

Note 1 : Circuit design, component placement, PCB trace size and thickness, airflow and other cooling. Provision all affect the part Temperature. Part temperature should be verified in the end application.

Electrical characteristics

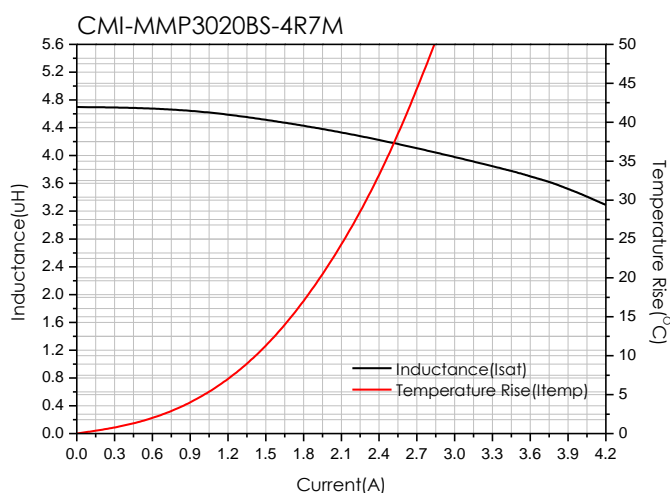
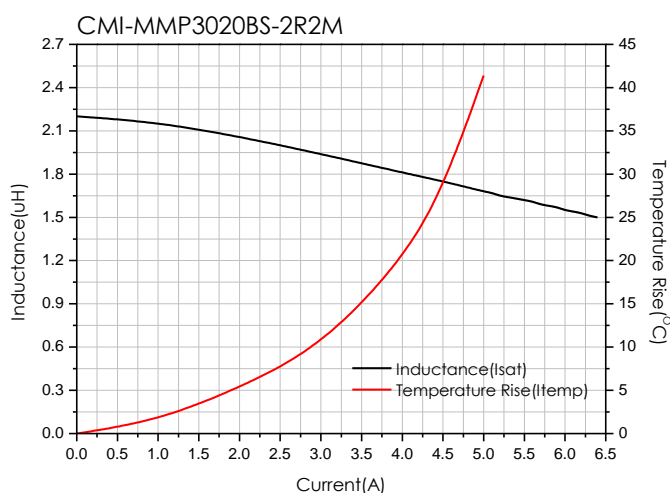

- You can also contact us by e-mail : coilmaster@coilmaster.com
- All specifications are subject to change without notice.
- Update date : 2023.05.15

Packaging

(1) Package quantity : 3,000 (pcs/reel)

(2) Reel Dimensions (unit:mm)



A	B	C	D	E	F	G
12.50	100.0	2.00	330.0	1.90	21.00	13.00
+1.00	+1.50	+0.10	+1.00	+0.40	+0.40	+0.40
-1.00	-1.50	-0.10	-1.00	-0.40	-0.40	-0.40

(3) Tape Dimensions

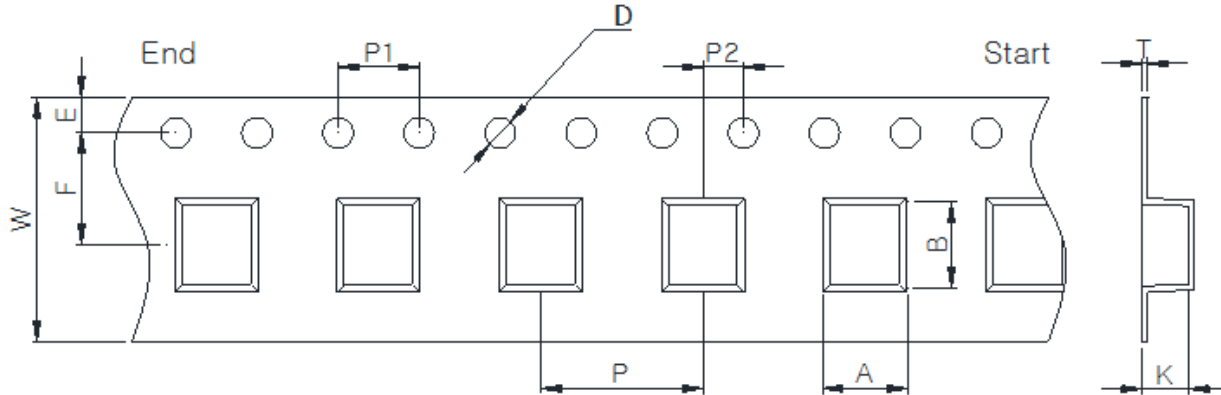

W	A	B	K	E	F	P	P1	P2	D	T
12.00	3.70	3.50	2.10	1.75	5.50	8.00	4.00	2.00	1.50	0.30
+0.30	+0.10	+0.10	+0.10	+0.10	+0.10	+0.10	+0.10	+0.10	+0.10	+0.05
-0.10	-0.10	-0.10	-0.10	-0.10	-0.10	-0.10	-0.10	-0.10	-0.00	-0.05

Korea Sales Office (KOREA) +82)31-904-1444
 China Sales Office (CHINA) +86)0758-683-1444
 Hungary Sales office (EUROPE) +36)1-404-5832

H.K Sales Office (HONGKONG) +852)2711-5551
 LA Sales Office (USA) +1)714-616-6989

• You can also contact us by e-mail : coilmaster@coilmaster.com

- All specifications are subject to change without notice.
- Update date : 2023.05.15

www.coilmaster.com