

# CMI-MMP4020HL-SERIES

## Features

- ▶ Low profile, Compact design.
- ▶ Metal powder molding type for EMC protection.
- ▶ Available tape and reel for auto insertion.
- ▶ Halogen-Free
- ▶ RoHS compliant.

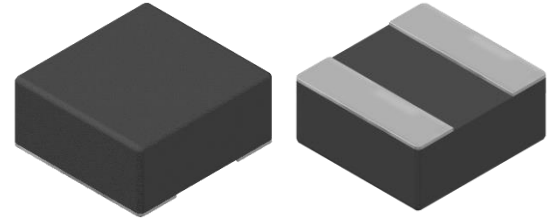

## Applications

- ▶ For DC/DC converter, AV equipment digital consumer electronics

## Dimension (Unit:mm)

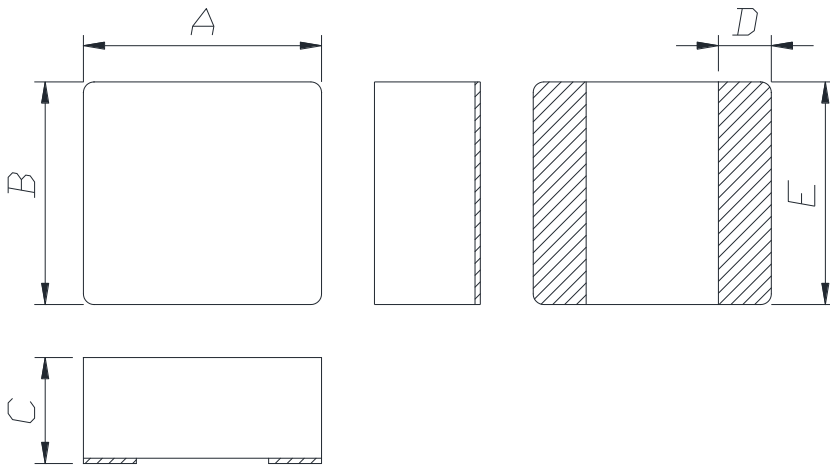

A	B	C	D	E
4.5 ±0.3	4.2 ±0.3	2.0 Max.	1.0 ±0.3	4.2 ±0.3

## Land Pattern (Unit:mm)

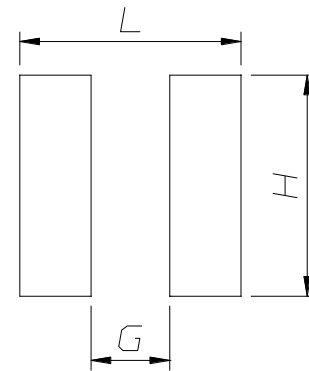

L	G	H
4.5	1.6	4.3

## Regulation of part number

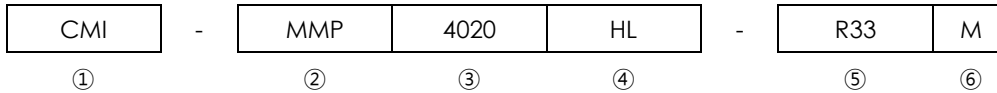

- ① CoilMaster's initial
- ② Series Name : Metal Molded Power inductor
- ③ Core Size (unit:mm)
- ④ Type
- ⑤ Typical inductance value (0.33uH)
- ⑥ Inductance tolerance (±20%)

## Specifications

Part Number	Inductance (uH) ±20%	DCR(mohm) Max.(Typ.)	Isat(A) Max.(Typ.)	Itemp(A) Max.(Typ.)	Test Frequency (Hz)
CMI-MMP4020HL-R33M	0.33	8.4(7.0)	15.5(17.5)	9.0(10.0)	1M
CMI-MMP4020HL-R47M	0.47	12(10)	14.5(16.5)	8.5(9.5)	1M
CMI-MMP4020HL-R82M	0.82	18(15)	11.5(13.5)	7.5(8.0)	1M
CMI-MMP4020HL-1R0M	1.0	24(20)	10.0(11.1)	7.0(7.5)	1M
CMI-MMP4020HL-1R5M	1.5	36(30)	8.0(9.0)	5.0(5.5)	1M
CMI-MMP4020HL-2R2M	2.2	48(40)	6.0(7.0)	4.8(5.3)	1M
CMI-MMP4020HL-3R3M	3.3	66(55)	4.5(5.0)	4.0(4.5)	1M
CMI-MMP4020HL-4R7M	4.7	96(80)	4.1(4.6)	3.3(3.7)	1M
CMI-MMP4020HL-6R8M	6.8	156(130)	3.6(4.0)	3.0(3.3)	1M
CMI-MMP4020HL-8R2M	8.2	158(140)	3.5(3.9)	2.6(2.9)	1M
CMI-MMP4020HL-100M	10	222(185)	3.2(3.5)	2.4(2.7)	1M
CMI-MMP4020HL-150M	15	288(240)	2.5(3.0)	1.8(2.0)	1M

- Isat: When based on the inductance change rate (Approximately 30% below in the initial value)
- Itemp: When based on the temperature increase (Temperature increase of approximately 40°C by self heating)
- Operating Temperature Range (including self temperature) : -40°C ~ +125 °c

Note 1 : Circuit design, component placement, PCB trace size and thickness, airflow and other cooling. Provision all affect the part Temperature. Part temperature should be verified in the end application.

▪ **You can also contact us by e-mail : [coilmaster@coilmaster.com](mailto:coilmaster@coilmaster.com)**

- All specifications are subject to change without notice.
- Update date : 2023.05.10

[www.coilmaster.com](http://www.coilmaster.com)

# Electrical characteristics

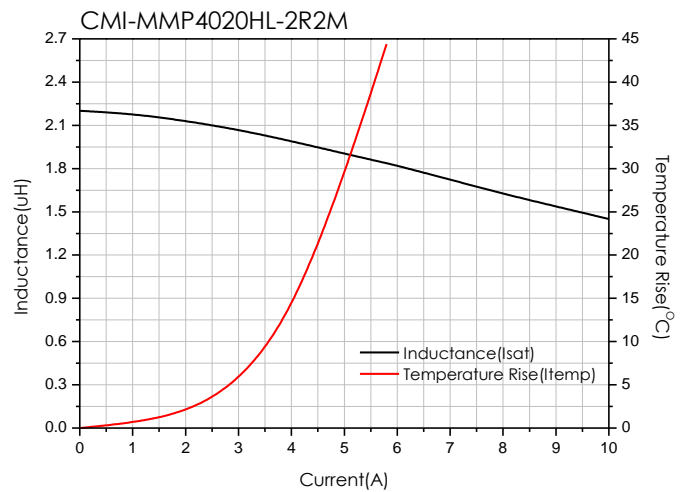
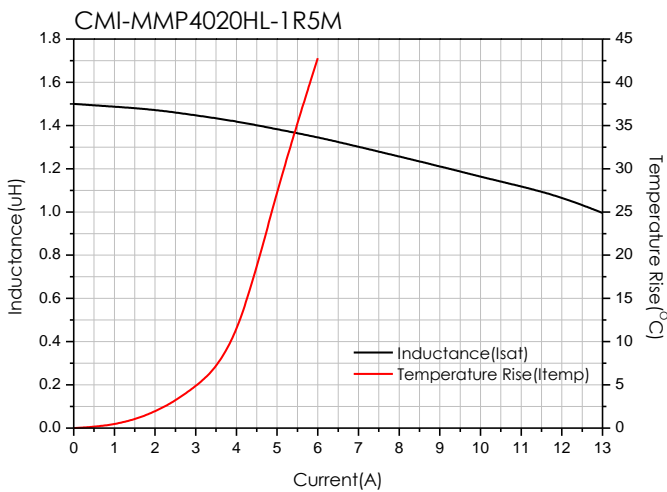
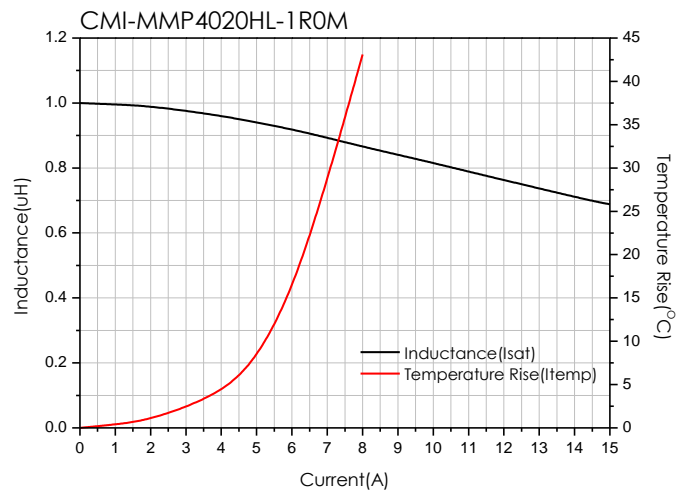
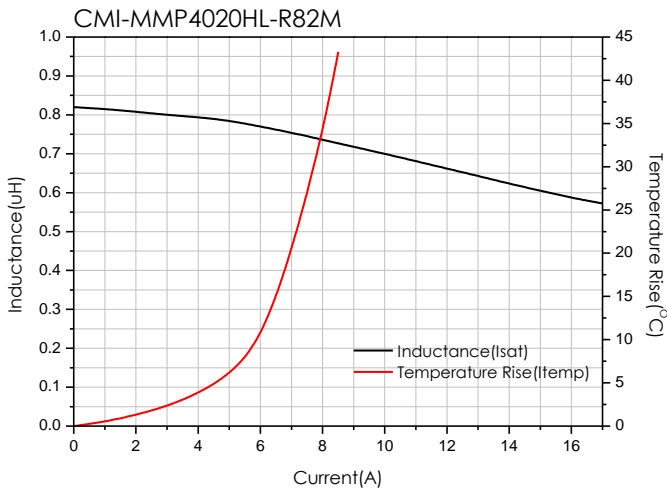
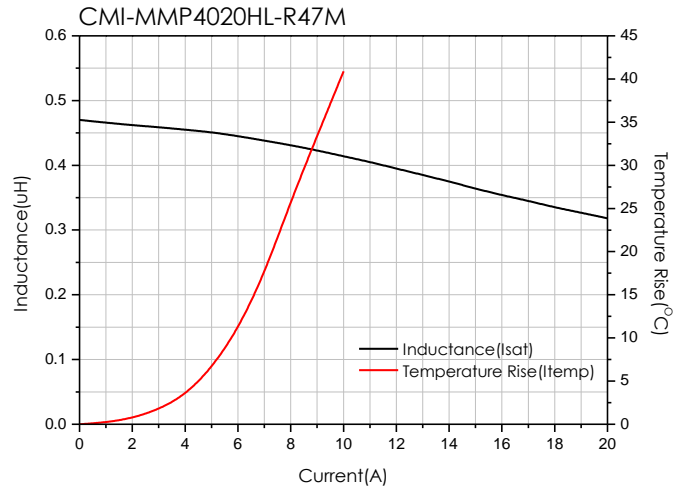
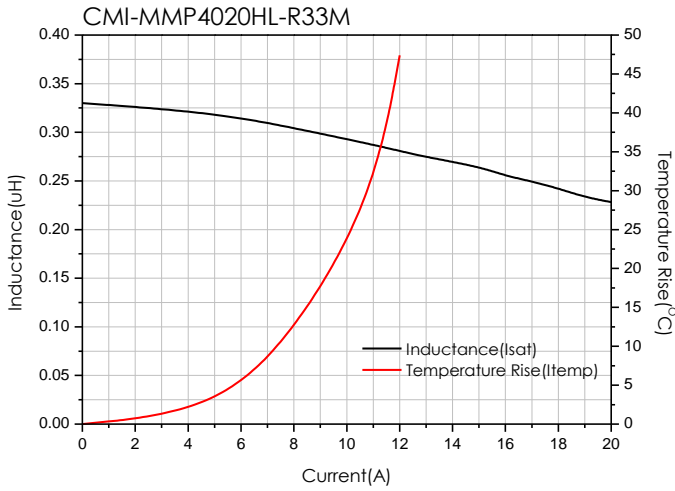

- You can also contact us by e-mail : [coilmaster@coilmaster.com](mailto:coilmaster@coilmaster.com)
- All specifications are subject to change without notice.
- Update date : 2023.05.10

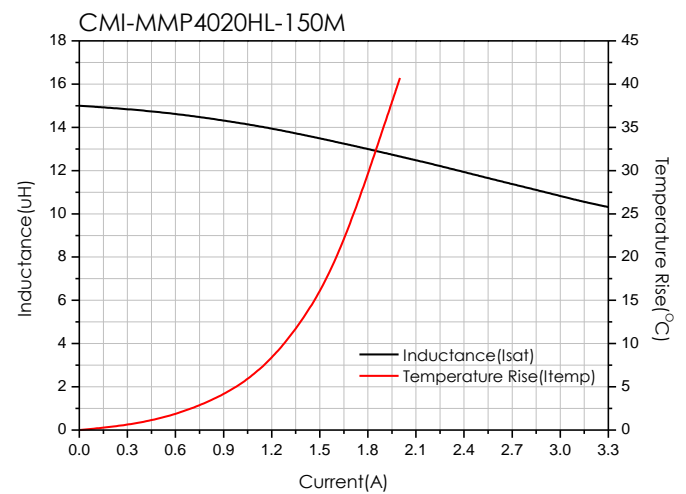
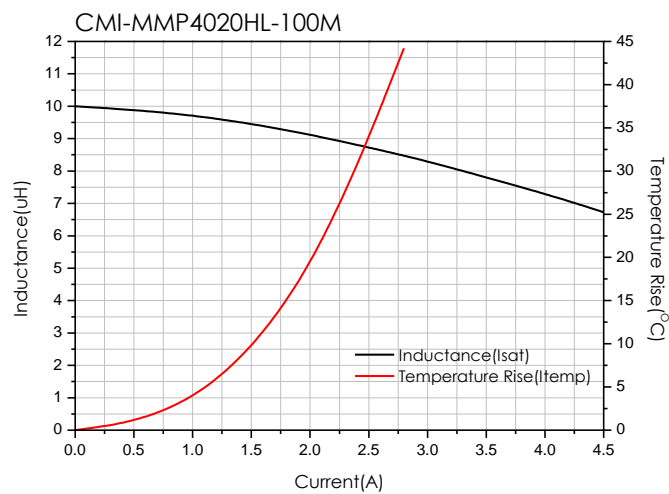
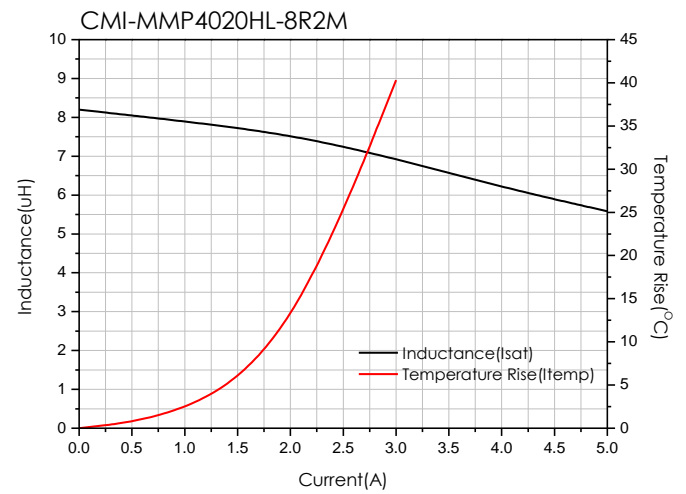
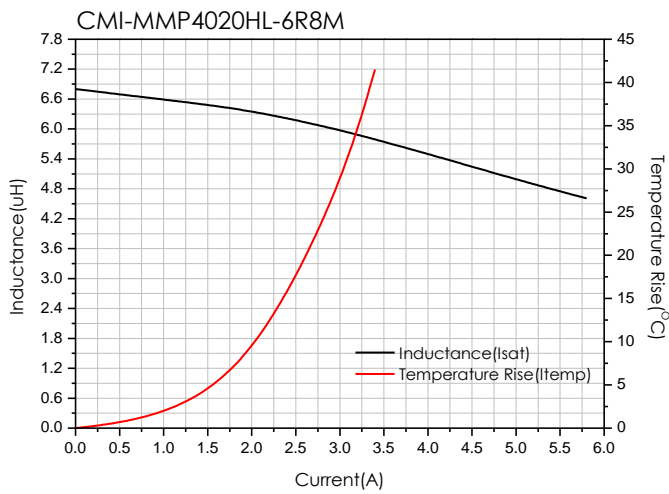
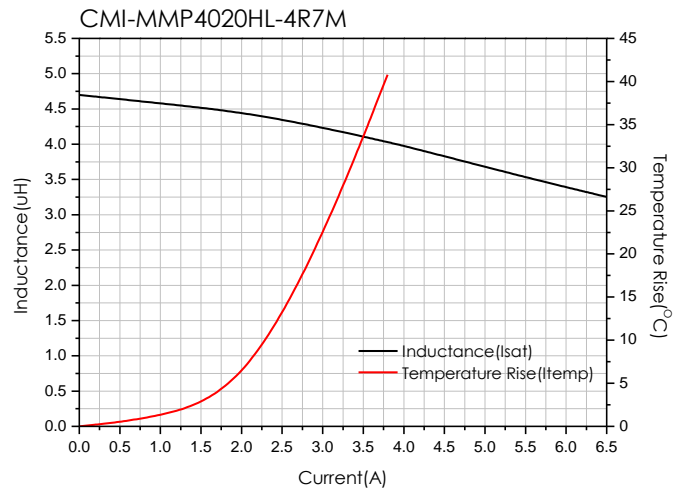
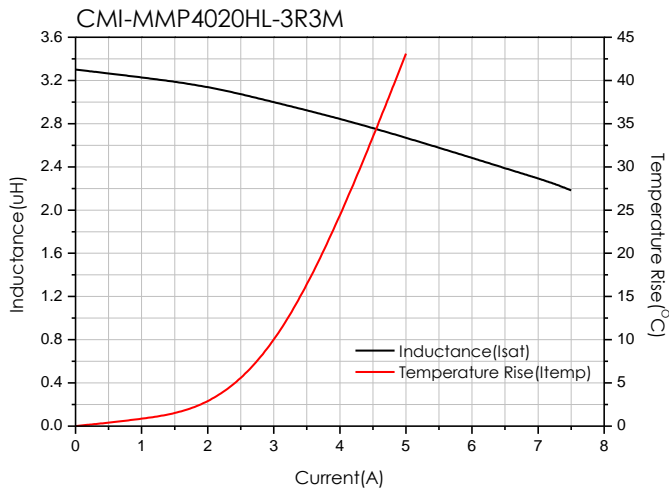

- You can also contact us by e-mail : [coilmaster@coilmaster.com](mailto:coilmaster@coilmaster.com)
- All specifications are subject to change without notice.
- Update date : 2023.05.10

## Packaging

(1) Package quantity : 3,000 (pcs/reel)

(2) Reel Dimensions (unit:mm)

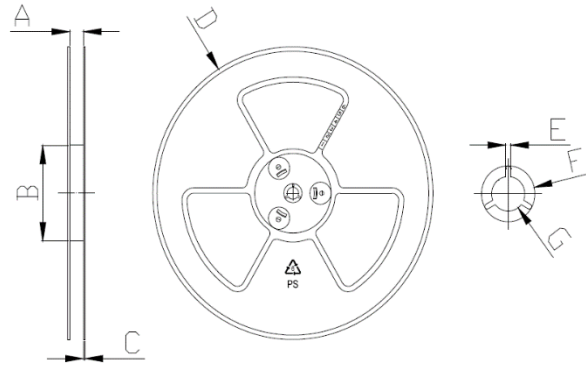

A	B	C	D	E	F	G
12.50	100.0	2.00	330.0	1.90	21.00	13.00
+1.00	+1.50	+0.10	+1.00	+0.40	+0.40	+0.40
-1.00	-1.50	-0.10	-1.00	-0.40	-0.40	-0.40

(3) Tape Dimensions

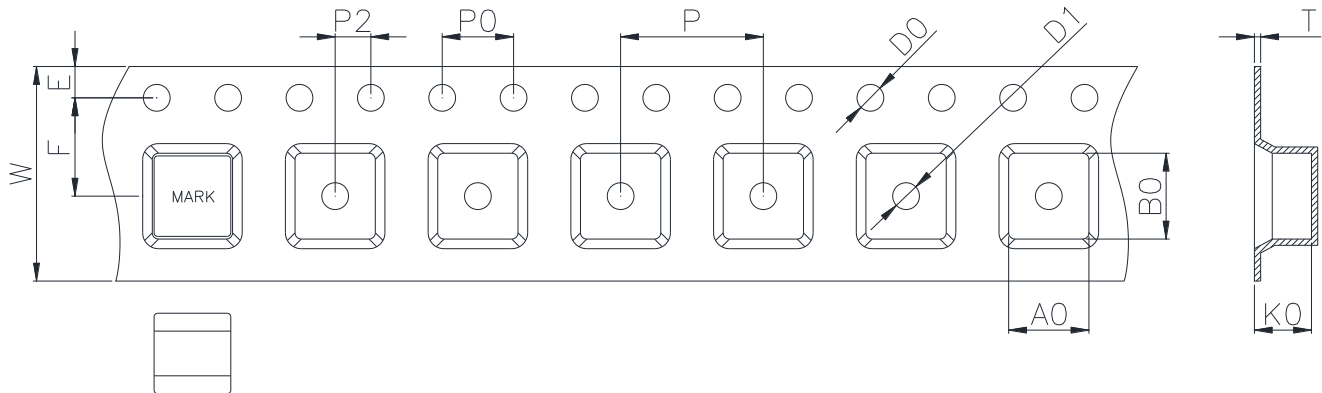

W	A	B	K	E	F	P	P1	P2	D	T
12.00	4.60	4.90	2.20	1.75	5.50	8.00	4.00	2.00	1.50	0.35
+0.30	+0.10	+0.10	+0.10	+0.15	+0.10	+0.10	+0.10	+0.10	+0.10	+0.05
-0.10	-0.10	-0.10	-0.10	-0.10	-0.10	-0.10	-0.10	-0.10	-0.00	-0.05

Korea Sales Office (KOREA) +82)31-904-1444  
 China Sales Office (CHINA) +86)0758-683-1444  
 Hungary Sales office (EUROPE) +36)1-404-5832

H.K Sales Office (HONGKONG) +852)2711-5551  
 LA Sales Office (USA) +1)714-616-6989

• You can also contact us by e-mail : [coilmaster@coilmaster.com](mailto:coilmaster@coilmaster.com)

- All specifications are subject to change without notice.
- Update date : 2023.05.10

[www.coilmaster.com](http://www.coilmaster.com)