

# CMI-MMPF7030H2-SB SERIES

## Features

- ▶ Low AC Loss.
- ▶ Metal powder molding type for EMC protection.
- ▶ Lower DCR with applying flat wire.
- ▶ Available tape and reel for auto insertion.
- ▶ Halogen-Free.
- ▶ RoHS compliant.

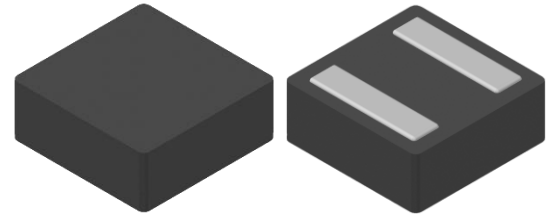

## Applications

- ▶ For DC/DC Converter

## Dimension (Unit:mm)

## Land Pattern (Unit:mm)

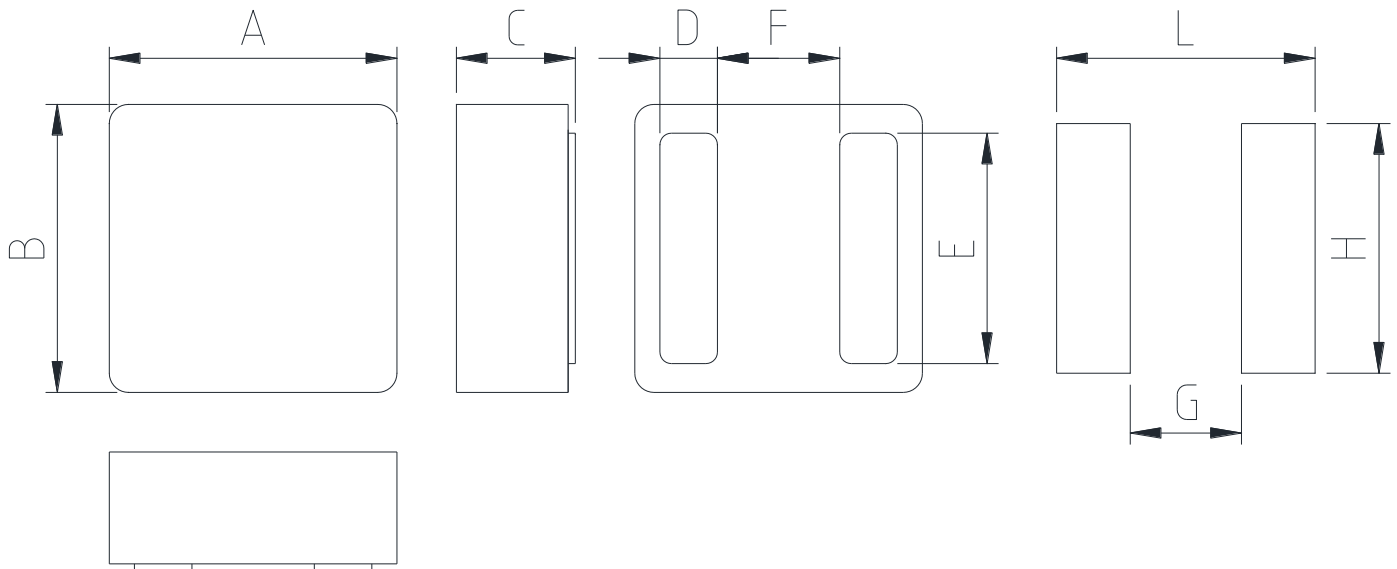

A	B	C	D	E	F	G	H	L
7.5 ±0.2	7.5 ±0.2	3.1 Max.	1.5 ±0.2	6.0 Typ.	3.2 Typ.	2.90	6.50	6.74



# Electrical characteristics

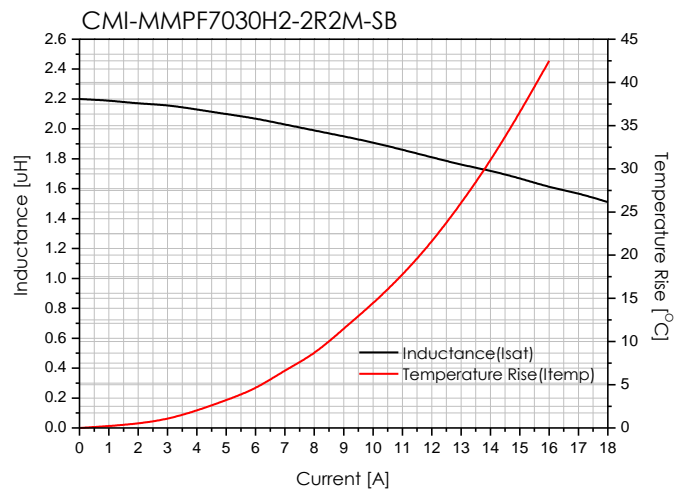
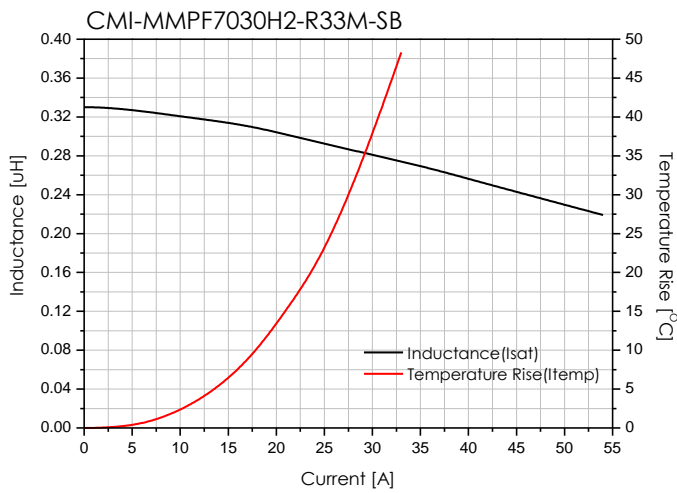
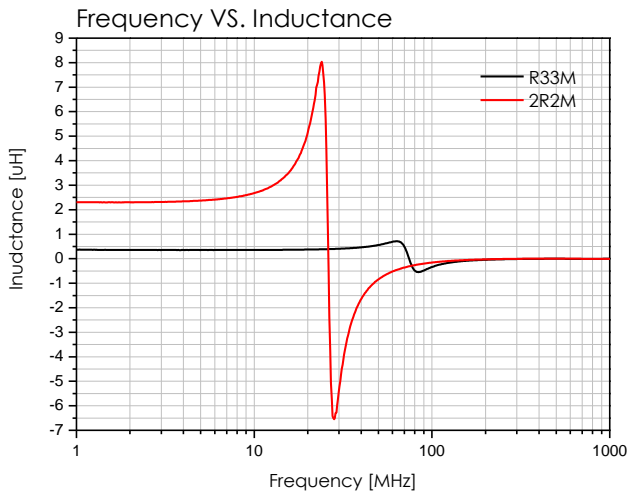

- You can also contact us by e-mail : [coilmaster@coilmaster.com](mailto:coilmaster@coilmaster.com)
- All specifications are subject to change without notice.
- Update date : 2023.07.13

## Packaging

(1) Package quantity : 1,000 (pcs/reel)

(2) Reel Dimensions (unit:mm)

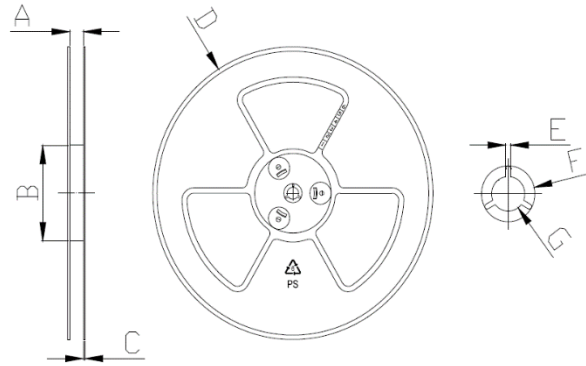

A	B	C	D	E	F	G
16.50	100.0	2.00	330.0	2.30	21.50	13.00
+0.50	+1.00	+0.20	+3.00	+0.30	+0.30	+0.50
-0.50	-1.00	-0.20	-3.00	-0.30	-0.30	-0.20

(3) Tape Dimensions

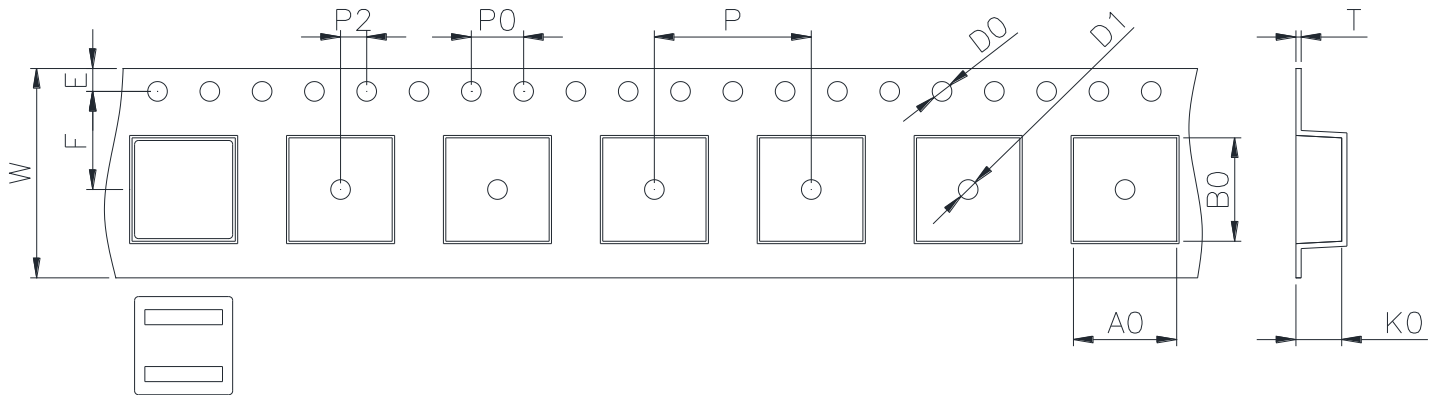

W	A0	B0	KO	E	F	P	P0	P2	D0/D1	T
16.00	7.90	7.90	3.50	1.75	7.50	8.00	4.00	2.00	1.50	0.40
+0.30	+0.10	+0.10	+0.10	+0.10	+0.10	+0.10	+0.10	+0.10	+0.10	+0.05
-0.10	-0.10	-0.10	-0.10	-0.10	-0.10	-0.10	-0.10	-0.10	-0.00	-0.05

Korea Sales Office (KOREA) +82)31-904-1444  
 China Sales Office (CHINA) +86)0758-683-1444  
 Hungary Sales office (EUROPE) +36)1-404-5832

H.K Sales Office (HONGKONG) +852)2711-5551  
 LA Sales Office (USA) +1)714-616-6989

• You can also contact us by e-mail : [coilmaster@coilmaster.com](mailto:coilmaster@coilmaster.com)

- All specifications are subject to change without notice.
- Update date : 2023.07.13

[www.coilmaster.com](http://www.coilmaster.com)