

CMI-MMPP4020LH-SERIES

Features

- ▶ Low profile.
- ▶ Metal powder molding type for EMC protection.
- ▶ Available tape and reel for auto insertion.
- ▶ Halogen-Free.
- ▶ RoHS compliant.

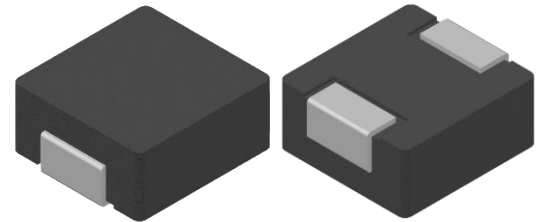

Applications

- ▶ For DC/DC converter, AV equipment digital consumer electronics

Dimension (Unit:mm)

Land Pattern (Unit:mm)

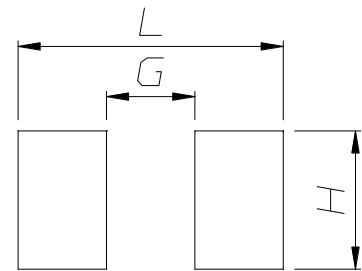
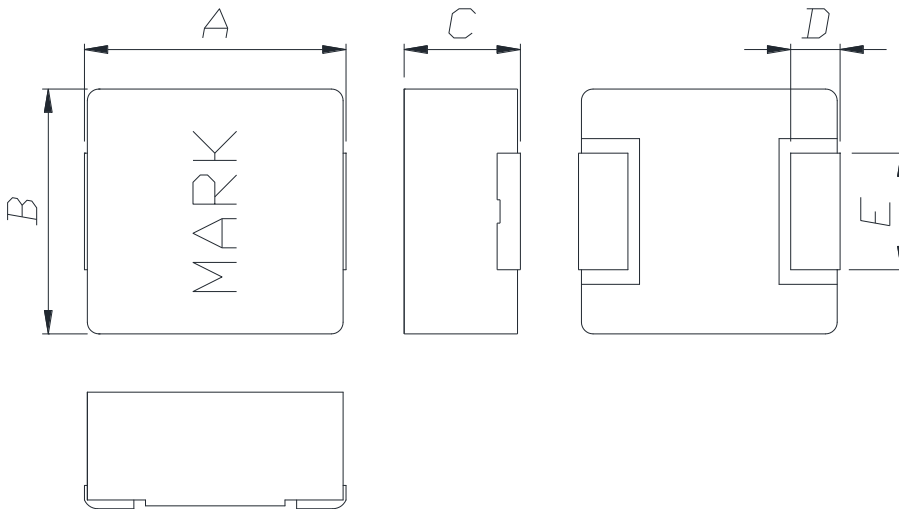

A	B	C	D	E
4.4 ±0.35	4.2 ±0.25	2.0 Max.	0.8 ±0.2	2.0 ±0.2

L	G	H
4.8	1.6	2.5

Regulation of part number

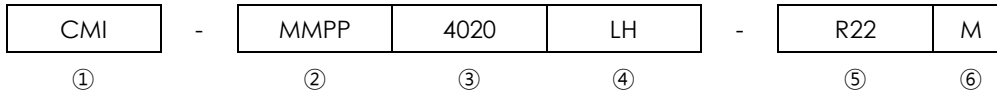

- ① CoilMaster's initial
- ② Series Name : Metal Molded Pin type Power inductor
- ③ Core Size (unit:mm)
- ④ Material
- ⑤ Typical inductance value (0.22uH)
- ⑥ Inductance tolerance ($\pm 20\%$)

Specifications

Part Number	Inductance (uH) $\pm 20\%$	DCR(mohm) Max.(Typ.)	Isat(A) Max.(Typ.)	Itemp(A) Max.(Typ.)	Test Frequency (Hz)
CMI-MMPP4020LH-R22M	0.22	6.4(5.3)	23.0(28.0)	11.0(12.0)	1M

- Isat: When based on the inductance change rate (Approximately 30% below in the initial value)
- Itemp: When based on the temperature increase (Temperature increase of approximately 40°C by self heating)
- Operating Temperature Range (including self temperature) : -40°C ~ +125 °c

Note 1 : Circuit design, component placement, PCB trace size and thickness, airflow and other cooling. Provision all affect the part Temperature. Part temperature should be verified in the end application.

Electrical characteristics

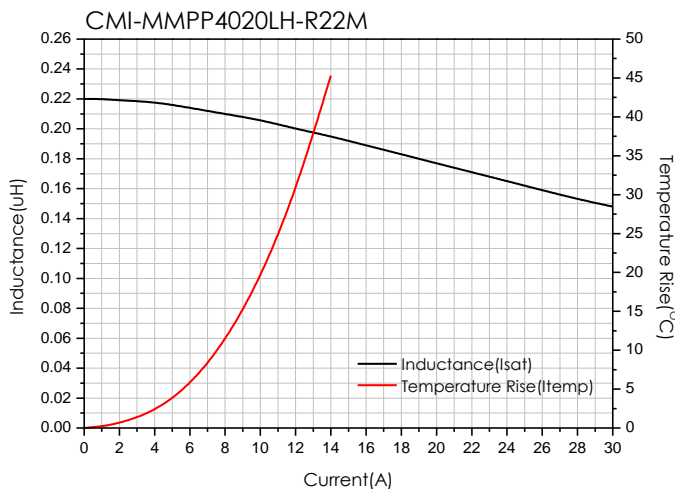

- You can also contact us by e-mail : coilmaster@coilmaster.com
- All specifications are subject to change without notice.
- Update date : 2023.06.22

Packaging

(1) Package quantity : 3,000 (pcs/reel)

(2) Reel Dimensions (unit:mm)

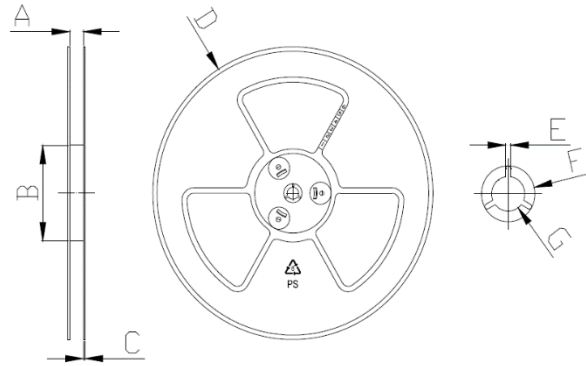

A	B	C	D	E	F	G
12.50	100.0	2.00	330.0	1.90	21.00	13.00
+1.00	+1.50	+0.10	+1.00	+0.40	+0.40	+0.40
-1.00	-1.50	-0.10	-1.00	-0.40	-0.40	-0.40

(3) Tape Dimensions

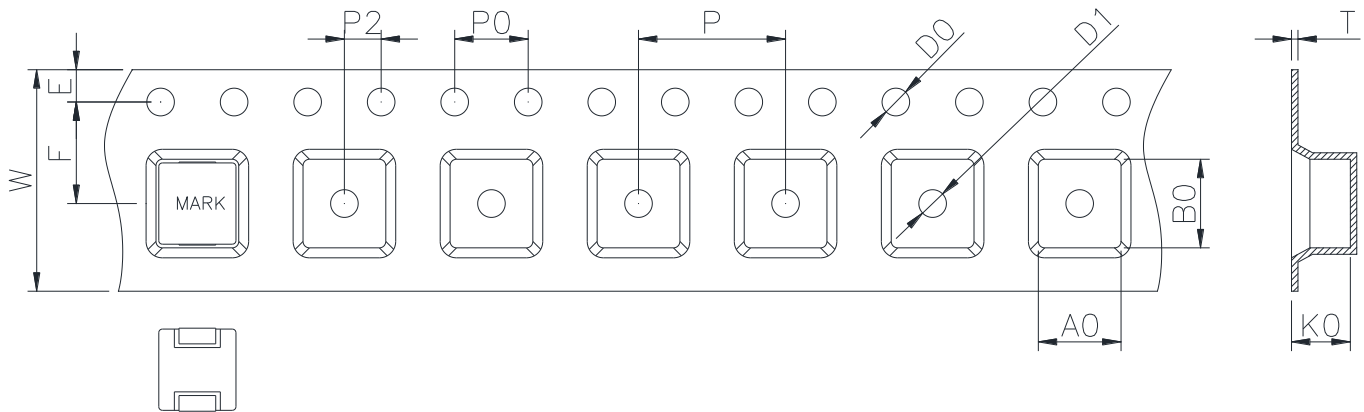

W	A0	B0	K0	E	F	P	P0	P2	D0/D1	T
12.00	4.60	4.90	2.20	1.75	5.50	8.00	4.00	2.00	1.50	0.35
+0.30	+0.10	+0.10	+0.10	+0.10	+0.10	+0.10	+0.10	+0.10	+0.10	+0.05
-0.10	-0.00	-0.00	-0.10	-0.10	-0.10	-0.10	-0.10	-0.10	-0.00	-0.05

Korea Sales Office (KOREA) +82)31-904-1444
 China Sales Office (CHINA) +86)0758-683-1444
 Hungary Sales office (EUROPE) +36)1-404-5832

H.K Sales Office (HONGKONG) +852)2711-5551
 LA Sales Office (USA) +1)714-616-6989

• You can also contact us by e-mail : coilmaster@coilmaster.com

- All specifications are subject to change without notice.
- Update date : 2023.06.22

www.coilmaster.com