

# CMI-CMMP7018HL-SERIES

## Features

- ▶ Low profile and Compact design.
- ▶ Metal powder molding type for EMC protection.
- ▶ Available tape and reel for auto insertion.
- ▶ Halogen-Free.
- ▶ RoHS compliant.
- ▶ AEC-Q200 qualified.

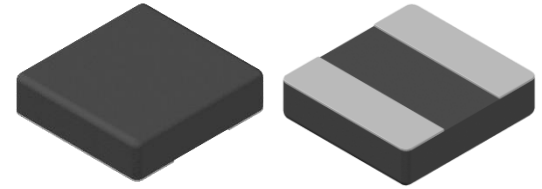

## Applications

- ▶ Car navigation, Car stereo and Car accessories, ADAS ECU, In-C-Vehicle camera (View camera, Sensing camera), Automotive communication module.

## Dimension (Unit:mm)

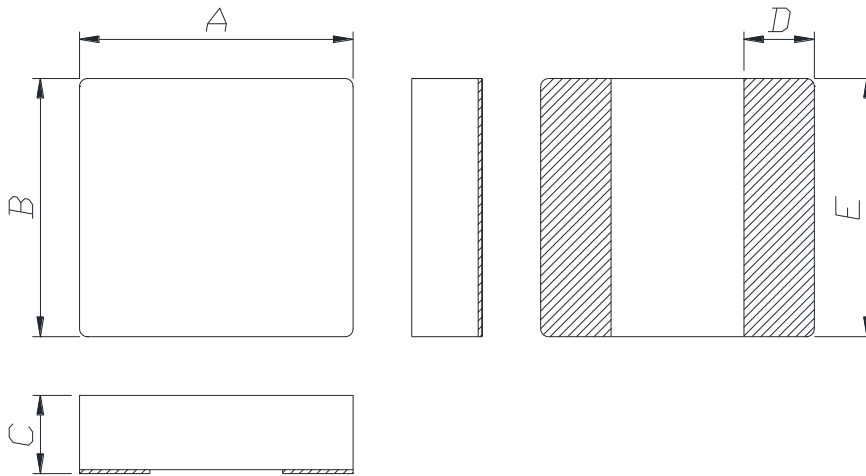

A	B	C	D	E
7.0 ±0.3	6.6 ±0.3	1.8 Max.	1.8 ±0.3	6.6 ±0.3

## Land Pattern (Unit:mm)

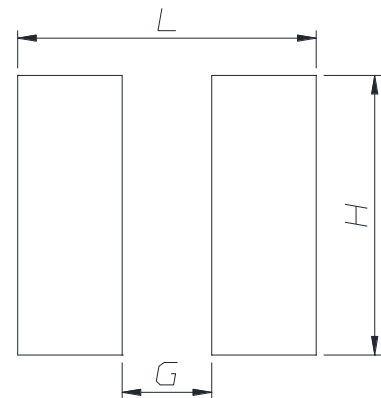

L	G	H
8.0	2.4	7.5

## Regulation of part number

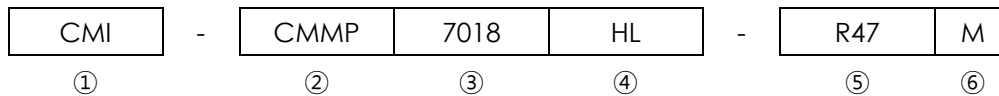

- ① CoilMaster's initial
- ② Series Name : Car Metal Molded Power inductor
- ③ Core Size (unit:mm)
- ④ Type
- ⑤ Typical inductance value (0.47uH)
- ⑥ Inductance tolerance (±20%)

## Specifications

Part Number	Inductance (uH) ±20%	DCR(mohm) Max.(Typ.)	Isat(A) Max.(Typ.)	Itemp(A) Max.(Typ.)	Test Frequency (Hz)
CMI-CMMP7018HL-R47M	0.47	9.6(8)	25.0(27.0)	9.5(10.5)	1M
CMI-CMMP7018HL-R68M	0.68	12(10)	18.0(20.0)	8.7(9.7)	1M
CMI-CMMP7018HL-1R0M	1.0	19.2(16)	14.0(16.0)	8.0(8.8)	1M
CMI-CMMP7018HL-2R2M	2.2	34.2(28.5)	8.5(9.5)	5.5(6.1)	1M
CMI-CMMP7018HL-3R3M	3.3	48(40)	7.7(8.5)	4.9(5.4)	1M
CMI-CMMP7018HL-4R7M	4.7	72(60)	6.4(7.1)	4.1(4.5)	1M
CMI-CMMP7018HL-6R8M	6.8	102(85)	5.4(6.0)	3.7(4.1)	1M
CMI-CMMP7018HL-100M	10	150(125)	4.5(5.0)	3.0(3.3)	1M

- Isat: When based on the inductance change rate (Approximately 30% below in the initial value)
- Itemp: When based on the temperature increase (Temperature increase of approximately 40°C by self heating)
- Operating Temperature Range (including self temperature) : -40°C ~ +150 °c

Note 1 : Circuit design, component placement, PCB trace size and thickness, airflow and other cooling. Provision all affect the part Temperature. Part temperature should be verified in the end application.

▪ **You can also contact us by e-mail : [coilmaster@coilmaster.com](mailto:coilmaster@coilmaster.com)**

- All specifications are subject to change without notice.
- Update date : 2023.05.25

[www.coilmaster.com](http://www.coilmaster.com)

# Electrical characteristics

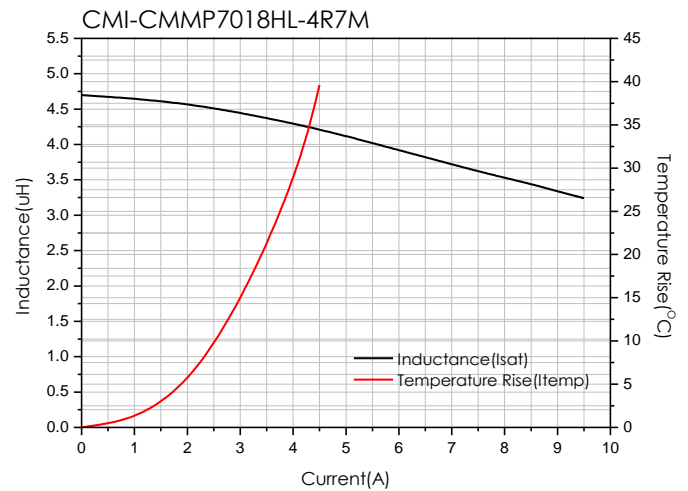
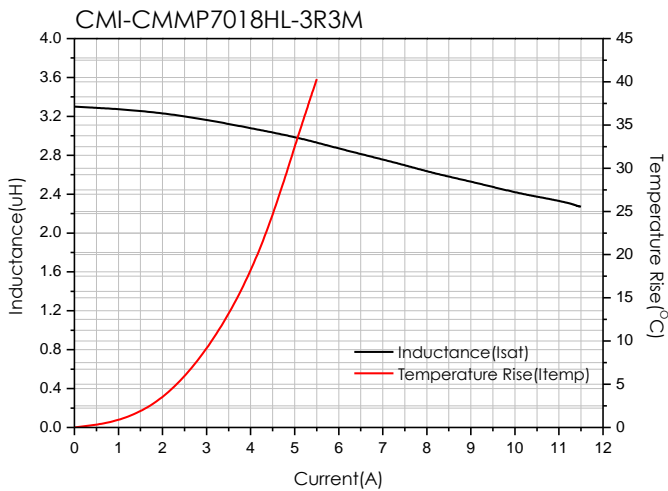
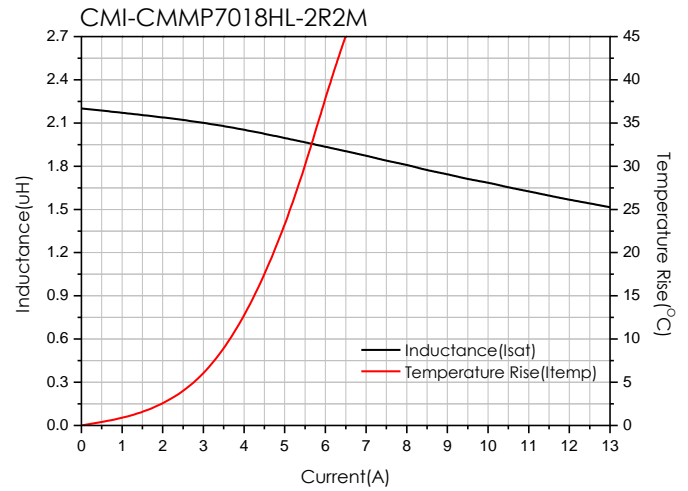
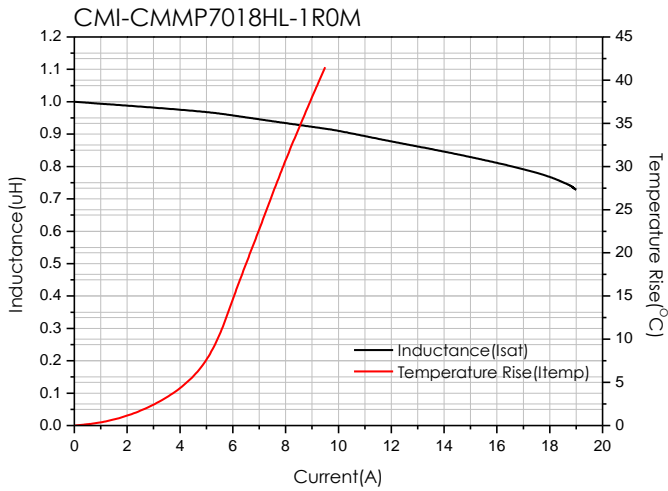
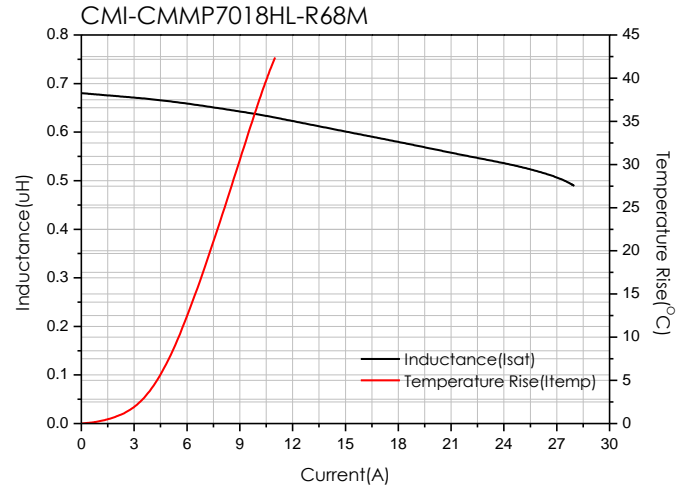
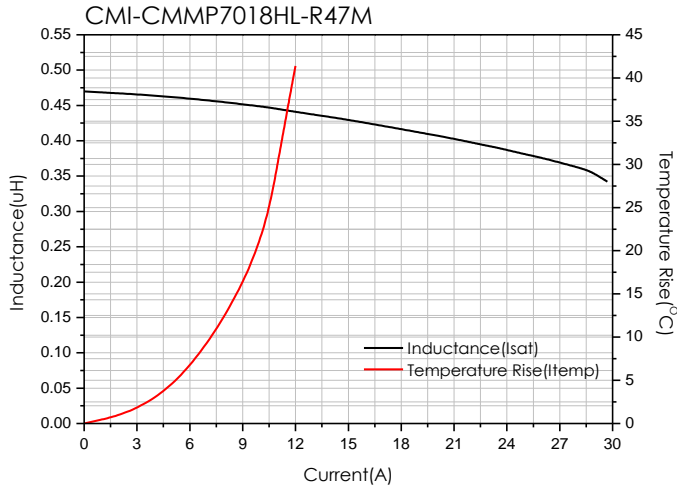

- You can also contact us by e-mail : [coilmaster@coilmaster.com](mailto:coilmaster@coilmaster.com)
- All specifications are subject to change without notice.
- Update date : 2023.05.25

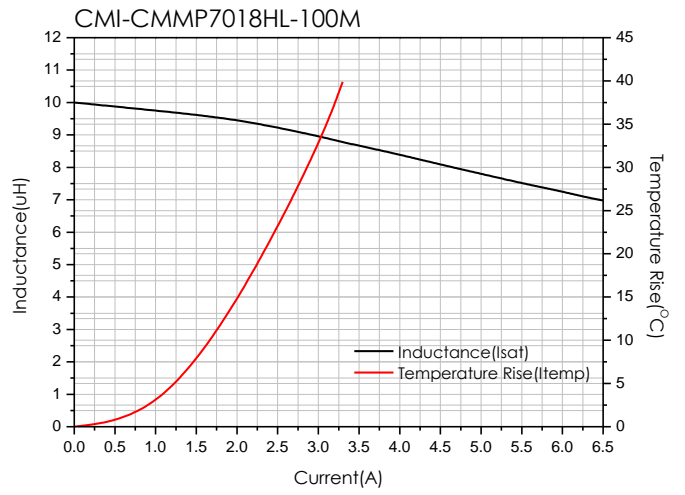
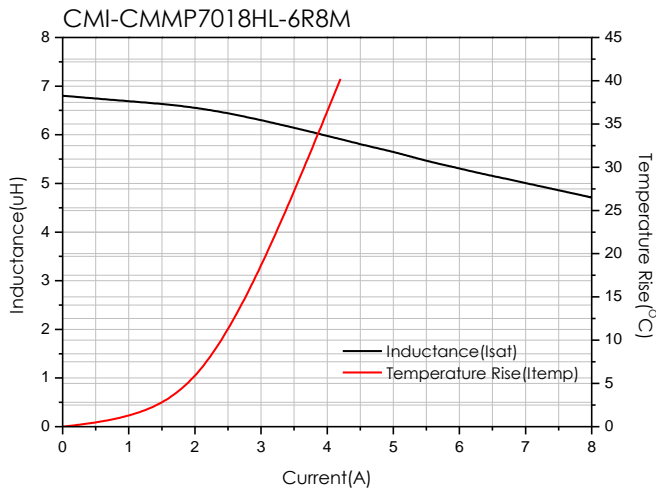

- You can also contact us by e-mail : [coilmaster@coilmaster.com](mailto:coilmaster@coilmaster.com)
- All specifications are subject to change without notice.
- Update date : 2023.05.25

## Packaging

(1) Package quantity : 2,000 (pcs/reel)

(2) Reel Dimensions (unit:mm)

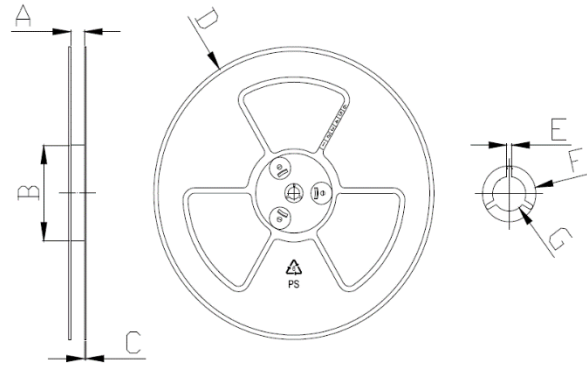

A	B	C	D	E	F	G
16.50	100.0	2.00	330.0	2.30	21.50	13.00
+0.50	+1.00	+0.10	+3.00	+0.30	+0.30	+0.50
-0.50	-1.00	-0.10	-3.00	-0.30	-0.30	-0.20

(3) Tape Dimensions

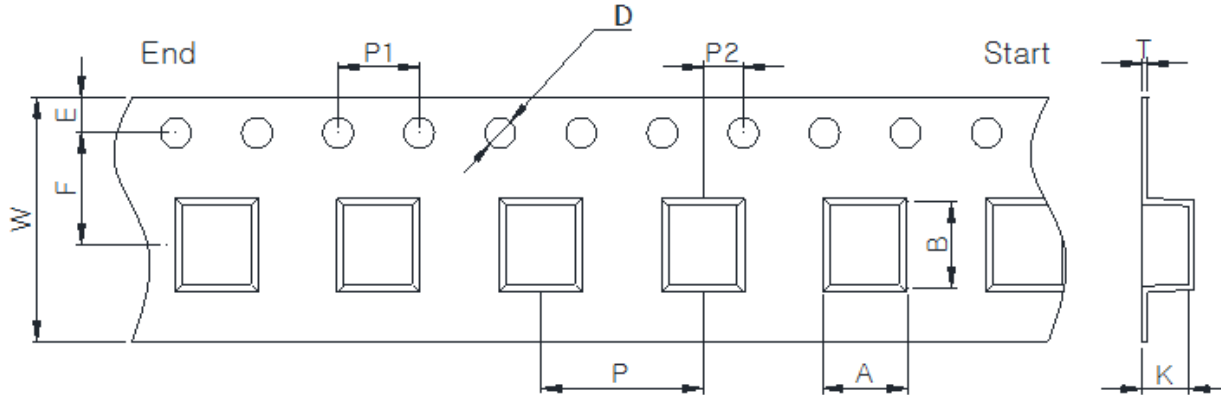

W	A	B	K	E	F	P	P1	P2	D	T
16.00	7.00	7.50	2.20	1.75	7.50	12.00	4.00	2.00	1.50	0.30
+0.30	+0.10	+0.10	+0.10	+0.10	+0.10	+0.10	+0.10	+0.10	+0.10	+0.05
-0.10	-0.10	-0.10	-0.10	-0.10	-0.10	-0.10	-0.10	-0.10	-0.00	-0.05

Korea Sales Office (KOREA) +82)31-904-1444  
 China Sales Office (CHINA) +86)0758-683-1444  
 Hungary Sales office (EUROPE) +36)1-404-5832

H.K Sales Office (HONGKONG) +852)2711-5551  
 LA Sales Office (USA) +1)714-616-6989

• You can also contact us by e-mail : [coilmaster@coilmaster.com](mailto:coilmaster@coilmaster.com)

- All specifications are subject to change without notice.
- Update date : 2023.05.25

[www.coilmaster.com](http://www.coilmaster.com)