

# CMI-CMMPF15100QL-SB SERIES

## Features

- ▶ Metal powder molding type for EMC protection.
- ▶ Lower DCR with applying flat wire.
- ▶ Available tape and reel for auto insertion.
- ▶ Halogen-Free.
- ▶ RoHS compliant.
- ▶ AEC-Q200 qualified.

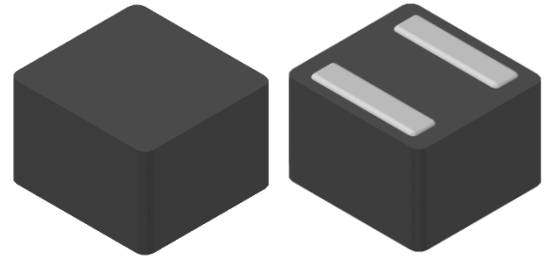

## Applications

- ▶ Equipment using for automobiles (ECM, Airbags, Headlights, Electronic Power steering, Motors, ABS, other)

## Dimension (Unit:mm)

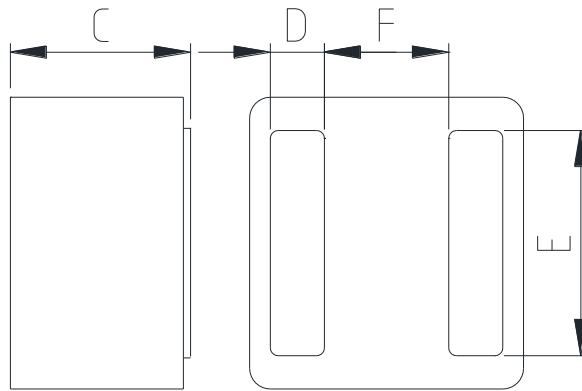
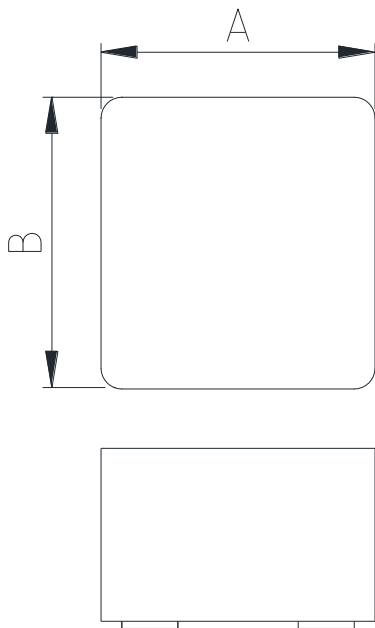

## Land Pattern (Unit:mm)

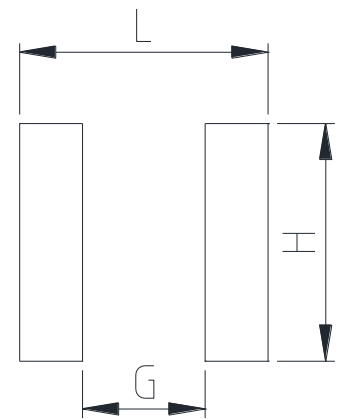

A	B	C	D	E	F	G	H	L
15.2 ±0.5	16.2 ±0.5	11.0 Max.	3.0 ±0.2	12.5 Typ.	6.9 Typ.	6.80	13.20	13.78

## Regulation of part number

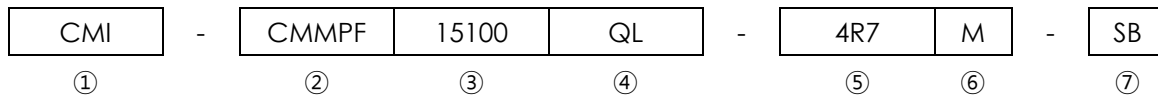

- ① CoilMaster's initial
- ② Series Name : Car Metal Molded Power inductor Flat wire type.
- ③ Core Size (unit:mm)
- ④ Material
- ⑤ Typical inductance value (4.7uH)
- ⑥ Inductance tolerance ( $\pm 20\%$ )
- ⑦ Type (SB)

## Specifications

Part Number	Inductance (uH) $\pm 20\%$	DCR(mohm) Max.(Typ.)	Isat(A) Max.(Typ.)	Itemp(A) Max.(Typ.)	Test Frequency (Hz)
CMI-CMMPF15100QL-4R7M-SB	4.7	3.0(2.5)	45.0(50.0)	33.0(35.0)	1M
CMI-CMMPF15100QL-6R8M-SB	6.8	4.2(3.5)	32.0(37.0)	31.0(33.0)	1M
CMI-CMMPF15100QL-8R2M-SB	8.2	6.0(5.0)	30.0(35.0)	30.0(32.0)	1M
CMI-CMMPF15100QL-100M-SB	10	7.0(6.0)	27.0(32.0)	28.0(30.0)	1M
CMI-CMMPF15100QL-150M-SB	15	10.3(8.6)	23.0(25.0)	24.0(26.0)	1M
CMI-CMMPF15100QL-220M-SB	22	13(11)	20.0(22.0)	23.3(24.5)	1M
CMI-CMMPF15100QL-330M-SB	33	18.6(15.5)	15.0(17.0)	21.0(22.0)	1M

- Isat: When based on the inductance change rate (Approximately 30% below in the initial value)
- Itemp: When based on the temperature increase (Temperature increase of approximately 40°C by self heating)
- Operating Temperature Range (including self temperature) : -40°C ~ +165 °c

Note 1 : Circuit design, component placement, PCB trace size and thickness, airflow and other cooling. Provision all affect the part Temperature. Part temperature should be verified in the end application.

▪ **You can also contact us by e-mail : [coilmaster@coilmaster.com](mailto:coilmaster@coilmaster.com)**

- All specifications are subject to change without notice.
- Update date : 2021.12.28

[www.coilmaster.com](http://www.coilmaster.com)

## Packaging

(1) Package quantity : 200 (pcs/reel)

(2) Reel Dimensions (unit:mm)

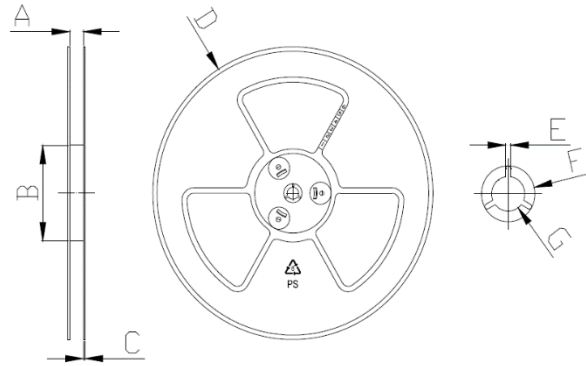

A	B	C	D	E	F	G
32.50	100.0	2.00	330.0	2.30	21.50	13.00
+0.50	+1.00	+0.20	+3.00	+0.30	+0.30	+0.50
-0.50	-1.00	-0.20	-3.00	-0.30	-0.30	-0.20

(3) Tape Dimensions

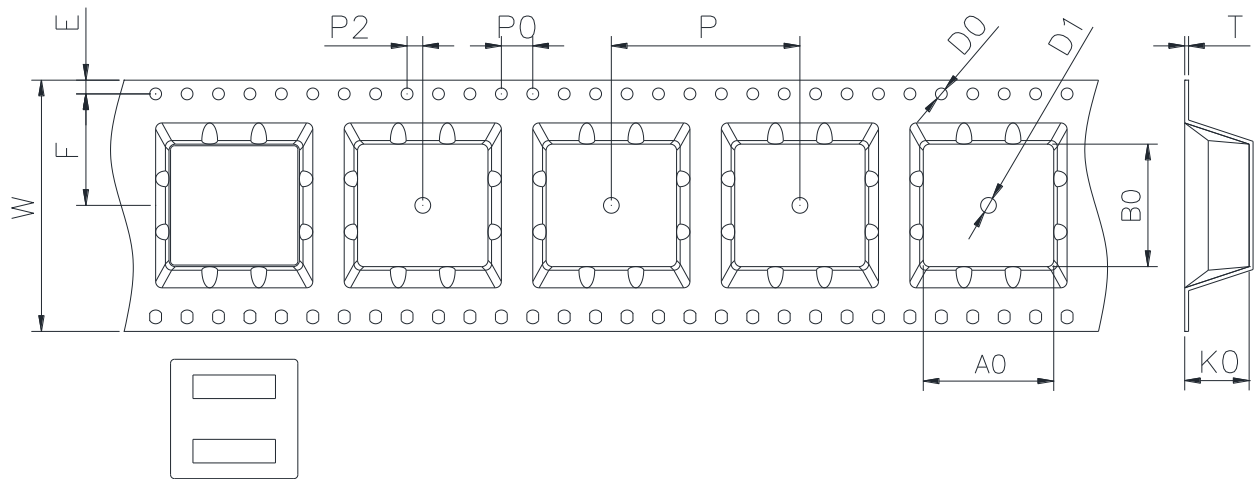

W	A0	B0	K0	E	F	P	P0	P2	D0	D1	T
32.00	16.60	15.60	11.20	1.75	14.20	24.00	4.00	2.00	1.50	2.00	0.50
+0.30	+0.10	+0.10	+0.10	+0.10	+0.10	+0.10	+0.10	+0.10	+0.10	+0.10	+0.05
-0.30	-0.10	-0.10	-0.10	-0.10	-0.10	-0.10	-0.10	-0.10	-0.00	-0.00	-0.05

Korea Sales Office (KOREA) +82)31-904-1444  
 China Sales Office (CHINA) +86)0758-683-1444  
 Hungary Sales office (EUROPE) +36)1-404-5832

H.K Sales Office (HONGKONG) +852)2711-5551  
 LA Sales Office (USA) +1)714-616-6989

• You can also contact us by e-mail : [coilmaster@coilmaster.com](mailto:coilmaster@coilmaster.com)

- All specifications are subject to change without notice.
- Update date : 2021.12.28

[www.coilmaster.com](http://www.coilmaster.com)