

CMI-CMMPP252012MH-SERIES

Features

- ▶ Small size and low profile.
- ▶ Metal powder molding type for EMC protection.
- ▶ Available tape and reel for auto insertion.
- ▶ Halogen-Free.
- ▶ RoHS compliant.
- ▶ AEC-Q200 qualified.

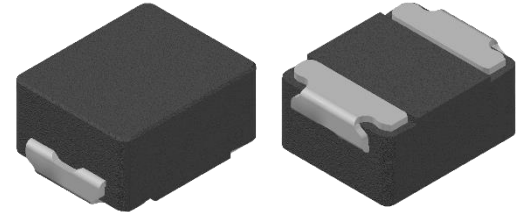

Applications

- ▶ Equipment using for automobiles
(ECM, airbags, headlights, electronic Powder steering, motors, ABS, other)

Dimension (Unit:mm)

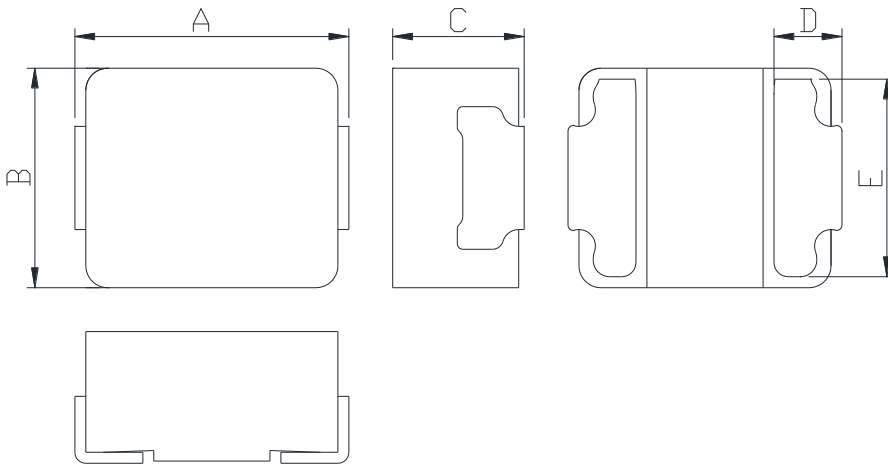

A	B	C	D	E
2.5 ±0.2	2.0 ±0.2	1.2 Max.	0.65 ±0.1	1.8 ±0.3

Land Pattern (Unit:mm)

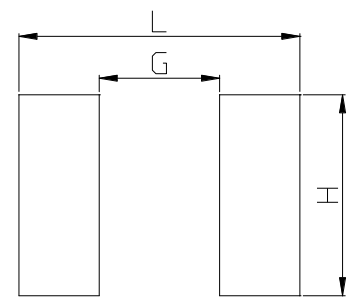

L	G	H
2.80	1.20	2.00

Regulation of part number

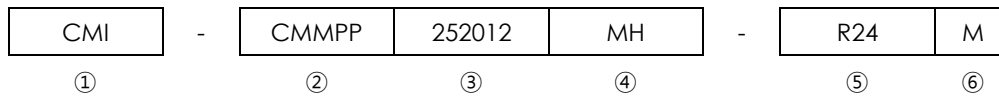

- ① CoilMaster's initial
- ② Series Name : Car Metal Molded Pin type Power inductor
- ③ Series Size (unit:mm)
- ④ Material
- ⑤ Typical inductance value (0.24uH)
- ⑥ Inductance tolerance ($\pm 20\%$)

Specifications

Part Number	Inductance (uH) $\pm 20\%$	DCR(mohm) Max.(Typ.)	Isat(A) Max.(Typ.)	Itemp(A) Max.(Typ.)	Test Frequency (Hz)
CMI-CMMPP252012MH-R24M	0.24	20.4(17)	8.90(9.90)	5.10(5.70)	1M
CMI-CMMPP252012MH-R33M	0.33	21.6(18)	6.60(7.40)	5.00(5.60)	1M
CMI-CMMPP252012MH-R47M	0.47	26.4(22)	5.60(6.20)	4.60(5.10)	1M
CMI-CMMPP252012MH-R68M	0.68	36(30)	4.30(4.80)	3.90(4.30)	1M
CMI-CMMPP252012MH-1R0M	1.0	51.6(43)	3.90(4.40)	3.20(3.60)	1M
CMI-CMMPP252012MH-1R5M	2.2	73.2(61)	3.40(3.80)	2.60(2.90)	1M
CMI-CMMPP252012MH-2R2M	2.2	112(94)	2.80(3.10)	2.10(2.30)	1M
CMI-CMMPP252012MH-3R3M	3.3	147(123)	2.30(2.60)	1.90(2.10)	1M
CMI-CMMPP252012MH-4R7M	4.7	224(187)	1.70(1.90)	1.40(1.60)	1M
CMI-CMMPP252012MH-6R8M	6.8	312(260)	1.60(1.80)	1.25(1.40)	1M
CMI-CMMPP252012MH-R24M	0.24	20.4(17)	8.90(9.90)	5.10(5.70)	1M

- Isat: When based on the inductance change rate (Approximately 30% below in the initial value)
- Itemp: When based on the temperature increase (Temperature increase of approximately 40°C by self heating)
- Operating Temperature Range (including self temperature) : -40°C ~ +165 °c

Note 1 : Circuit design, component placement, PCB trace size and thickness, airflow and other cooling. Provision all affect the part Temperature. Part temperature should be verified in the end application.

▪ **You can also contact us by e-mail : coilmaster@coilmaster.com**

- All specifications are subject to change without notice.
- Update date : 2023.08.10

www.coilmaster.com

Specifications

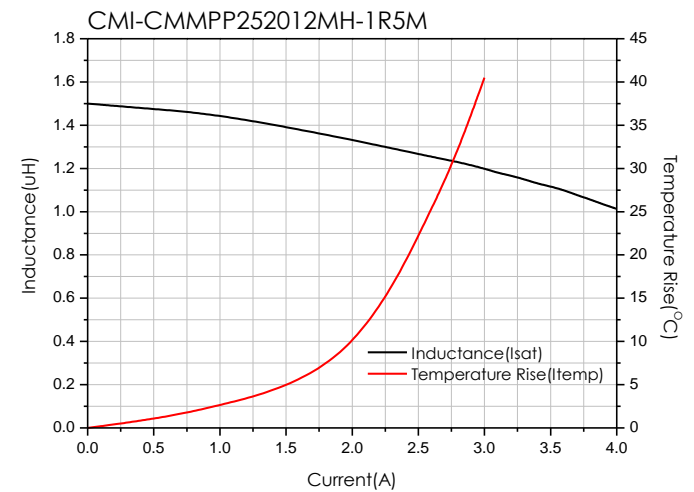
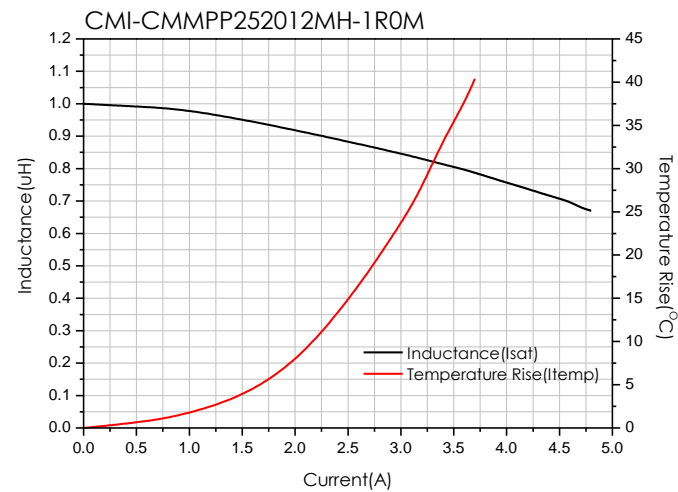
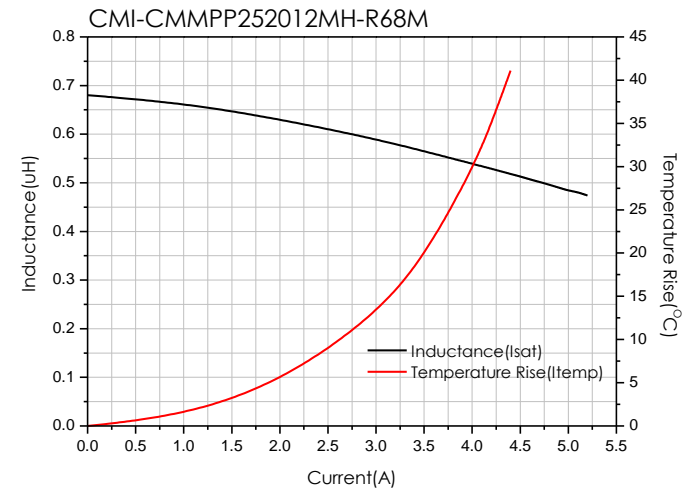
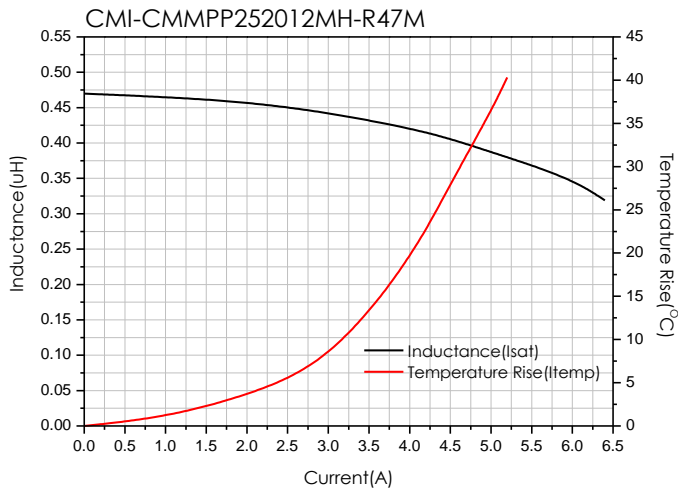
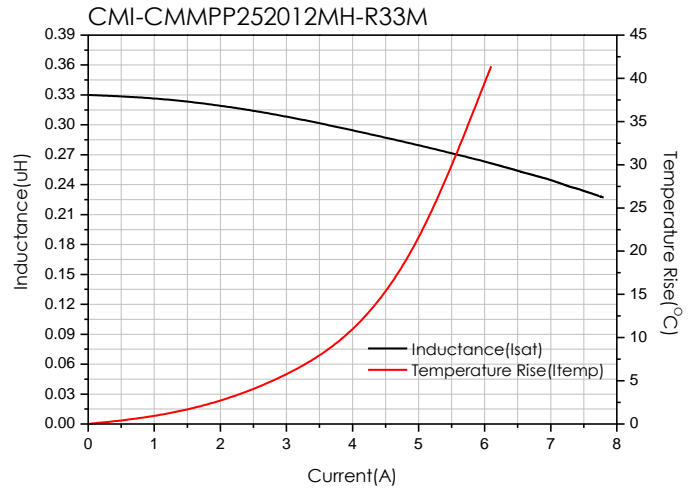
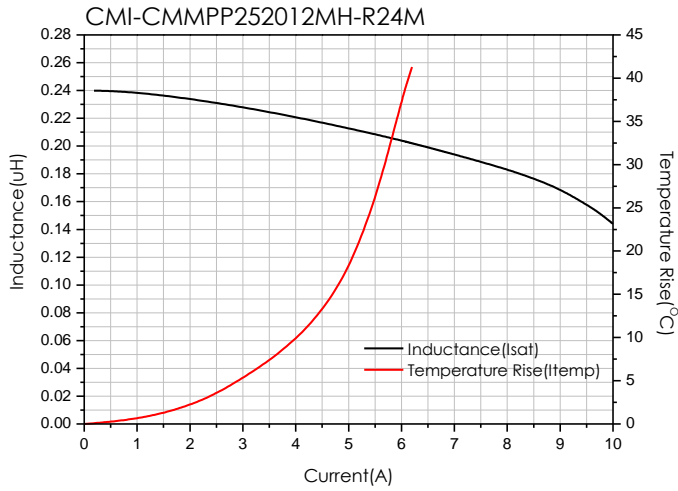

- You can also contact us by e-mail : coilmaster@coilmaster.com
- All specifications are subject to change without notice.
- Update date : 2023.08.10

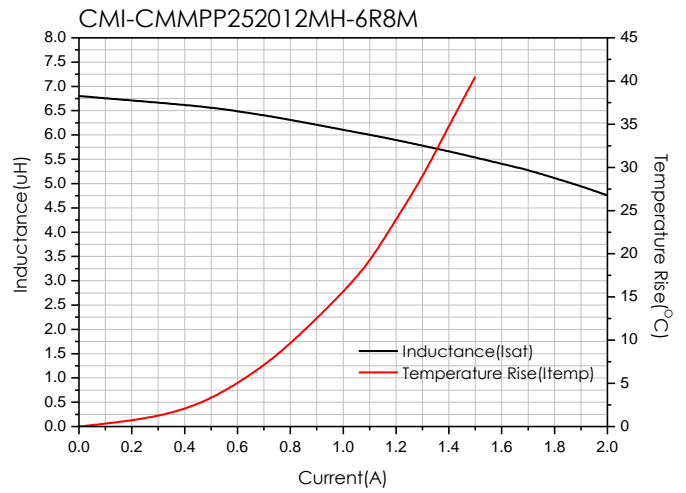
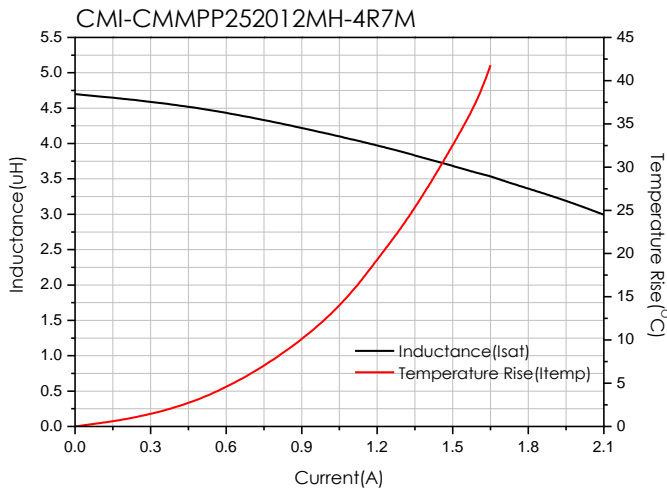
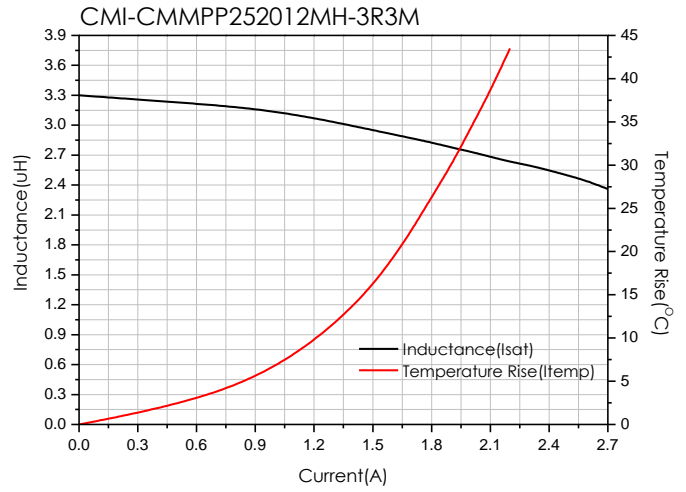
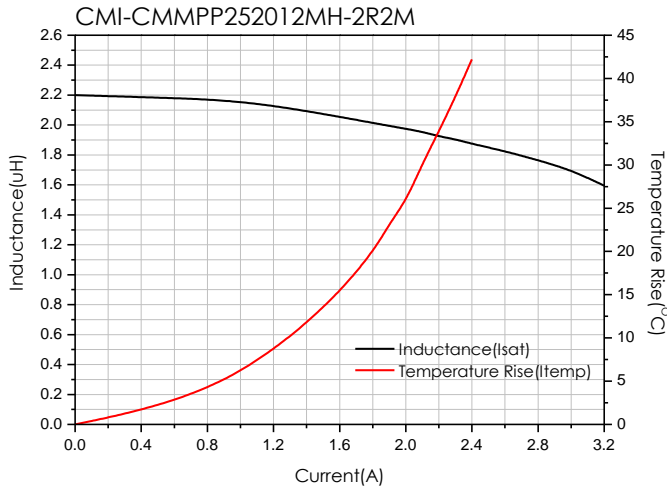

- You can also contact us by e-mail : coilmaster@coilmaster.com
- All specifications are subject to change without notice.
- Update date : 2023.08.10

Packaging

(1) Package quantity : 3,000 (pcs/reel)

(2) Reel Dimensions (unit:mm)

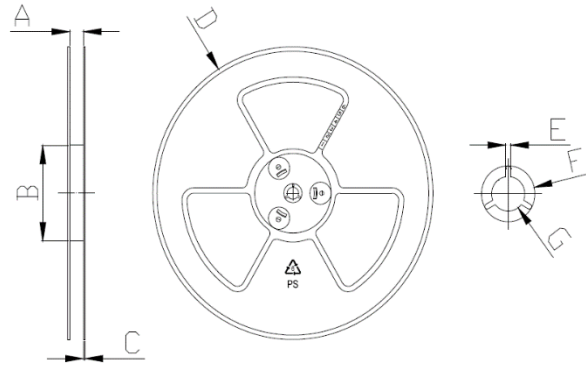

A	B	C	D	E	F	G
8.50	60.0	1.50	178.0	2.70	22.50	13.50
+0.50	+2.00	+0.20	+1.00	+0.30	+0.50	+0.50
-0.50	-2.00	-0.20	-1.00	-0.30	-0.50	-0.50

(3) Tape Dimensions

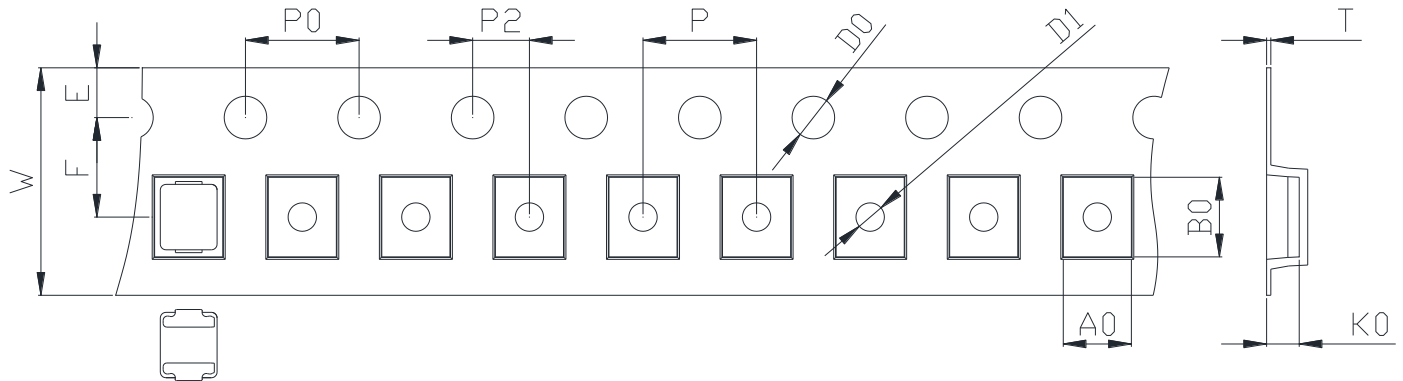

W	A0	B0	K0	E	F	P/P0	P2	D0	D1	T
8.00	2.45	3.05	1.30	1.75	3.50	4.00	2.00	1.50	1.00	0.30
+0.10	+0.05	+0.05	+0.10	+0.15	+0.10	+0.10	+0.05	+0.10	+0.10	+0.05
-0.10	-0.05	-0.05	-0.10	-0.10	-0.10	-0.10	-0.05	-0.00	-0.00	-0.05

Korea Sales Office (KOREA) +82)31-904-1444
 China Sales Office (CHINA) +86)0758-683-1444
 Hungary Sales office (EUROPE) +36)1-404-5832

H.K Sales Office (HONGKONG) +852)2711-5551
 LA Sales Office (USA) +1)714-616-6989

• You can also contact us by e-mail : coilmaster@coilmaster.com

- All specifications are subject to change without notice.
- Update date : 2023.08.10

www.coilmaster.com