

CMI-CMMPP4020HL-SERIES

Features

- ▶ Low profile
- ▶ Metal powder molding type for EMC protection.
- ▶ Available tape and reel for auto insertion.
- ▶ Halogen-Free.
- ▶ RoHS compliant.
- ▶ AEC-Q200 qualified.

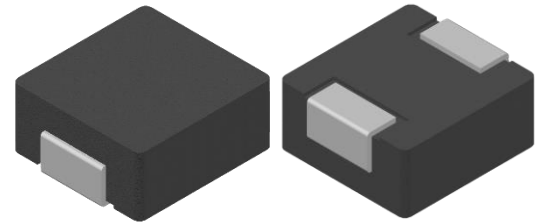

Applications

- ▶ Equipment using for automobiles (ECM, Airbags, Headlights, Electronic Power steering, Motors, ABS, other)

Dimension (Unit:mm)

Land Pattern (Unit:mm)

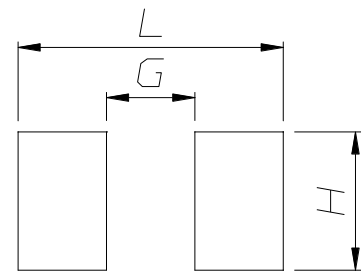
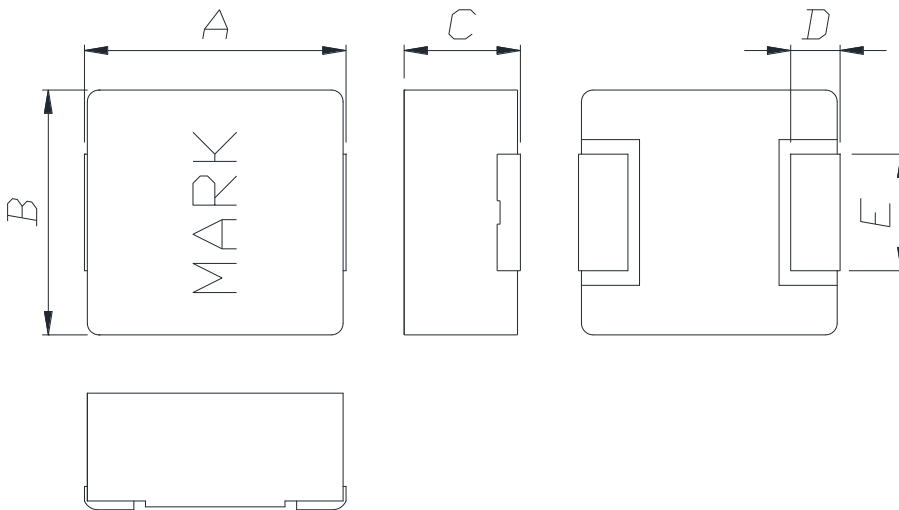

A	B	C	D	E
4.4 ±0.35	4.2 ±0.25	2.0 Max.	0.8 ±0.2	2.0 ±0.2

L	G	H
4.8	1.6	2.5

Regulation of part number

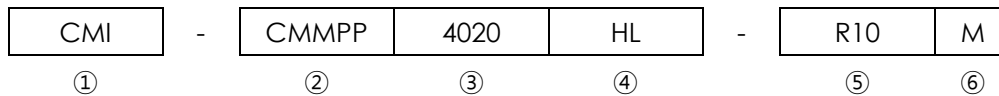

- ① CoilMaster's initial
- ② Series Name : Car Metal Molded Pin type Power inductor
- ③ Core Size (unit:mm)
- ④ Material
- ⑤ Typical inductance value (0.1uH)
- ⑥ Inductance tolerance ($\pm 20\%$)

Specifications

Part Number	Inductance (uH) $\pm 20\%$	DCR(mohm) Max.(Typ.)	Isat(A) Max.(Typ.)	Itemp(A) Max.(Typ.)	Test Frequency (Hz)
CMI-CMMPP4020HL-R10M	0.10	3.6(3.0)	25.00(30.00)	16.00(16.50)	1M
CMI-CMMPP4020HL-R22M	0.22	5.4(4.5)	19.00(22.00)	14.00(15.00)	1M
CMI-CMMPP4020HL-R47M	0.47	17.4(14.5)	10.80(12.00)	7.50(8.00)	1M
CMI-CMMPP4020HL-R68M	0.68	18.6(15.5)	10.50(11.50)	7.00(7.50)	1M
CMI-CMMPP4020HL-1R0M	1.0	30.0(25.0)	10.00(11.00)	5.00(5.50)	1M
CMI-CMMPP4020HL-1R5M	1.5	36.0(30.0)	7.50(8.50)	4.50(5.00)	1M
CMI-CMMPP4020HL-2R2M	2.2	57.6(48.0)	7.00(7.50)	4.00(4.20)	1M
CMI-CMMPP4020HL-3R3M	3.3	72.0(60.0)	5.00(5.50)	3.70(3.90)	1M
CMI-CMMPP4020HL-4R7M	4.7	120(100)	3.20(3.40)	2.80(3.00)	1M
CMI-CMMPP4020HL-6R8M	6.8	144(120)	3.00(3.20)	2.20(2.40)	1M
CMI-CMMPP4020HL-8R2M	8.2	192(160)	2.90(3.10)	2.10(2.30)	1M
CMI-CMMPP4020HL-100M	10	240(200)	2.80(3.00)	1.90(2.10)	1M
CMI-CMMPP4020HL-150M	15	300(250)	2.50(2.80)	1.70(1.90)	1M

- Isat: When based on the inductance change rate (Approximately 30% below in the initial value)
- Itemp: When based on the temperature increase (Temperature increase of approximately 40°C by self heating)
- Operating Temperature Range (including self temperature) : -40°C ~ +165 °c

Note 1 : Circuit design, component placement, PCB trace size and thickness, airflow and other cooling. Provision all affect the part Temperature. Part temperature should be verified in the end application.

▪ **You can also contact us by e-mail : coilmaster@coilmaster.com**

- All specifications are subject to change without notice.
- Update date : 2022.04.27

www.coilmaster.com

Electrical characteristics

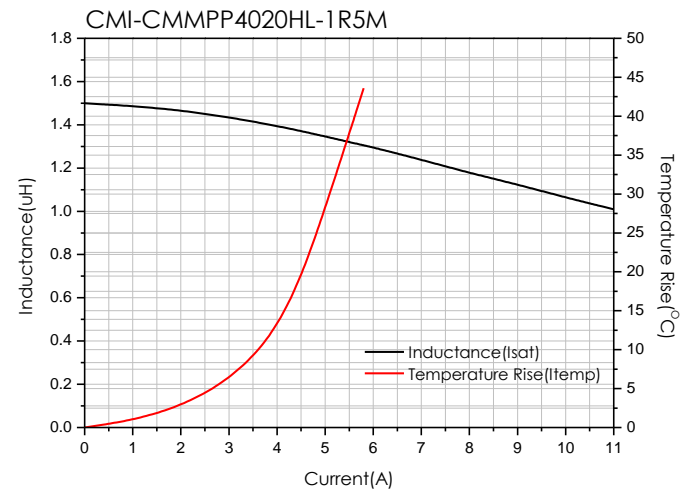
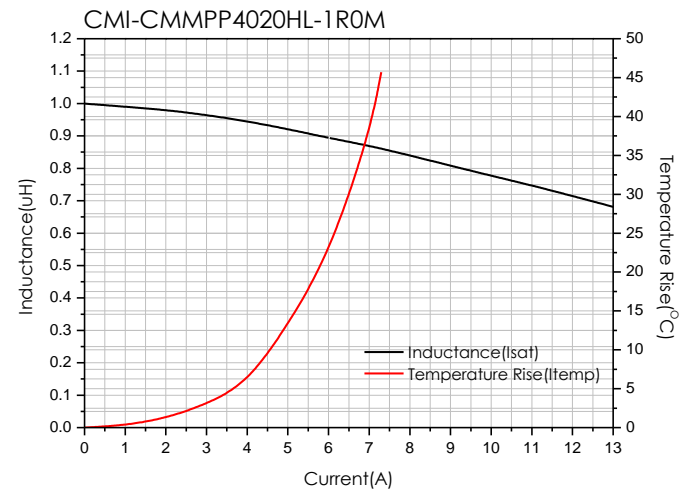
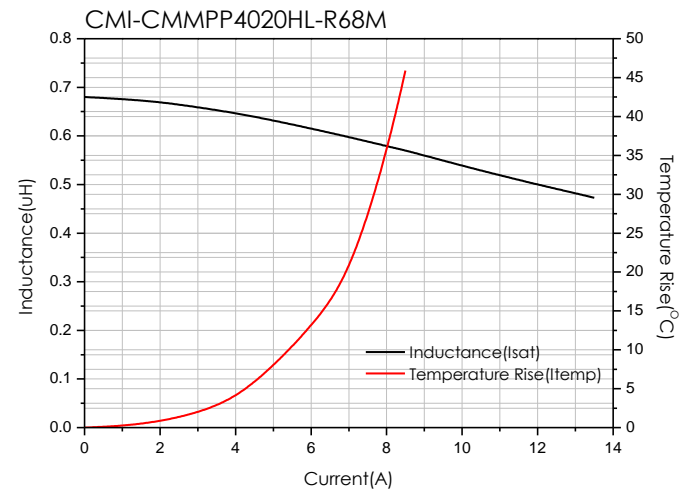
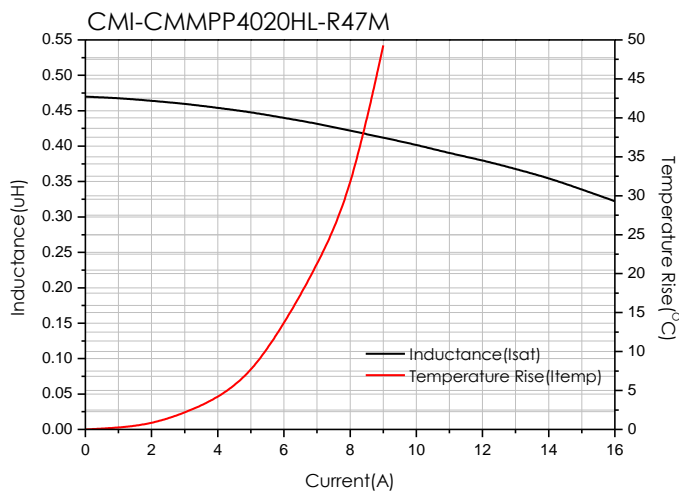
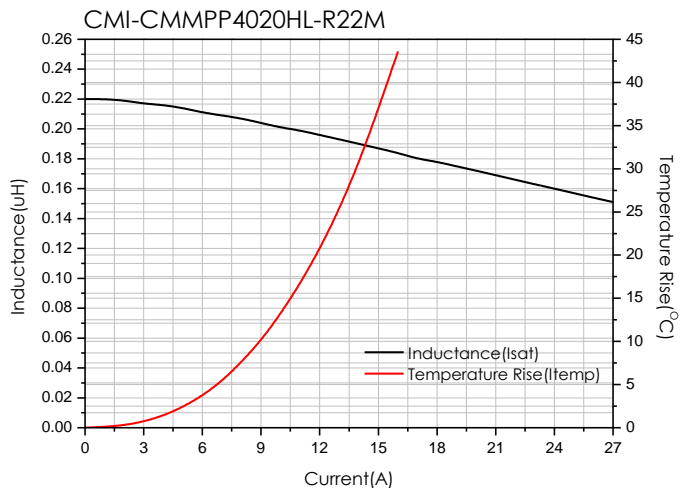
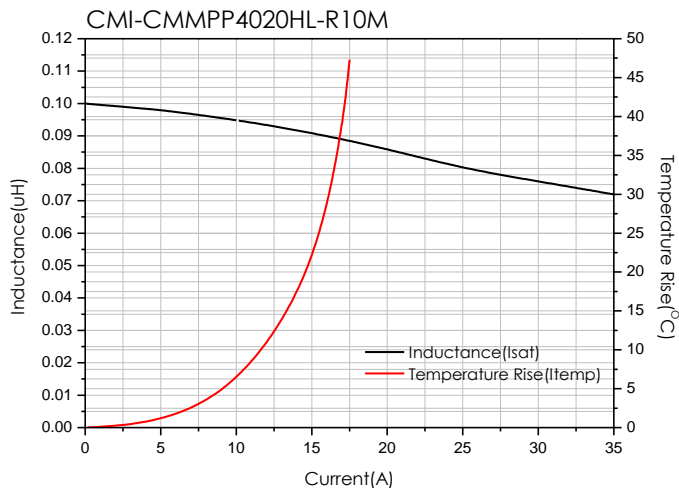

- You can also contact us by e-mail : coilmaster@coilmaster.com
- All specifications are subject to change without notice.
- Update date : 2022.04.27

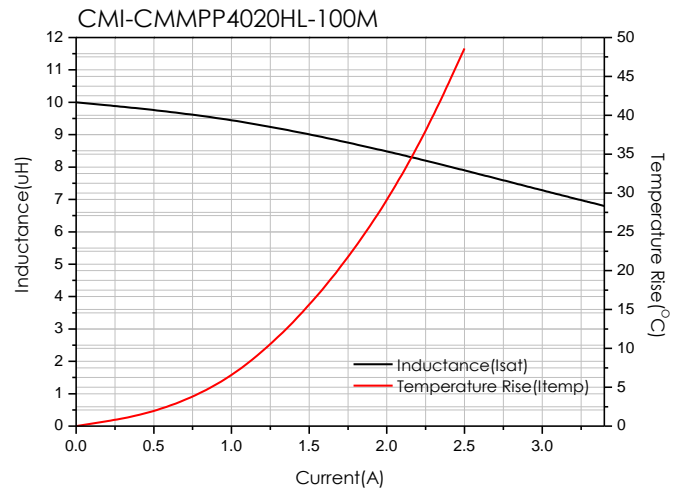
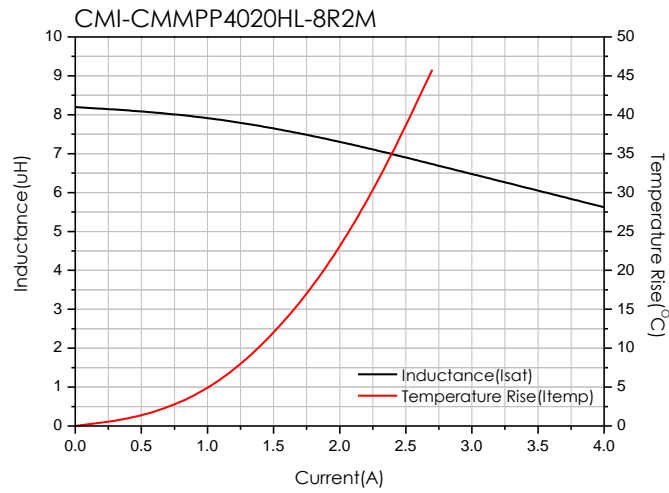
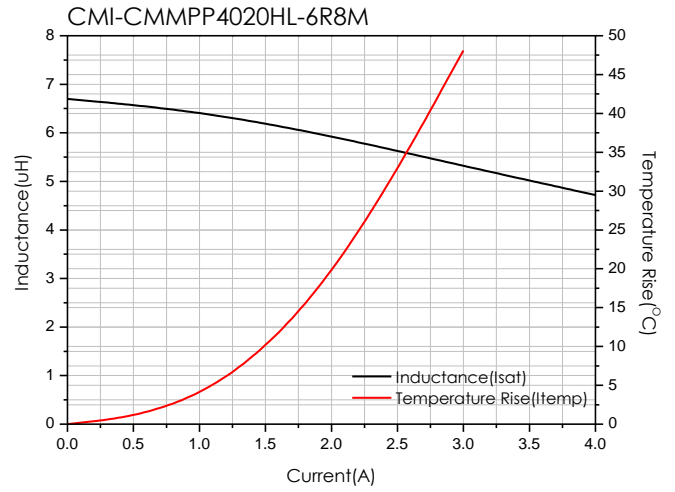
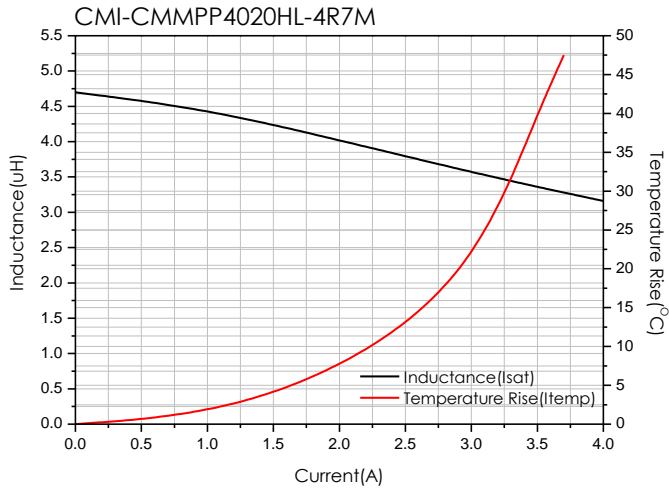
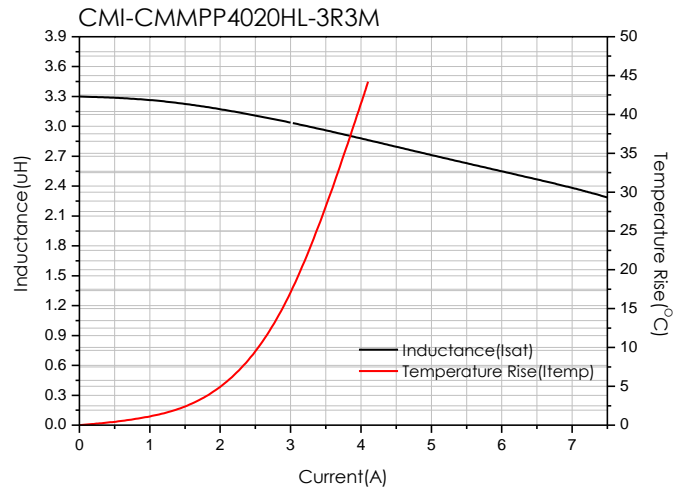
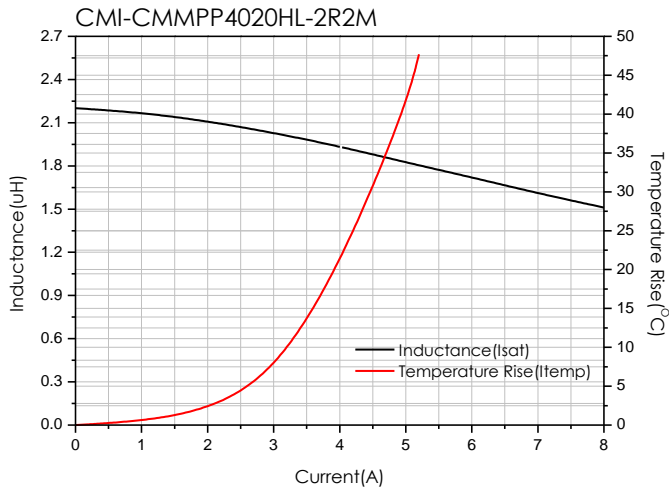

- You can also contact us by e-mail : coilmaster@coilmaster.com
- All specifications are subject to change without notice.
- Update date : 2022.04.27

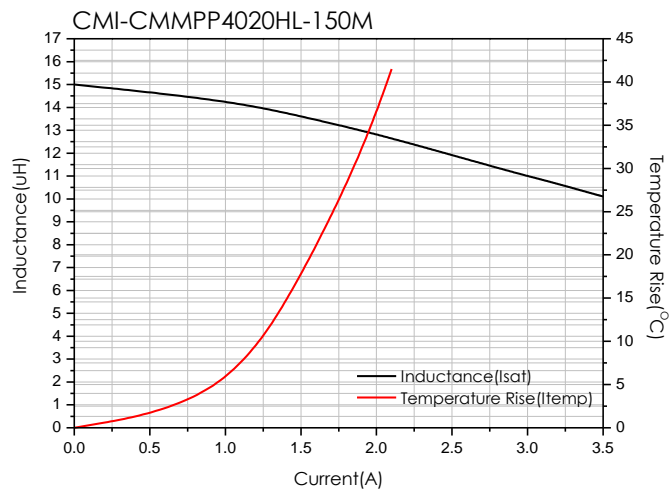

- You can also contact us by e-mail : coilmaster@coilmaster.com
- All specifications are subject to change without notice.
- Update date : 2022.04.27

Packaging

(1) Package quantity : 3,000 (pcs/reel)

(2) Reel Dimensions (unit:mm)

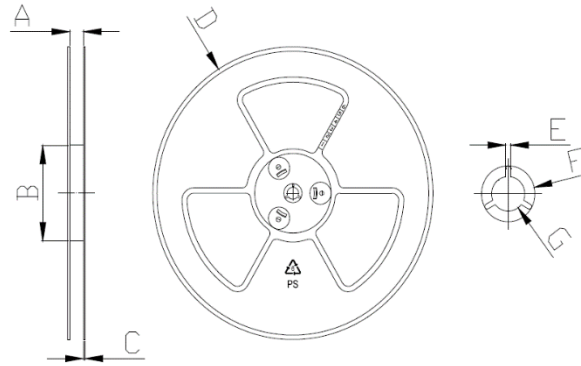

A	B	C	D	E	F	G
12.50	100.0	2.00	330.0	1.90	21.00	13.00
+1.00	+1.50	+0.10	+1.00	+0.40	+0.40	+0.40
-1.00	-1.50	-0.10	-1.00	-0.40	-0.40	-0.40

(3) Tape Dimensions

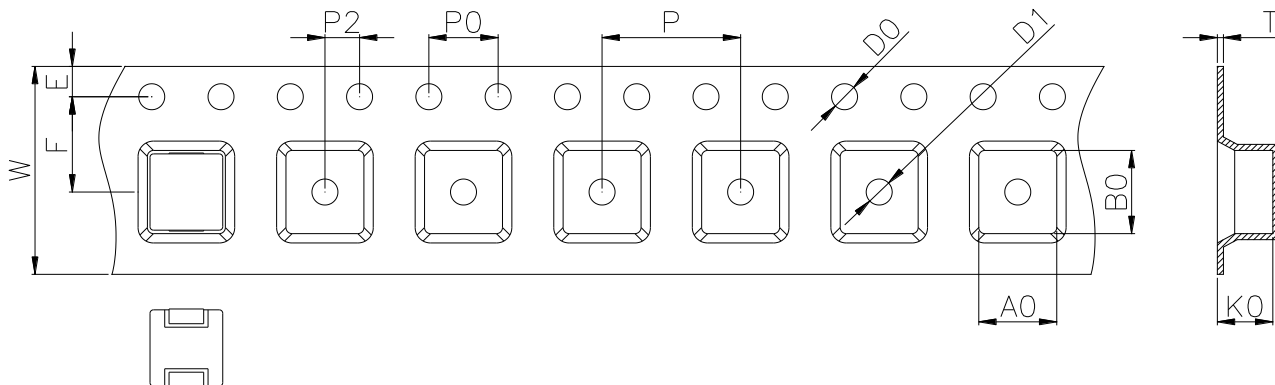

W	A0	B0	K0	E	F	P	P0	P2	D0/D1	T
12.00	4.60	4.90	2.20	1.75	5.50	8.00	4.00	2.00	1.50	0.35
+0.30	+0.10	+0.10	+0.10	+0.10	+0.10	+0.10	+0.10	+0.10	+0.10	+0.05
-0.10	-0.00	-0.00	-0.10	-0.10	-0.10	-0.10	-0.10	-0.10	-0.00	-0.05

Korea Sales Office (KOREA) +82)31-904-1444
 China Sales Office (CHINA) +86)0758-683-1444
 Hungary Sales office (EUROPE) +36)1-404-5832

H.K Sales Office (HONGKONG) +852)2711-5551
 LA Sales Office (USA) +1)714-616-6989

• You can also contact us by e-mail : coilmaster@coilmaster.com

- All specifications are subject to change without notice.
- Update date : 2022.04.27

www.coilmaster.com