

CMI-CMMPP6015HL-N SERIES

Features

- ▶ Low profile
- ▶ Metal powder molding type for EMC protection.
- ▶ Available tape and reel for auto insertion.
- ▶ Halogen-Free.
- ▶ RoHS compliant.
- ▶ AEC-Q200 qualified.

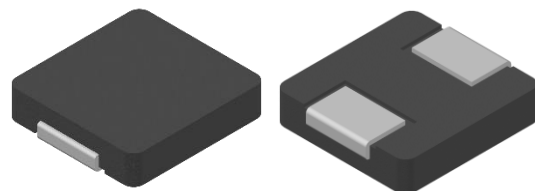

Applications

- ▶ Equipment using for automobiles (ECM, Airbags, Headlights, Electronic Power steering, Motors, ABS, other)

Dimension (Unit:mm)

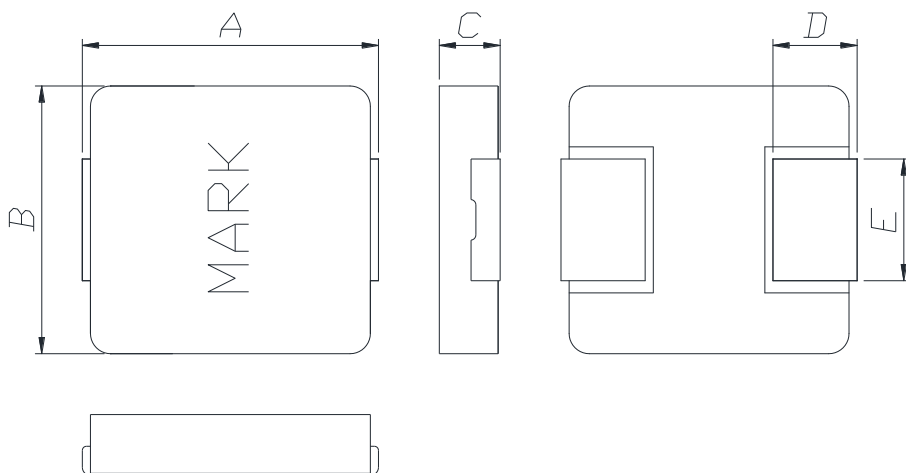

A	B	C	D	E
6.95 ±0.45	6.6 ±0.25	1.5 Max.	1.8 ±0.3	3.0 ±0.3

Land Pattern (Unit:mm)

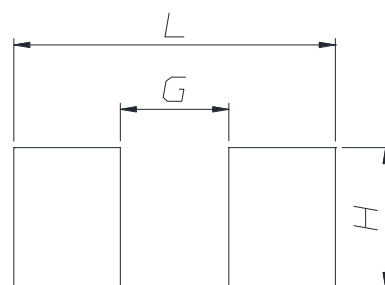

L	G	H
8.0	2.7	3.5

Regulation of part number

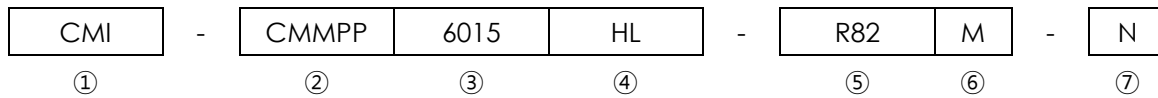

- ① CoilMaster's initial
- ② Series Name : Car Metal Molded Pin type Power inductor
- ③ Core Size (unit:mm)
- ④ Material
- ⑤ Typical inductance value (0.82uH)
- ⑥ Inductance tolerance (±20%)
- ⑦ Revision (N)

Specifications

Part Number	Inductance (uH) ±20%	DCR(mohm) Max.(Typ.)	Isat(A) Max.(Typ.)	Itemp(A) Max.(Typ.)	Test Frequency (Hz)
CMI-CMMPP6015HL-R82M-N	0.82	14.4(12)	11.0(12.0)	9.0(9.5)	1M
CMI-CMMPP6015HL-1R0M-N	1.0	19.2(16)	10.5(11.5)	8.8(9.3)	1M
CMI-CMMPP6015HL-1R5M-N	1.5	25(21)	9.0(10.0)	8.5(9.0)	1M
CMI-CMMPP6015HL-2R2M-N	2.2	42(35)	7.5(8.5)	7.0(8.0)	1M
CMI-CMMPP6015HL-3R3M-N	3.3	66(55)	5.0(5.5)	4.5(5.0)	1M
CMI-CMMPP6015HL-4R7M-N	4.7	96(80)	4.5(5.0)	3.2(3.4)	1M
CMI-CMMPP6015HL-6R8M-N	6.8	144(120)	3.8(4.3)	2.8(3.0)	1M
CMI-CMMPP6015HL-100M-N	10	228(190)	3.5(4.0)	2.2(2.4)	1M

- Isat: When based on the inductance change rate (Approximately 30% below in the initial value)
- Itemp: When based on the temperature increase (Temperature increase of approximately 40°C by self heating)
- Operating Temperature Range (including self temperature) : -40°C ~ +165 °c

Note 1 : Circuit design, component placement, PCB trace size and thickness, airflow and other cooling. Provision all affect the part Temperature. Part temperature should be verified in the end application.

▪ **You can also contact us by e-mail : coilmaster@coilmaster.com**

- All specifications are subject to change without notice.
- Update date : 2023.03.01

www.coilmaster.com

Electrical characteristics

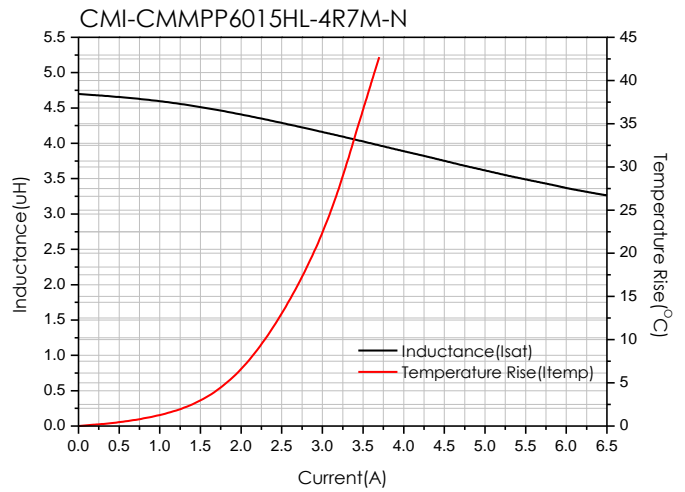
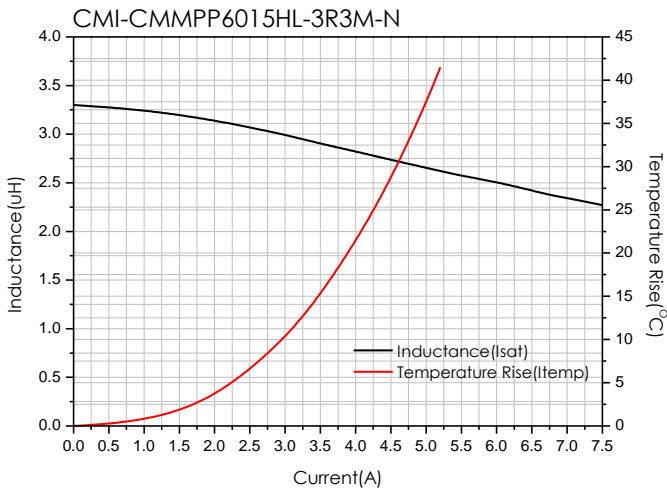
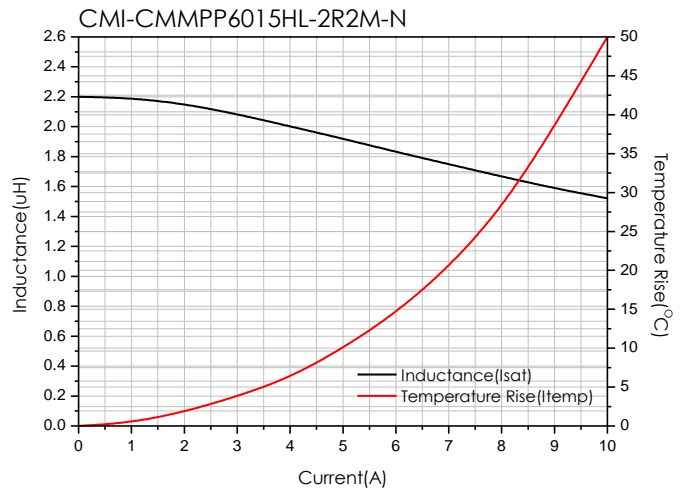
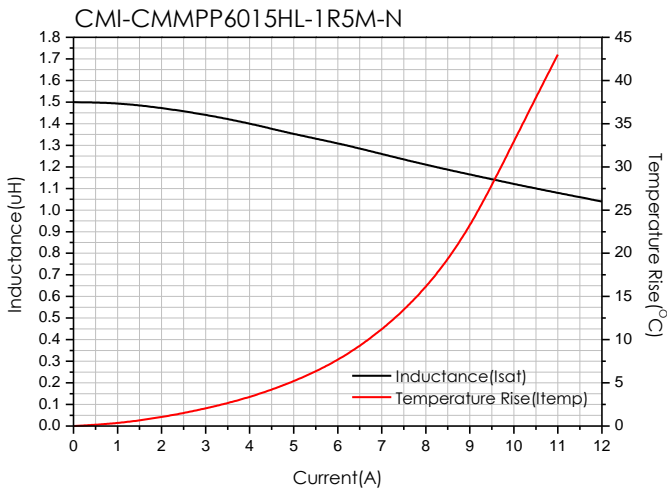
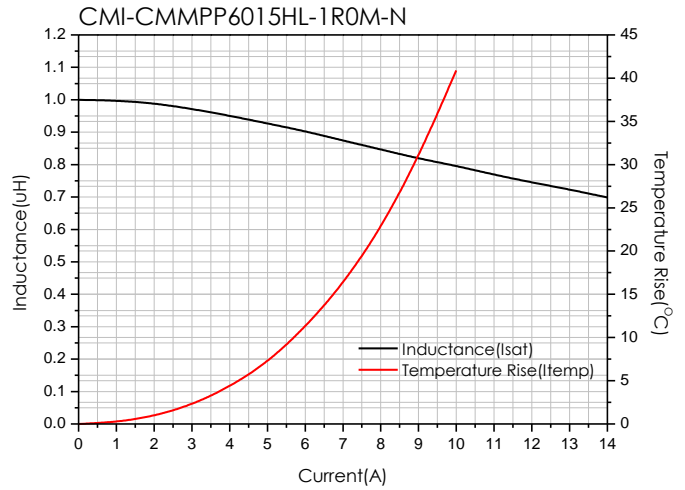
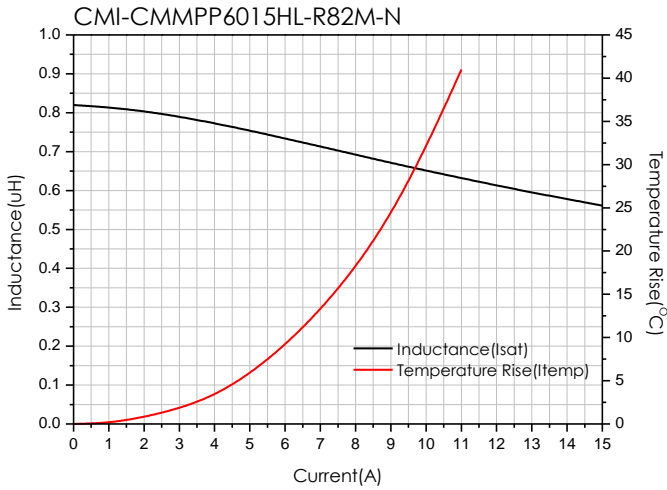

- You can also contact us by e-mail : coilmaster@coilmaster.com
- All specifications are subject to change without notice.
- Update date : 2023.03.01

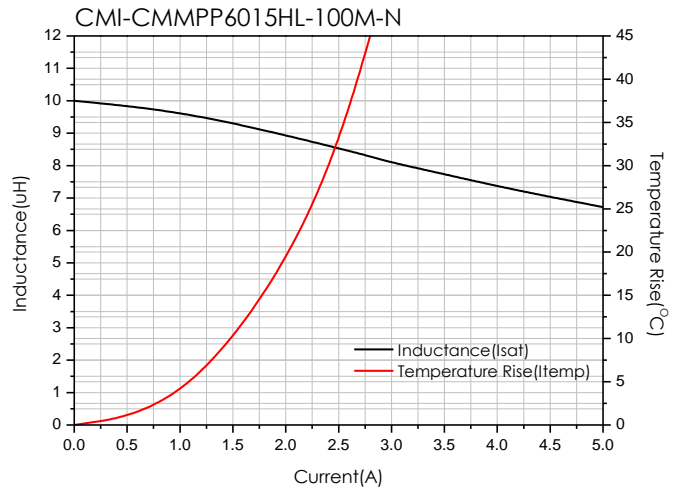
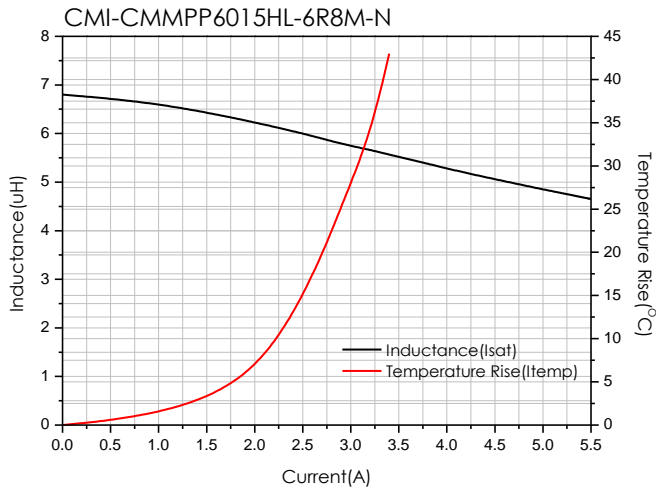

- You can also contact us by e-mail : coilmaster@coilmaster.com
- All specifications are subject to change without notice.
- Update date : 2023.03.01

Packaging

(1) Package quantity : 3,000 (pcs/reel)

(2) Reel Dimensions (unit:mm)

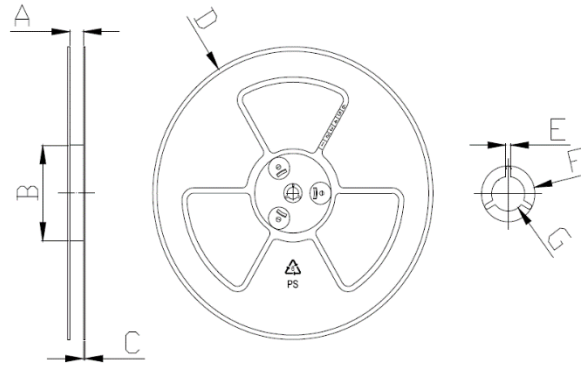

A	B	C	D	E	F	G
16.50	100.0	2.00	330.0	2.30	21.50	13.00
+0.50	+1.00	+0.10	+3.00	+0.30	+0.30	+0.50
-0.50	-1.00	-0.10	-3.00	-0.30	-0.30	-0.20

(3) Tape Dimensions

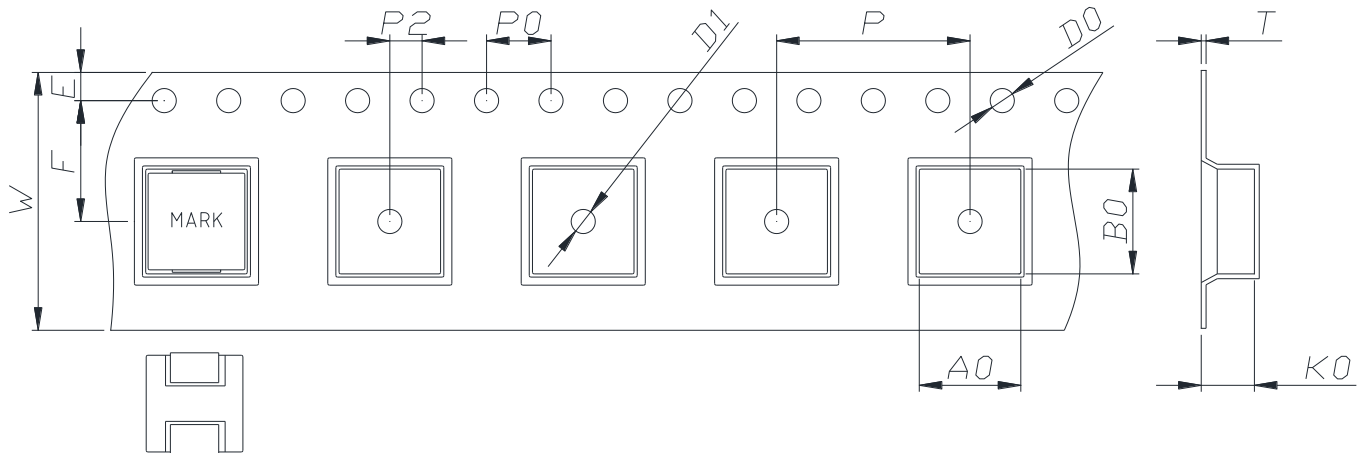

W	A0	B0	K0	E	F	P	P0	P2	D0/D1	T
16.00	7.00	7.50	1.70	1.75	7.50	12.00	4.00	2.00	1.50	0.30
+0.30	+0.10	+0.10	+0.10	+0.10	+0.10	+0.10	+0.10	+0.10	+0.10	+0.05
-0.10	-0.10	-0.10	-0.10	-0.10	-0.10	-0.10	-0.10	-0.10	-0.00	-0.05

Korea Sales Office (KOREA) +82)31-904-1444
 China Sales Office (CHINA) +86)0758-683-1444
 Hungary Sales office (EUROPE) +36)1-404-5832

H.K Sales Office (HONGKONG) +852)2711-5551
 LA Sales Office (USA) +1)714-616-6989

• You can also contact us by e-mail : coilmaster@coilmaster.com

- All specifications are subject to change without notice.
- Update date : 2023.03.01

www.coilmaster.com