

CMI-CMMPP6050HL-N SERIES

Features

- ▶ Metal powder molding type for EMC protection.
- ▶ Available tape and reel for auto insertion.
- ▶ Halogen-Free.
- ▶ RoHS compliant.
- ▶ AEC-Q200 qualified.

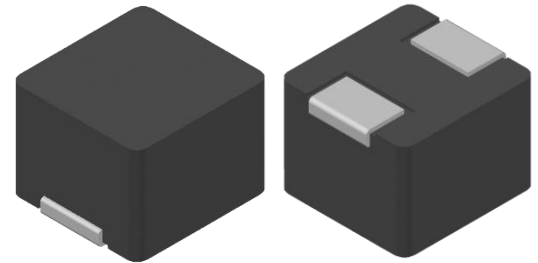

Applications

- ▶ Equipment using for automobiles (ECM, Airbags, Headlights, Electronic Power steering, Motors, ABS, other)

Dimension (Unit:mm)

Land Pattern (Unit:mm)

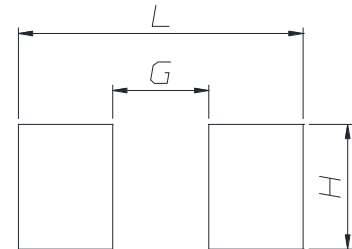
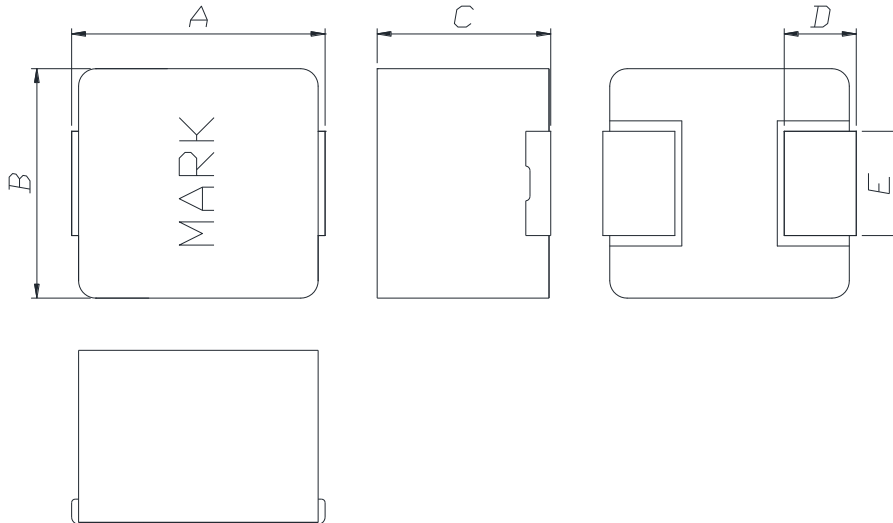

A	B	C	D	E
6.95 ±0.45	6.6 ±0.25	5.0 Max.	1.8 ±0.3	3.0 ±0.3

L	G	H
8.0	2.7	3.5

Regulation of part number

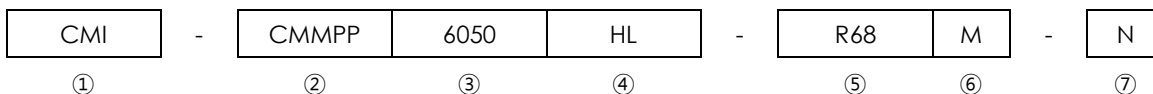

- ① CoilMaster's initial
- ② Series Name : Car Metal Molded Pin type Power inductor
- ③ Core Size (unit:mm)
- ④ Material
- ⑤ Typical inductance value (0.68uH)
- ⑥ Inductance tolerance (±20%)
- ⑦ Revision (N)

Specifications

Part Number	Inductance (uH) ±20%	DCR(mohm) Max.(Typ.)	Isat(A) Max.(Typ.)	Itemp(A) Max.(Typ.)	Test Frequency (Hz)
CMI-CMMPP6050HL-R68M-N	0.68	4.8(4)	22.0(27.0)	14.2(14.7)	1M
CMI-CMMPP6050HL-R82M-N	0.82	7.2(6)	21.0(26.0)	14.0(14.5)	1M
CMI-CMMPP6050HL-3R3M-N	3.3	15(12.5)	11.0(13.0)	10.0(12.0)	1M
CMI-CMMPP6050HL-4R7M-N	4.7	21(17.5)	10.5(12.5)	9.5(10.5)	1M
CMI-CMMPP6050HL-6R8M-N	6.8	31.2(26)	10.0(12.0)	6.5(7.0)	1M
CMI-CMMPP6050HL-100M-N	10	54(45)	7.5(8.5)	6.0(6.5)	1M
CMI-CMMPP6050HL-680M-N	68	312(260)	2.2(2.5)	2.3(2.5)	1M

- Isat: When based on the inductance change rate (approximately 30% below in the initial value)
- Itemp: When based on the temperature increase (Temperature increase of approximately 40°C by self heating)
- Operating Temperature Range(including self temperature) : -40°C ~ +165 °c

Note 1 : Circuit design, component placement, PCB trace size and thickness, airflow and other cooling. Provision all affect the part Temperature. Part temperature should be verified in the end application.

▪ **You can also contact us by e-mail : coilmaster@coilmaster.com**

- All specifications are subject to change without notice.
- Update date : 2023.09.12

www.coilmaster.com

Electrical characteristics

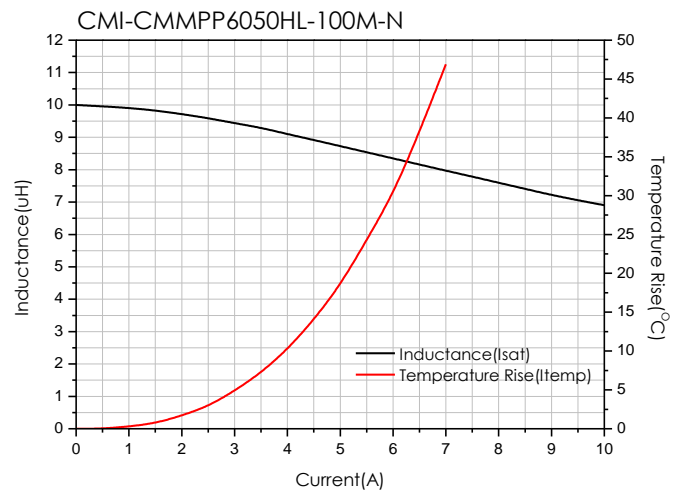
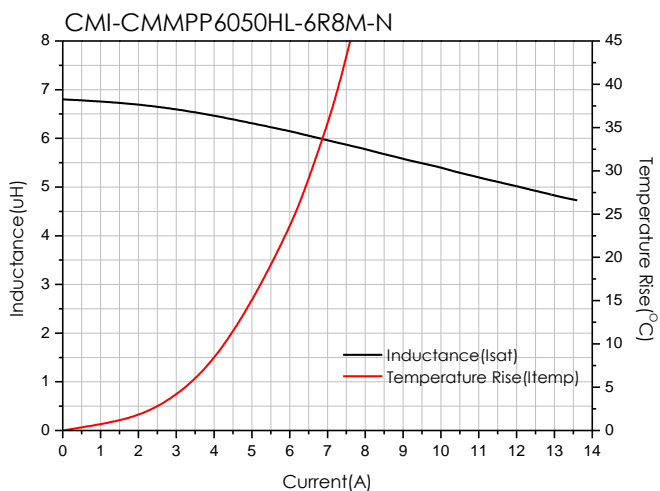
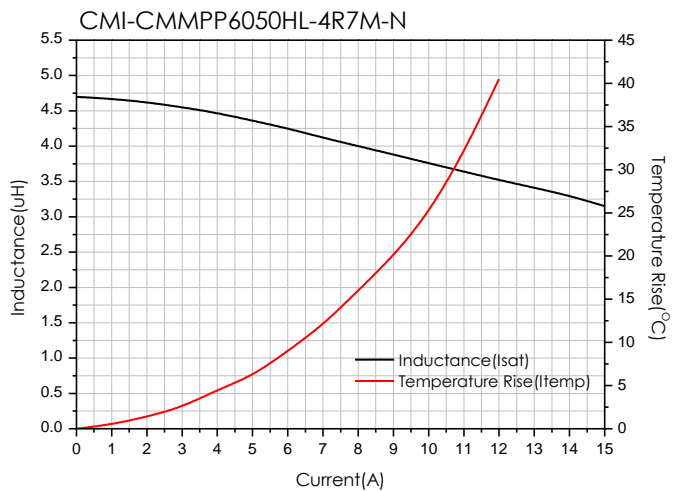
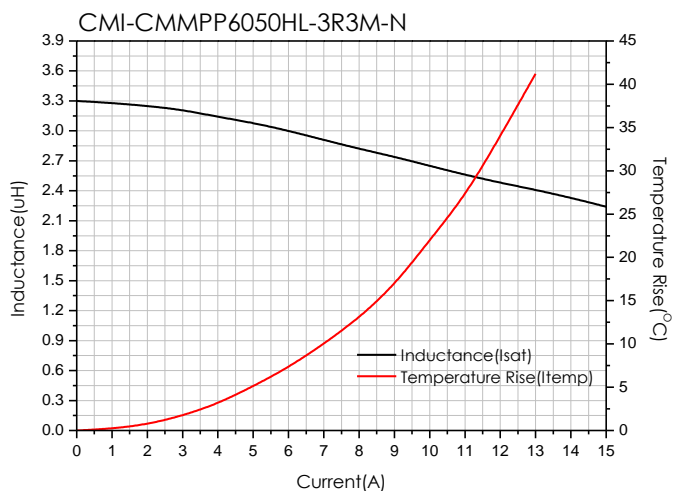
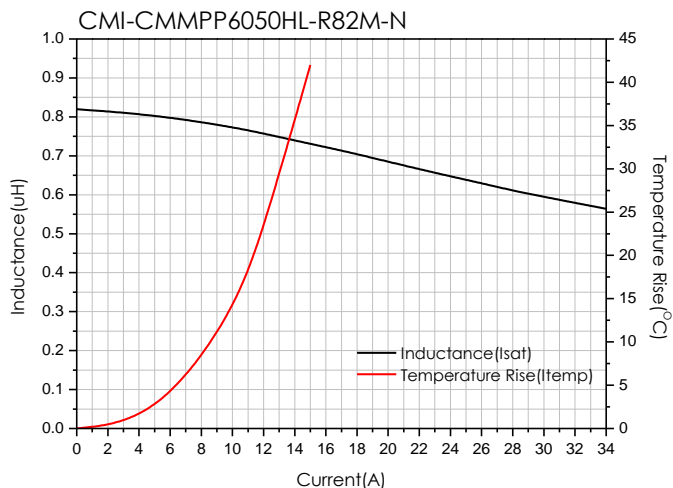
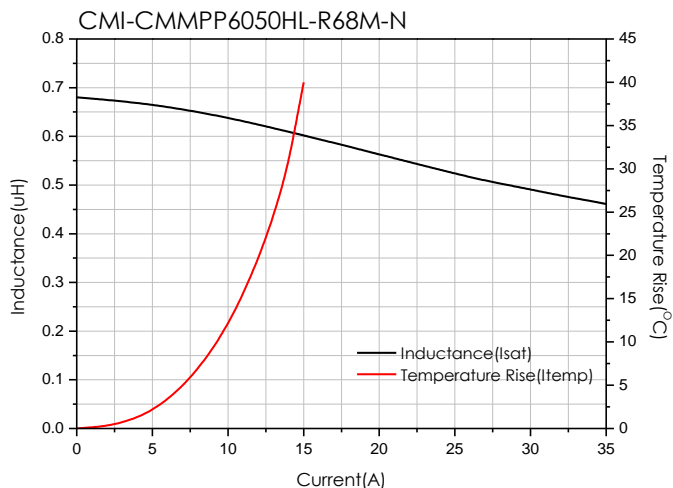

- You can also contact us by e-mail : coilmaster@coilmaster.com
- All specifications are subject to change without notice.
- Update date : 2023.09.12

CMI-CMMPP6050HL-680M-N

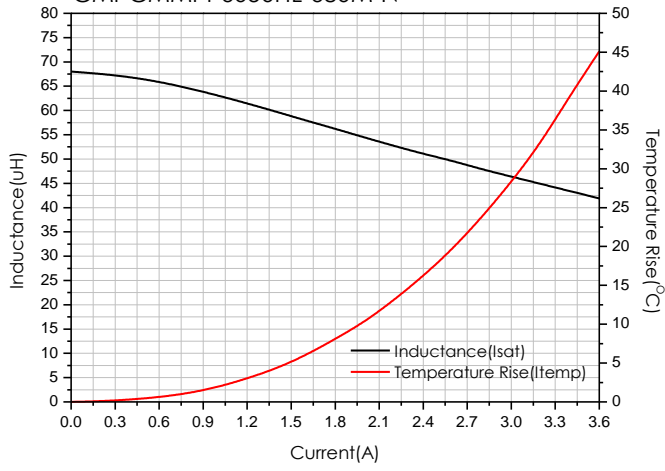

- You can also contact us by e-mail : coilmaster@coilmaster.com
- All specifications are subject to change without notice.
- Update date : 2023.09.12

Packaging

(1) Package quantity : 700 (pcs/reel)

(2) Reel Dimensions (unit:mm)

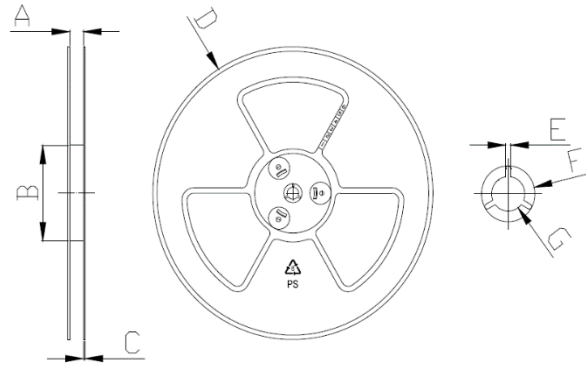

A	B	C	D	E	F	G
16.50	100.0	2.00	330.0	1.90	21.00	13.00
+1.00	+1.50	+0.10	+1.00	+0.40	+0.40	+0.40
-1.00	-1.50	-0.10	-1.00	-0.40	-0.40	-0.40

(3) Tape Dimensions

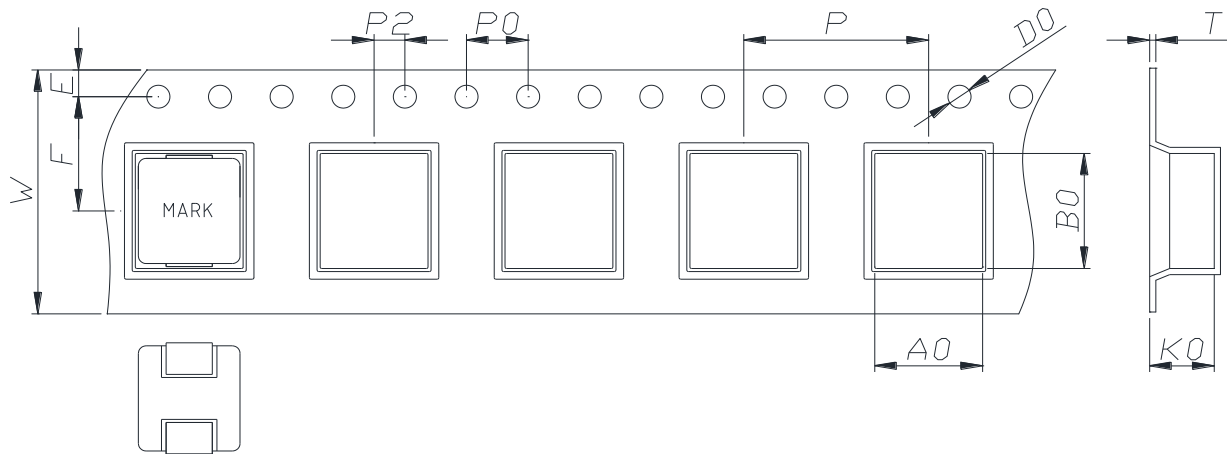

W	A0	B0	K0	E	F	P	P0	P2	D0	T
16.00	7.00	7.60	5.40	1.75	7.50	12.00	4.00	2.00	1.50	0.40
+0.30	+0.10	+0.10	+0.10	+0.10	+0.10	+0.10	+0.10	+0.10	+0.10	+0.05
-0.10	-0.00	-0.10	-0.10	-0.10	-0.10	-0.10	-0.10	-0.10	-0.00	-0.05

Korea Sales Office (KOREA) +82)31-904-1444
 China Sales Office (CHINA) +86)0758-683-1444
 Hungary Sales office (EUROPE) +36)1-404-5832

H.K Sales Office (HONGKONG) +852)2711-5551
 LA Sales Office (USA) +1)714-616-6989

• You can also contact us by e-mail : coilmaster@coilmaster.com

- All specifications are subject to change without notice.
- Update date : 2023.09.12

www.coilmaster.com