

# CMI-MMP4030HL-SERIES

## Features

- ▶ Compact design.
- ▶ Metal powder molding type for EMC protection.
- ▶ Available tape and reel for auto insertion.
- ▶ Halogen-Free
- ▶ RoHS compliant.

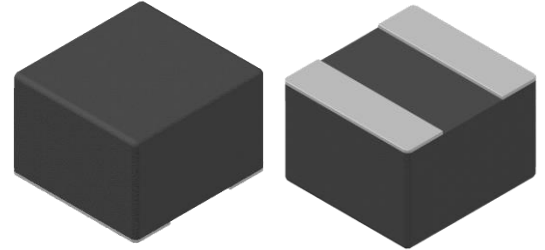

## Applications

- ▶ For DC/DC converter, AV equipment digital consumer electronics

## Dimension (Unit:mm)

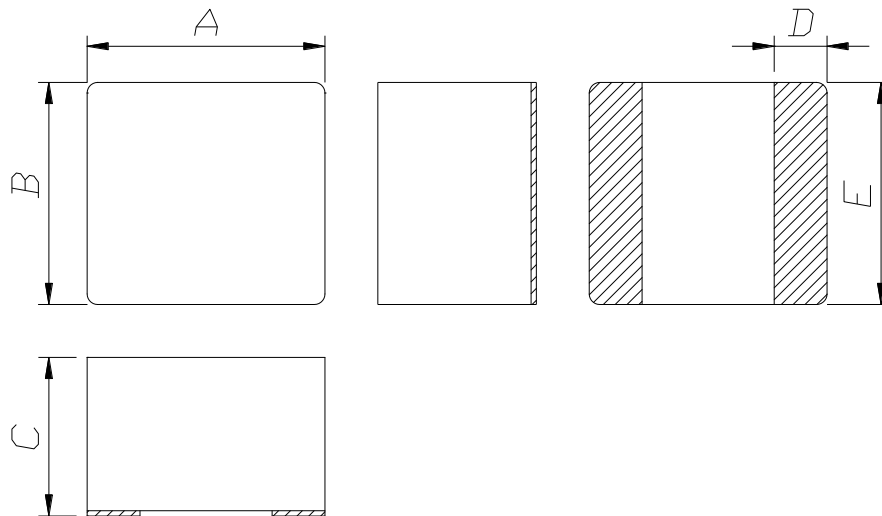

A	B	C	D	E
4.5 ±0.3	4.2 ±0.3	3.0 Max.	1.0 ±0.3	4.2 ±0.3

## Land Pattern (Unit:mm)

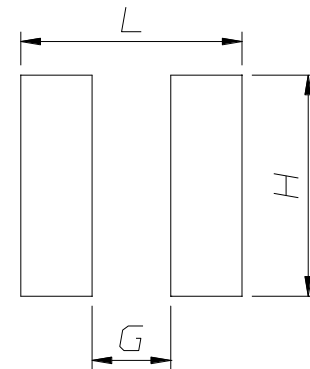

L	G	H
4.5	1.6	4.3

## Regulation of part number

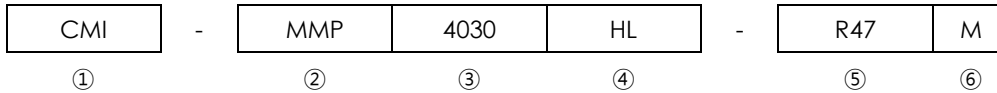

- ① CoilMaster's initial
- ② Series Name : Metal Molded Power inductor
- ③ Core Size (unit:mm)
- ④ Type
- ⑤ Typical inductance value (0.47uH)
- ⑥ Inductance tolerance ( $\pm 20\%$ )

## Specifications

Part Number	Inductance (uH) $\pm 20\%$	DCR(mohm) Max.(Typ.)	Isat(A) Max.(Typ.)	Itemp(A) Max.(Typ.)	Test Frequency (Hz)
CMI-MMP4030HL-R47M	0.47	10(8.5)	15.0(17.0)	8.4(9.4)	1M
CMI-MMP4030HL-1R0M	1.0	16.8(14)	10.5(12.5)	7.0(8.0)	1M
CMI-MMP4030HL-1R8M	1.8	24(20)	8.0(9.0)	6.4(6.9)	1M
CMI-MMP4030HL-2R2M	2.2	30(25)	7.1(8.1)	5.3(5.8)	1M
CMI-MMP4030HL-2R7M	2.7	36(30)	6.8(7.8)	5.2(5.7)	1M
CMI-MMP4030HL-3R3M	3.3	42(35)	6.6(7.3)	4.9(5.4)	1M
CMI-MMP4030HL-4R7M	4.7	60(50)	5.0(5.5)	4.1(4.5)	1M
CMI-MMP4030HL-6R8M	6.8	78(65)	4.5(5.0)	3.8(4.2)	1M
CMI-MMP4030HL-8R2M	8.2	102(85)	4.2(4.7)	3.2(3.5)	1M
CMI-MMP4030HL-100M	10	138(115)	4.0(4.4)	2.8(3.1)	1M
CMI-MMP4030HL-220M	22	252(210)	2.9(3.3)	1.8(2.0)	1M

Isat: When based on the inductance change rate (Approximately 30% below in the initial value)

- Itemp: When based on the temperature increase (Temperature increase of approximately 40°C by self heating)
- Operating Temperature Range (including self temperature) : -40°C ~ +125 °c

Note 1 : Circuit design, component placement, PCB trace size and thickness, airflow and other cooling. Provision all affect the part Temperature. Part temperature should be verified in the end application.

▪ **You can also contact us by e-mail : [coilmaster@coilmaster.com](mailto:coilmaster@coilmaster.com)**

- All specifications are subject to change without notice.
- Update date : 2023.11.24

[www.coilmaster.com](http://www.coilmaster.com)

## Electrical characteristics

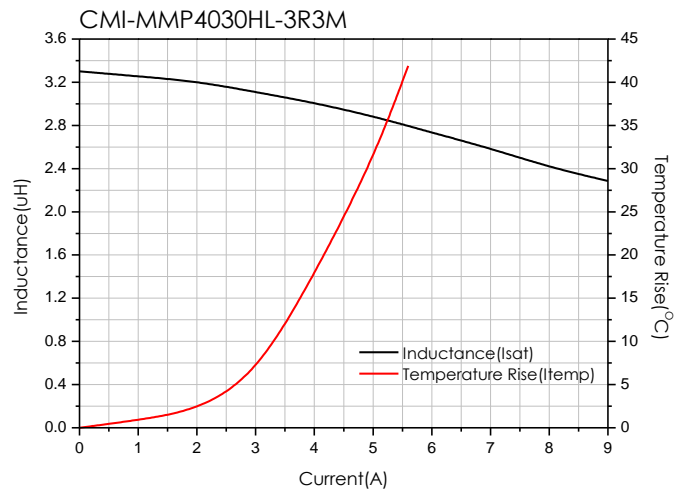
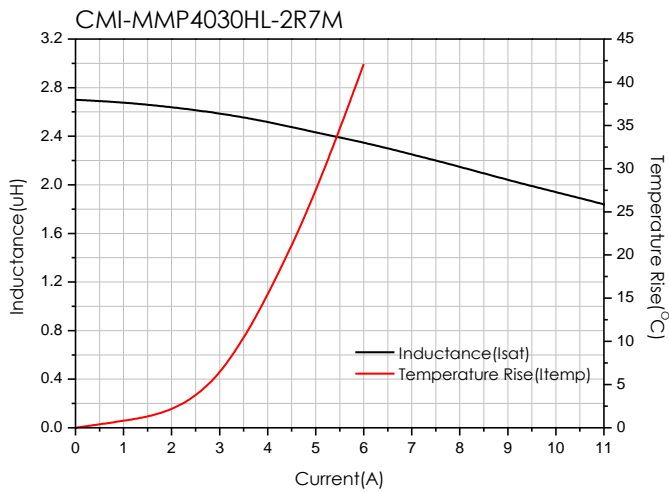
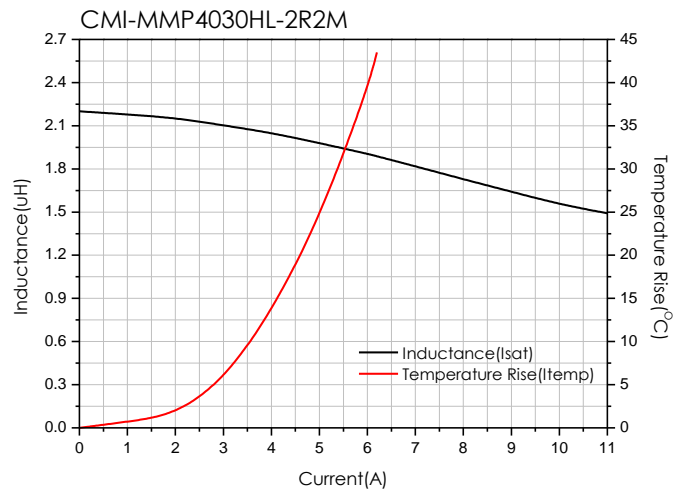
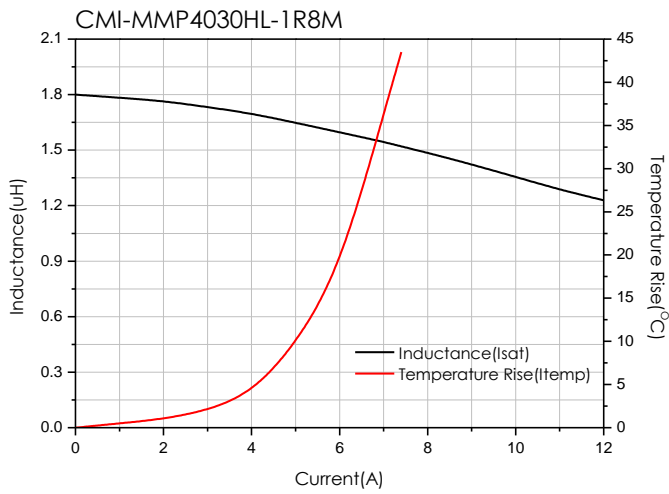
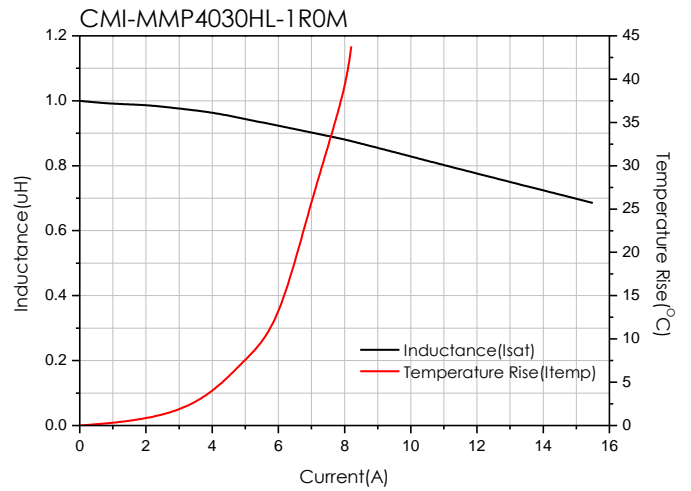
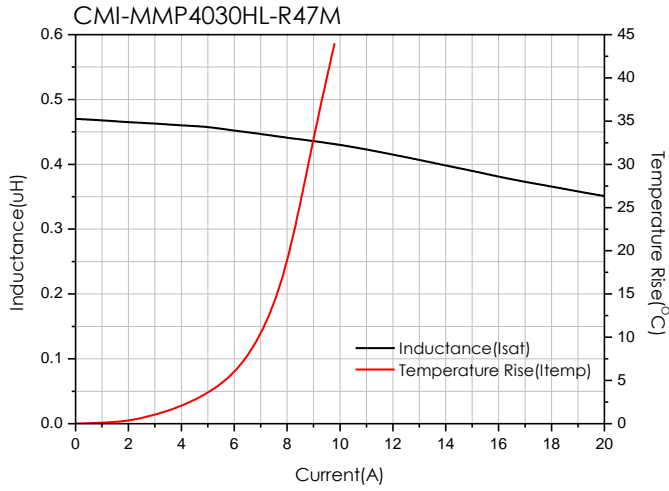

- You can also contact us by e-mail : [coilmaster@coilmaster.com](mailto:coilmaster@coilmaster.com)
- All specifications are subject to change without notice.
- Update date : 2023.11.24

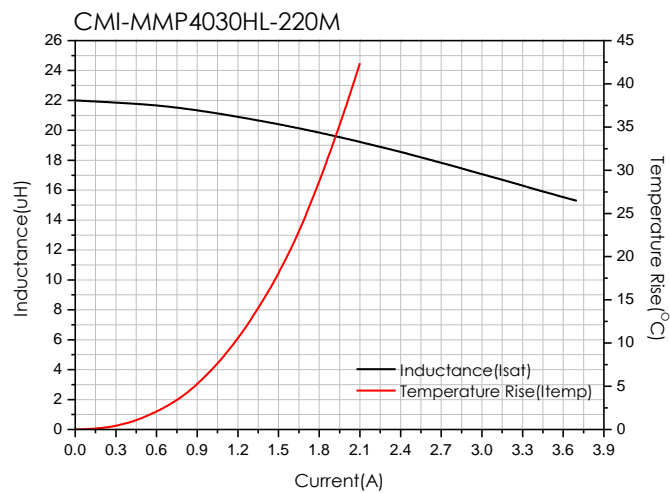
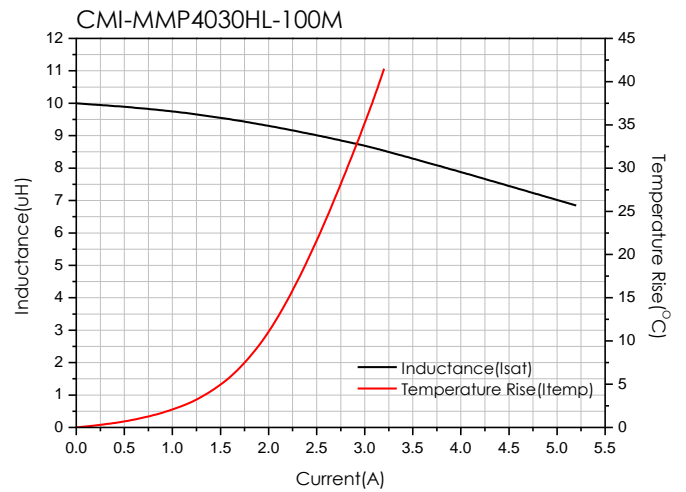
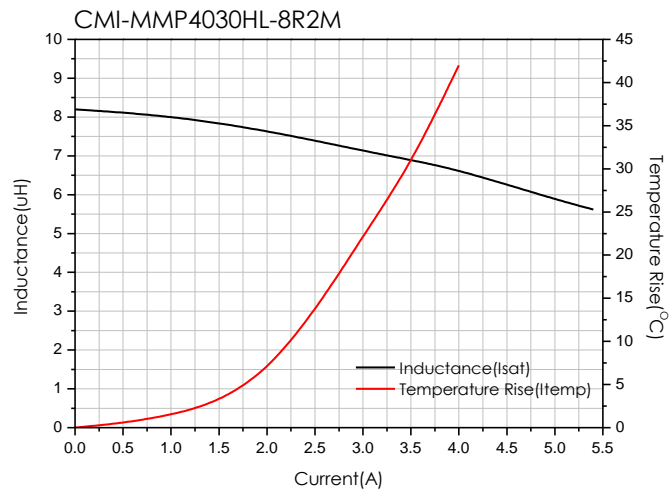
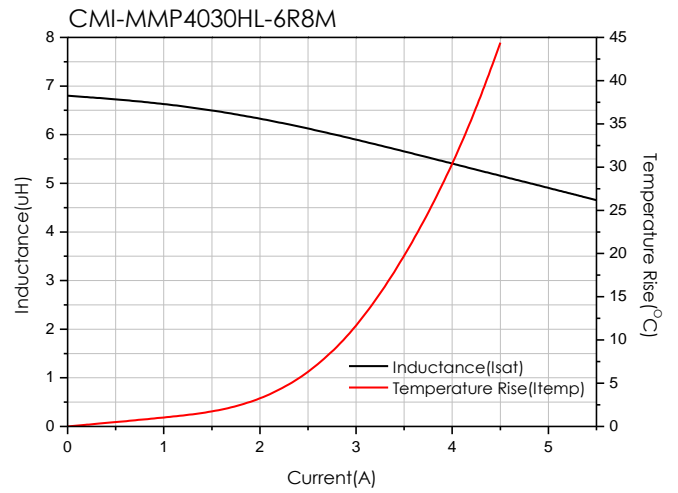
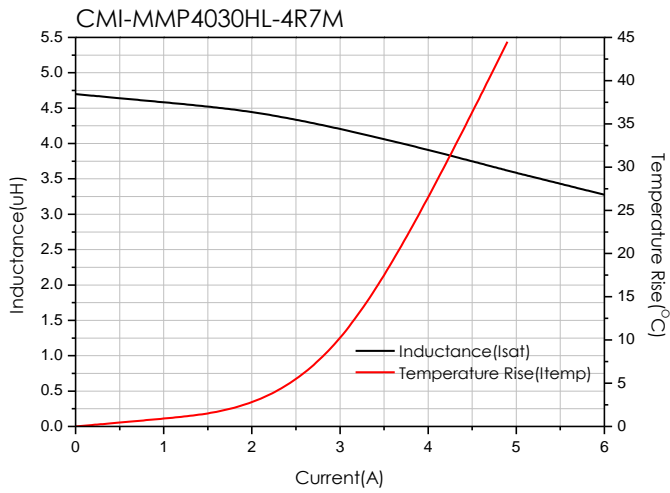

- You can also contact us by e-mail : [coilmaster@coilmaster.com](mailto:coilmaster@coilmaster.com)
- All specifications are subject to change without notice.
- Update date : 2023.11.24

## Packaging

(1) Package quantity : 2,000 (pcs/reel)

(2) Reel Dimensions (unit:mm)

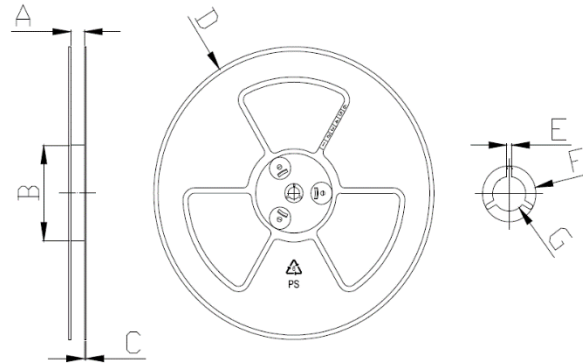

A	B	C	D	E	F	G
12.50	100.0	2.00	330.0	1.90	21.00	13.00
+1.00	+1.50	+0.10	+1.00	+0.40	+0.40	+0.40
-1.00	-1.50	-0.10	-1.00	-0.40	-0.40	-0.40

(3) Tape Dimensions

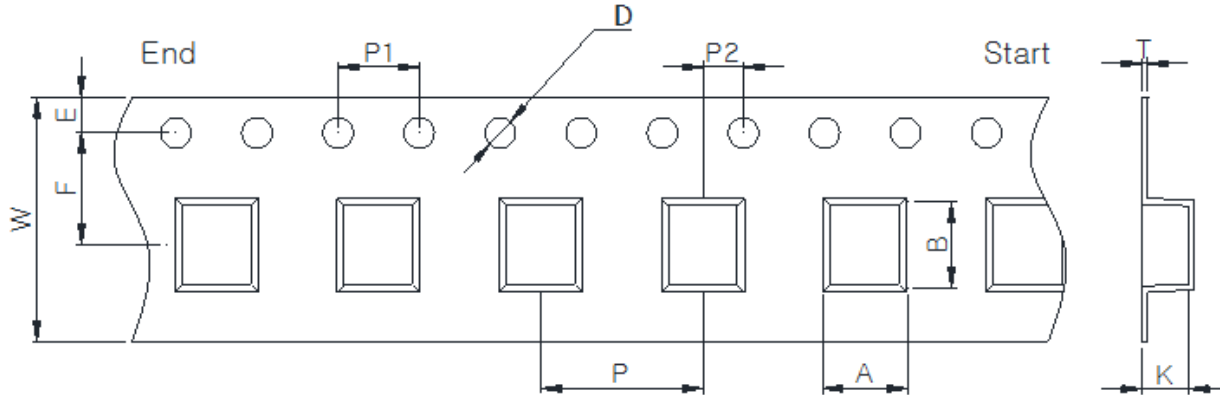

W	A	B	K	E	F	P	P1	P2	D	T
12.00	4.50	4.80	3.20	1.75	5.50	8.00	4.00	2.00	1.50	0.35
+0.30	+0.10	+0.10	+0.10	+0.15	+0.10	+0.10	+0.10	+0.10	+0.10	+0.05
-0.10	-0.10	-0.10	-0.10	-0.10	-0.10	-0.10	-0.10	-0.10	-0.00	-0.05

Korea Sales Office (KOREA) +82)31-904-1444  
 China Sales Office (CHINA) +86)0758-683-1444  
 Hungary Sales office (EUROPE) +36)1-404-5832

H.K Sales Office (HONGKONG) +852)2711-5551  
 LA Sales Office (USA) +1)714-616-6989

• You can also contact us by e-mail : [coilmaster@coilmaster.com](mailto:coilmaster@coilmaster.com)

- All specifications are subject to change without notice.
- Update date : 2023.11.24

[www.coilmaster.com](http://www.coilmaster.com)