

# CMI-MMPF13030H2-SB SERIES

## Features

- ▶ Low AC Loss.
- ▶ Metal powder molding type for EMC protection.
- ▶ Lower DCR with applying flat wire.
- ▶ Halogen-Free.
- ▶ RoHS compliant.

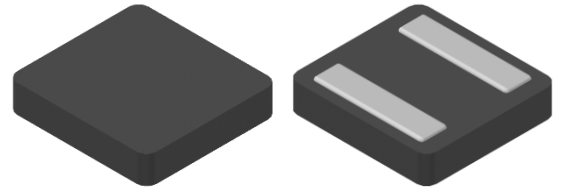

## Applications

- ▶ For DC/DC converter. (Notebook, Table PC, etc.)

## Dimension (Unit:mm)

## Land Pattern (Unit:mm)

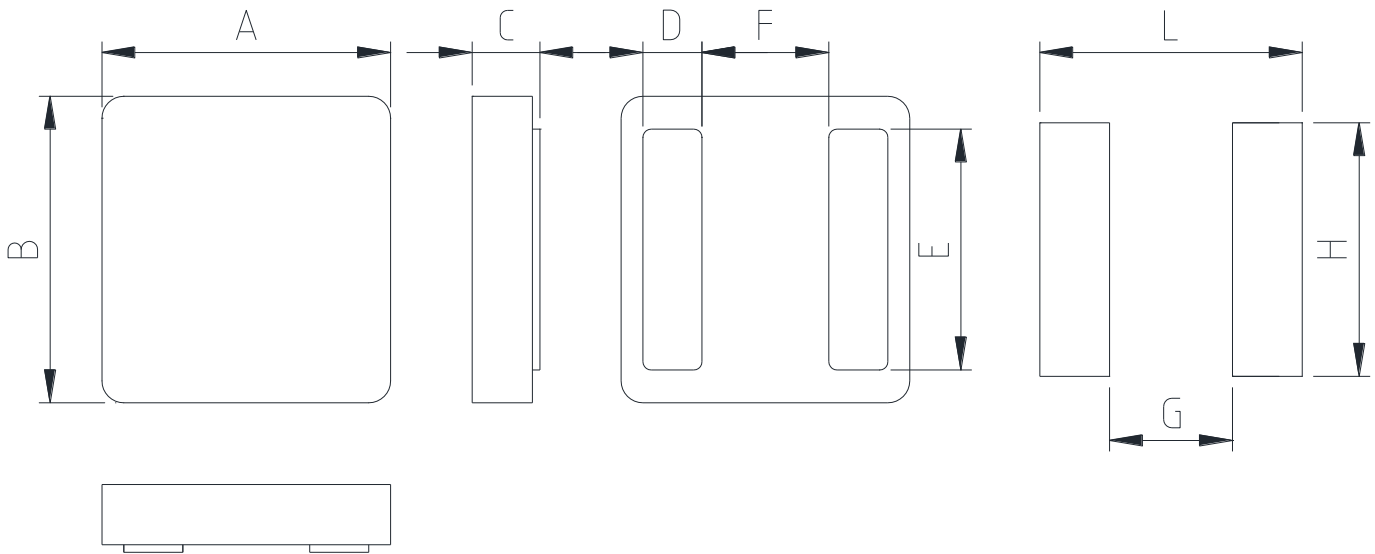

A	B	C	D	E	F	G	H	L
13.2 ±0.5	14.0 ±0.5	3.1 Max.	2.7 ±0.2	11.0 Typ.	5.8 Typ.	11.68	12.00	5.60



# Electrical characteristics

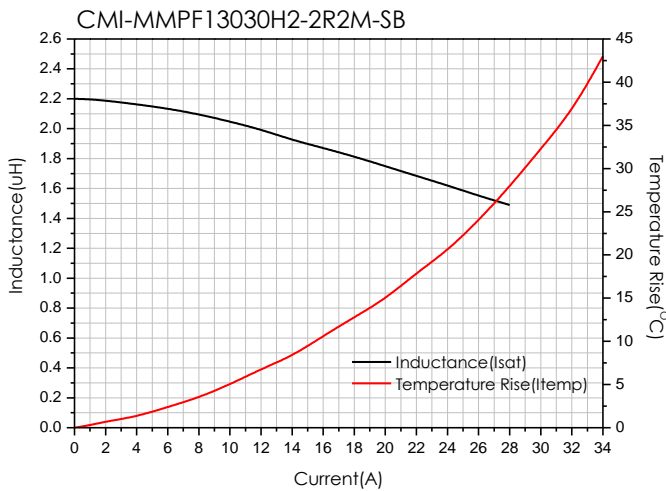
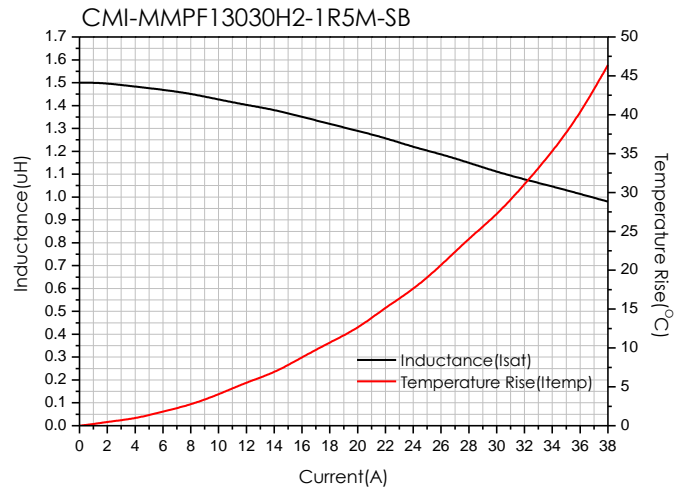
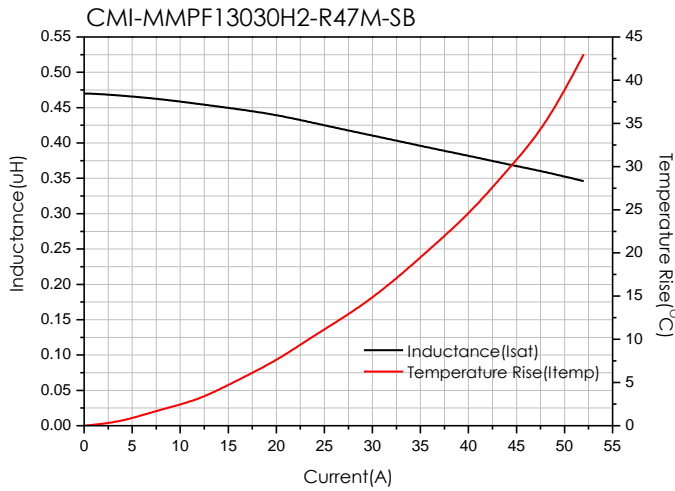
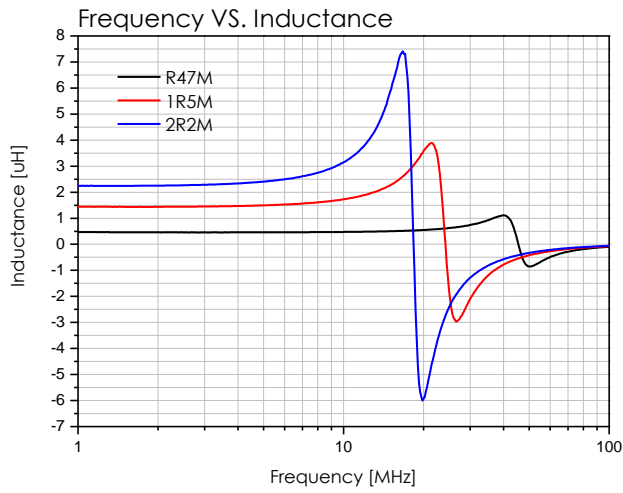

- You can also contact us by e-mail : [coilmaster@coilmaster.com](mailto:coilmaster@coilmaster.com)
- All specifications are subject to change without notice.
- Update date : 2023.07.11

## Packaging

(1) Package quantity : 800 (pcs/reel)

(2) Reel Dimensions (unit:mm)

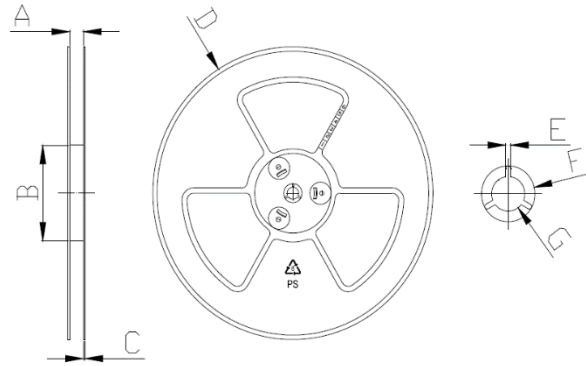

A	B	C	D	E	F	G
24.50	100.0	2.00	330.0	2.30	21.50	13.00
+1.00	+1.00	+0.10	+3.00	+0.30	+0.30	+0.50
-1.00	-1.00	-0.10	-3.00	-0.30	-0.30	-0.20

(3) Tape Dimensions

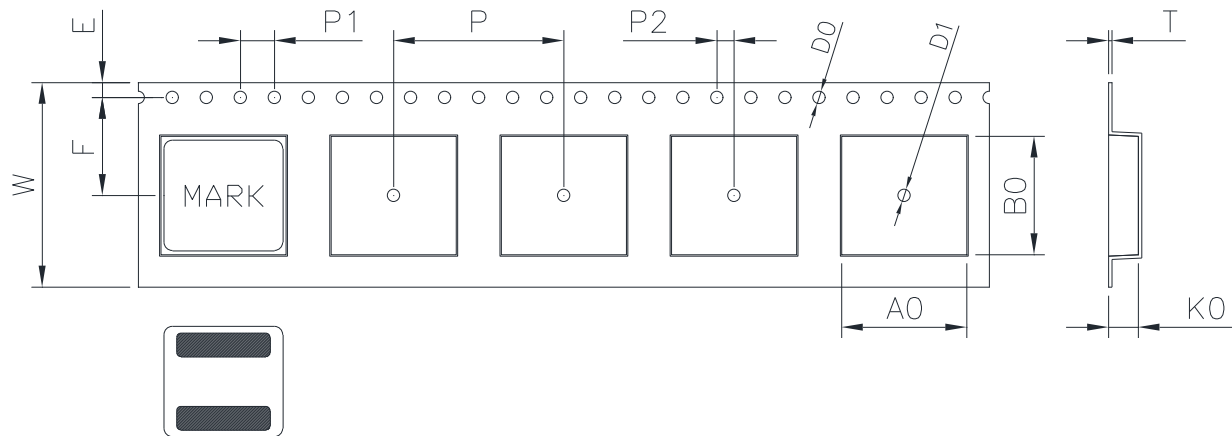

W	A0	B0	K0	E	F	P	P0	P2	D0/D1	T
24.00	14.70	13.90	3.50	1.75	11.50	20.00	4.00	2.00	1.50	0.40
+0.30	+0.10	+0.10	+0.10	+0.15	+0.10	+0.10	+0.10	+0.10	+0.10	+0.05
-0.30	-0.10	-0.10	-0.10	-0.10	-0.10	-0.10	-0.10	-0.10	-0.00	-0.05

Korea Sales Office (KOREA) +82)31-904-1444  
 China Sales Office (CHINA) +86)0758-683-1444  
 Hungary Sales office (EUROPE) +36)1-404-5832

H.K Sales Office (HONGKONG) +852)2711-5551  
 LA Sales Office (USA) +1)714-616-6989

• You can also contact us by e-mail : [coilmaster@coilmaster.com](mailto:coilmaster@coilmaster.com)

- All specifications are subject to change without notice.
- Update date : 2023.07.11

[www.coilmaster.com](http://www.coilmaster.com)