

CMI-MMPF4040QL-SB SERIES

Features

- ▶ Metal powder molding type for EMC protection.
- ▶ Lower DCR with applying flat wire.
- ▶ Available tape and reel for auto insertion.
- ▶ Halogen-Free.
- ▶ RoHS compliant.

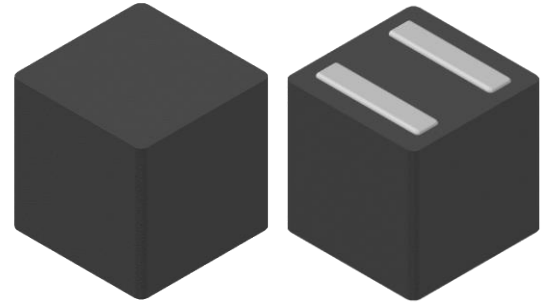

Applications

- ▶ For DC/DC Converter

Dimension (Unit:mm)

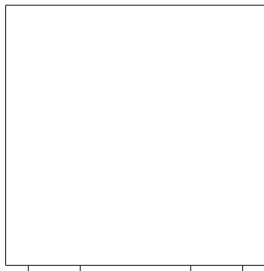
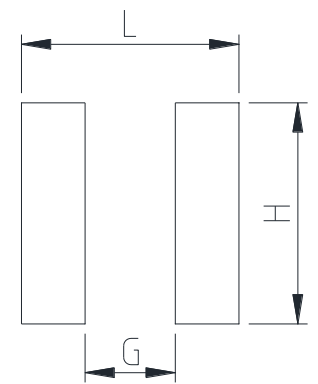
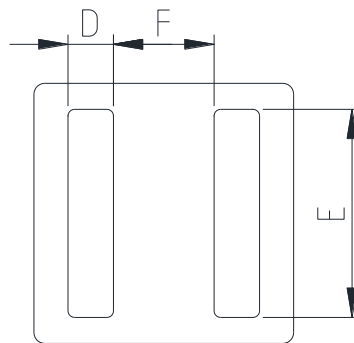
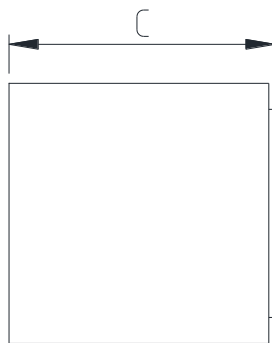
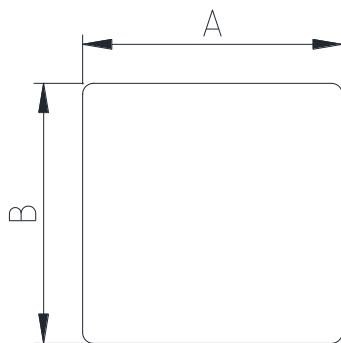

Land Pattern (Unit:mm)

A	B	C	D	E	F	G	H	L
4.0 ±0.3	4.0 ±0.3	4.1 Max.	0.7 ±0.2	3.2 Typ.	1.55 Typ.	1.39	3.40	3.35

Regulation of part number

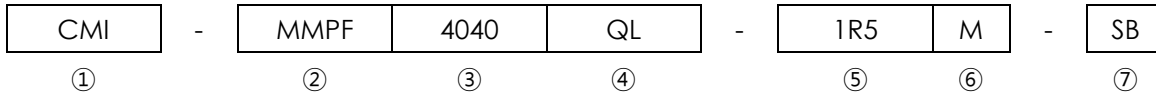

- ① CoilMaster's initial
- ② Series Name : Metal Molded Power inductor Flat wire type.
- ③ Core Size (unit:mm)
- ④ Material
- ⑤ Typical inductance value (1.5uH)
- ⑥ Inductance tolerance ($\pm 20\%$)
- ⑦ Type (SB)

Specifications

Part Number	Inductance (uH) $\pm 20\%$	DCR(mohm) Max.(Typ.)	Isat(A) Max.(Typ.)	Itemp(A) Max.(Typ.)	Test Frequency (Hz)
CMI-MMPF4040QL-1R5M-SB	1.5	13.2(11)	9.0(10.0)	11.0(12.0)	1M
CMI-MMPF4040QL-6R8M-SB	6.8	54(45)	4.3(4.8)	4.3(4.6)	1M

- Isat: When based on the inductance change rate (Approximately 30% below in the initial value)
- Itemp: When based on the temperature increase (Temperature increase of approximately 40°C by self heating)
- Operating Temperature Range (including self temperature) : -40°C ~ +125 °c

Note 1 : Circuit design, component placement, PCB trace size and thickness, airflow and other cooling. Provision all affect the part Temperature. Part temperature should be verified in the end application.

Electrical characteristics

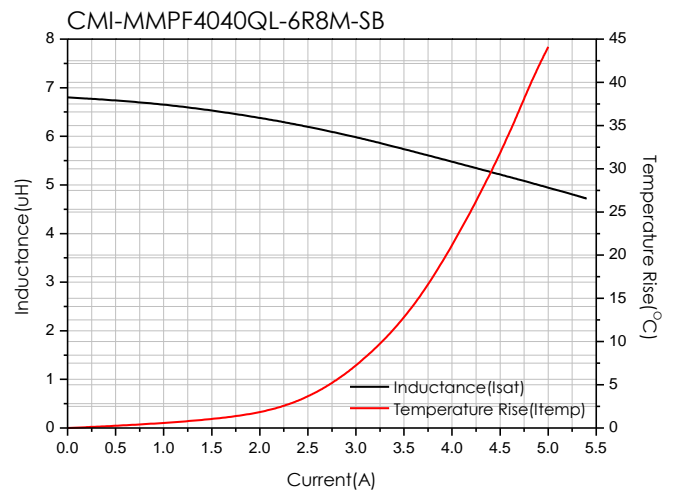
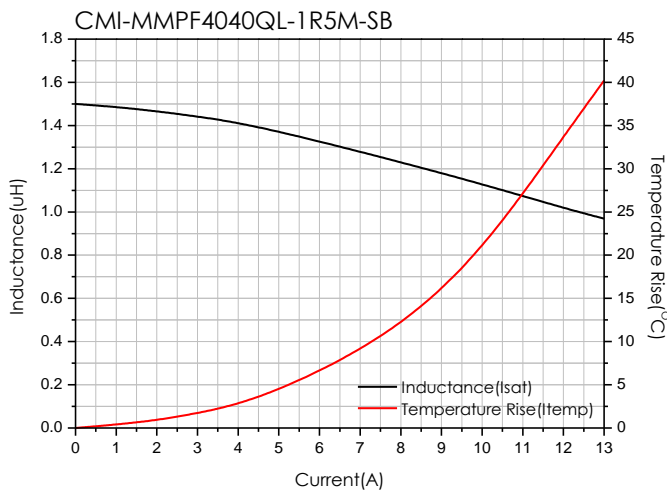

- You can also contact us by e-mail : coilmaster@coilmaster.com
- All specifications are subject to change without notice.
- Update date : 2021.12.28

Packaging

(1) Package quantity : 1,500 (pcs/reel)

(2) Reel Dimensions (unit:mm)



A	B	C	D	E	F	G
12.50	100.0	2.00	330.0	2.30	21.50	13.00
+0.50	+1.00	+0.20	+3.00	+0.30	+0.30	+0.50
-0.50	-1.00	-0.20	-3.00	-0.30	-0.30	-0.20

(3) Tape Dimensions

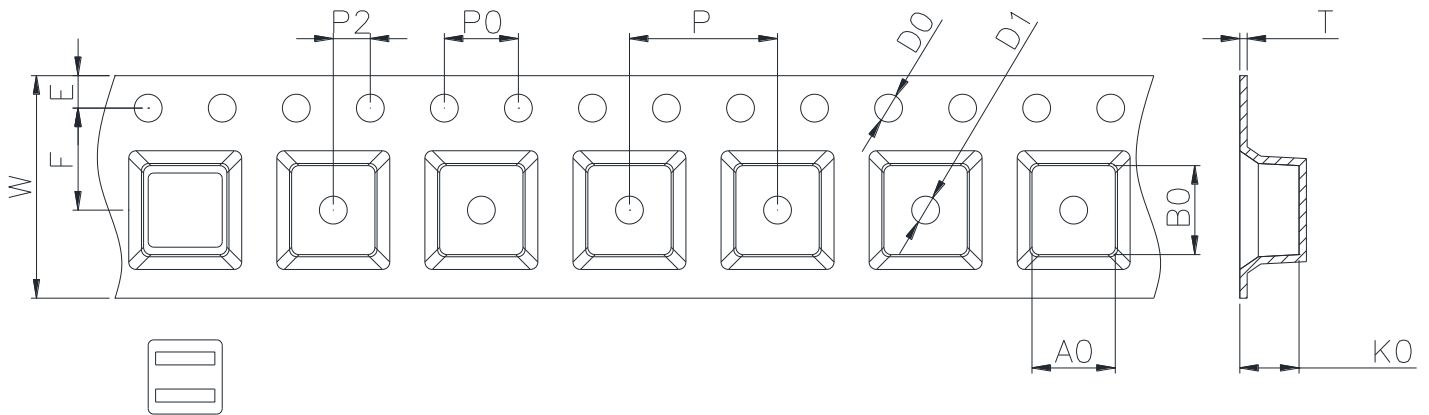

W	A0	B0	K0	E	F	P	P0	P2	D0/D1	T
12.00	4.40	4.40	4.30	1.75	5.50	8.00	4.00	2.00	1.50	0.40
+0.30	+0.10	+0.10	+0.10	+0.10	+0.10	+0.10	+0.10	+0.10	+0.10	+0.05
-0.10	-0.10	-0.10	-0.10	-0.10	-0.10	-0.10	-0.10	-0.10	-0.00	-0.05

Korea Sales Office (KOREA) +82)31-904-1444
 China Sales Office (CHINA) +86)0758-683-1444
 Hungary Sales office (EUROPE) +36)1-404-5832

H.K Sales Office (HONGKONG) +852)2711-5551
 LA Sales Office (USA) +1)714-616-6989

• You can also contact us by e-mail : coilmaster@coilmaster.com

- All specifications are subject to change without notice.
- Update date : 2021.12.28

www.coilmaster.com