

CMI-MMPP5030HL-SERIES

Features

- ▶ Metal powder molding type for EMC protection.
- ▶ Available tape and reel for auto insertion.
- ▶ Halogen-Free.
- ▶ RoHS compliant.

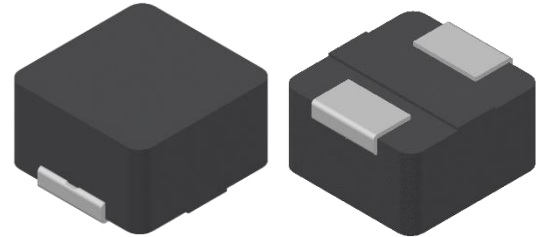

Applications

- ▶ For DC/DC converter, AV equipment digital consumer electronics

Dimension (Unit:mm)

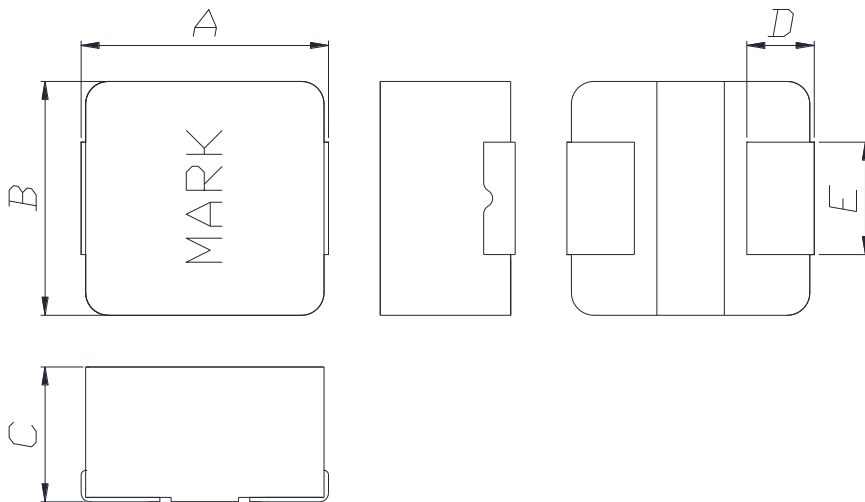

A	B	C	D	E
5.4 ±0.35	5.2 ±0.25	3.0 Max.	1.5 ±0.2	2.5 ±0.2

Land Pattern (Unit:mm)

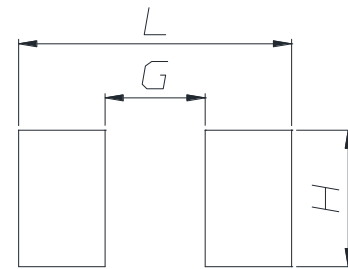

L	G	H
6.0	2.2	3.0

Regulation of part number

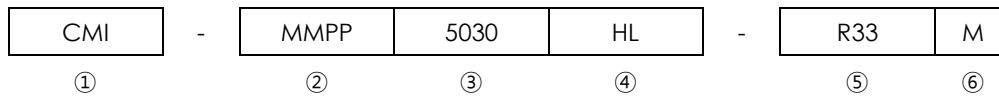

- ① CoilMaster's initial
- ② Series Name : Metal Molded Pin type Power inductor
- ③ Core Size (unit:mm)
- ④ Material
- ⑤ Typical inductance value (0.33uH)
- ⑥ Inductance tolerance ($\pm 20\%$)

Specifications

Part Number	Inductance (uH) $\pm 20\%$	DCR(mohm) Max.(Typ.)	Isat(A) Max.(Typ.)	Itemp(A) Max.(Typ.)	Test Frequency (Hz)
CMI-MMPP5030HL-R33M	0.33	4.8(4.0)	21.0(25.0)	14.5(15.0)	1M
CMI-MMPP5030HL-R47M	0.47	7.2(6.0)	14.0(16.0)	12.5(13.5)	1M
CMI-MMPP5030HL-R68M	0.68	7.8(6.5)	13.0(15.0)	12.0(13.0)	1M
CMI-MMPP5030HL-1R0M	1.0	12(10)	11.0(13.0)	8.5(9.5)	1M
CMI-MMPP5030HL-1R5M	1.5	21(17.5)	10.0(11.0)	7.0(7.5)	1M
CMI-MMPP5030HL-2R2M	2.2	24(20)	9.0(9.5)	6.0(6.5)	1M
CMI-MMPP5030HL-3R3M	3.3	36(30)	7.5(8.0)	5.7(6.0)	1M
CMI-MMPP5030HL-4R7M	4.7	44.4(37)	6.2(6.7)	5.1(5.5)	1M
CMI-MMPP5030HL-5R6M	5.6	60(50)	5.5(6.0)	4.3(4.8)	1M
CMI-MMPP5030HL-6R8M	6.8	66(55)	4.8(5.3)	3.8(4.2)	1M
CMI-MMPP5030HL-100M	10	100(85)	3.6(4.0)	3.2(3.6)	1M
CMI-MMPP5030HL-150M	15	190(160)	3.1(3.5)	2.3(2.5)	1M
CMI-MMPP5030HL-220M	22	220(185)	2.5(2.8)	2.0(2.2)	1M

- Isat: When based on the inductance change rate (Approximately 30% below in the initial value)
- Itemp: When based on the temperature increase (Temperature increase of approximately 40°C by self heating)
- Operating Temperature Range (including self temperature) : -40°C ~ +125 °c

Note 1 : Circuit design, component placement, PCB trace size and thickness, airflow and other cooling. Provision all affect the part Temperature. Part temperature should be verified in the end application.

▪ **You can also contact us by e-mail : coilmaster@coilmaster.com**

- All specifications are subject to change without notice.
- Update date : 2023.06.22

www.coilmaster.com

Electrical characteristics

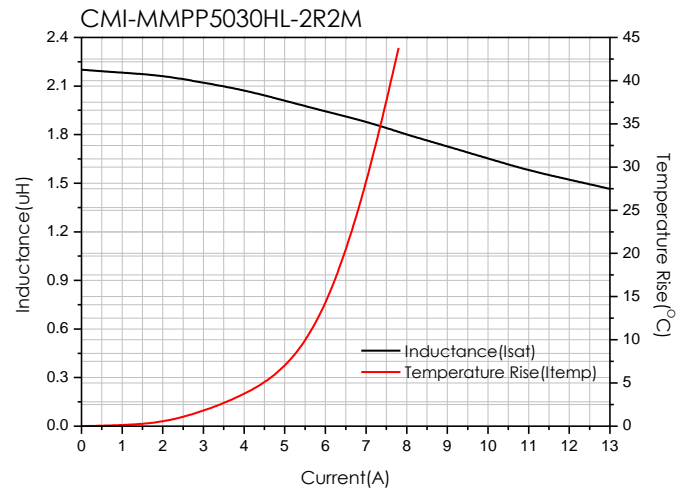
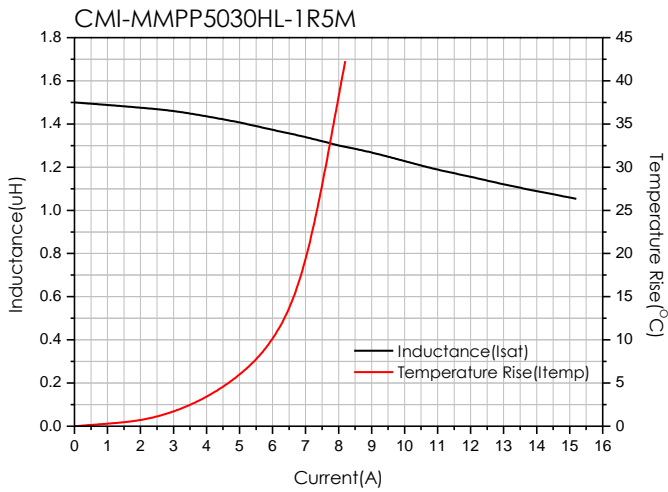
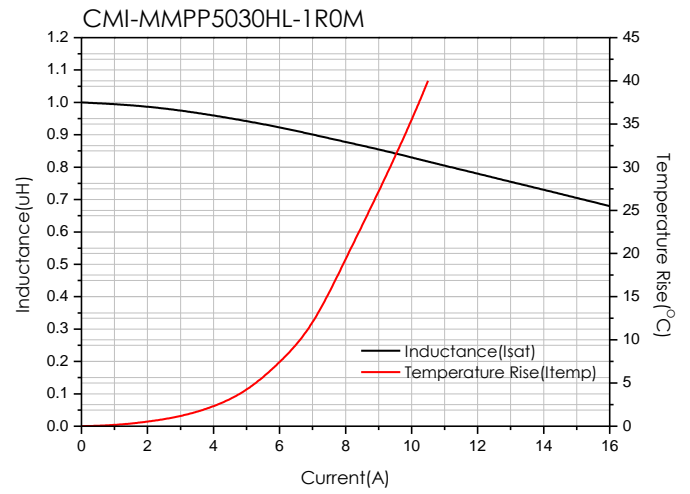
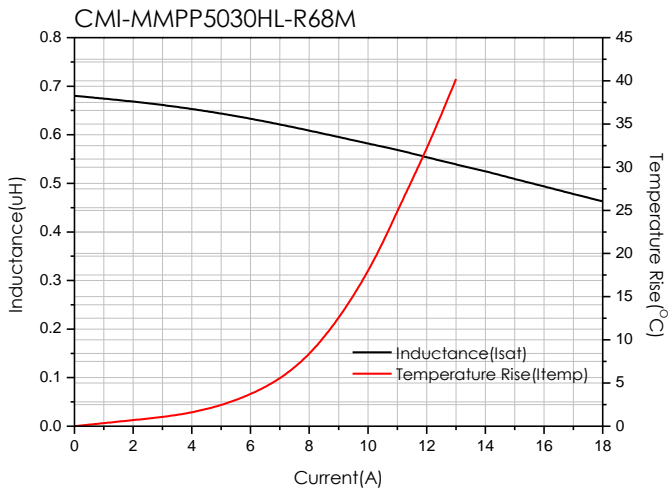
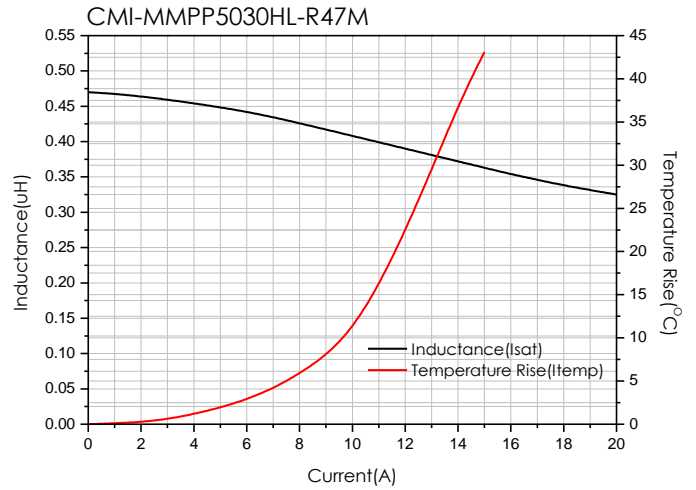
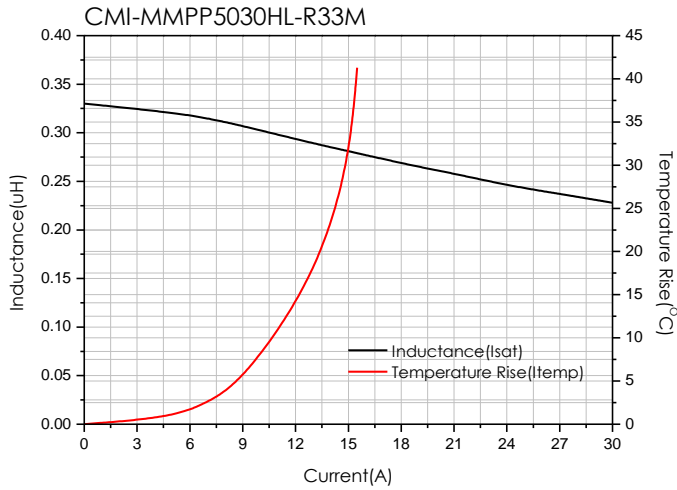

- You can also contact us by e-mail : coilmaster@coilmaster.com
- All specifications are subject to change without notice.
- Update date : 2023.06.22

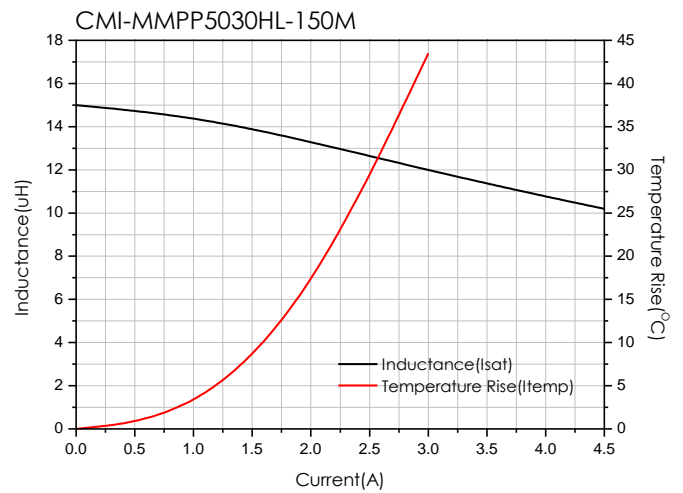
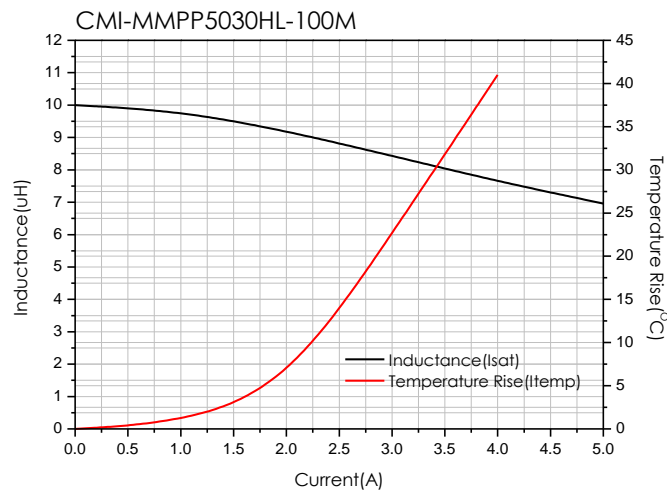
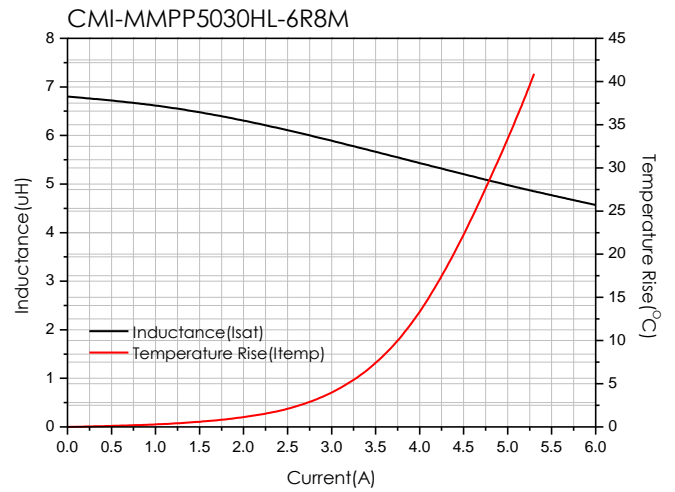
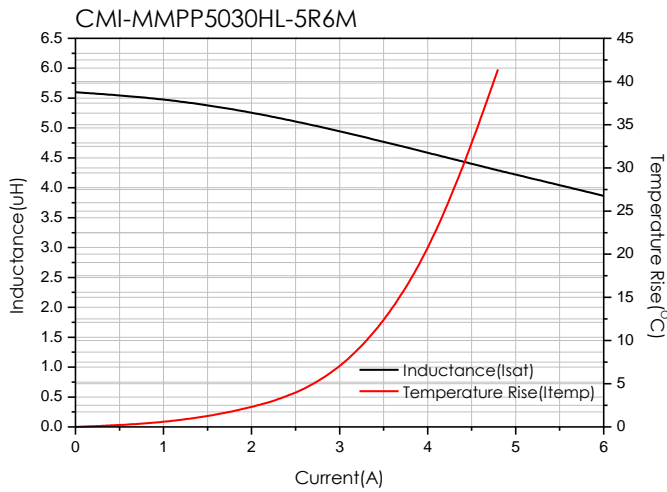
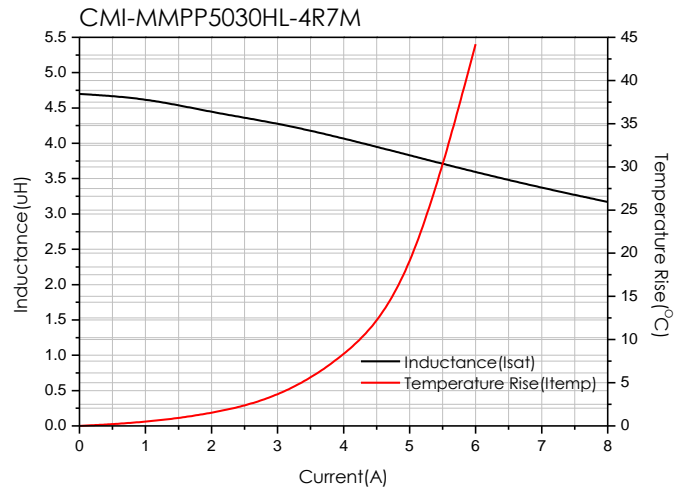
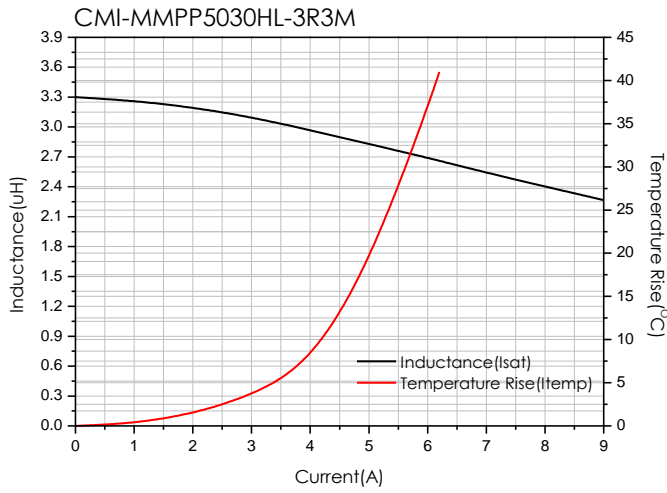

- You can also contact us by e-mail : coilmaster@coilmaster.com
- All specifications are subject to change without notice.
- Update date : 2023.06.22

CMI-MMPP5030HL-220M

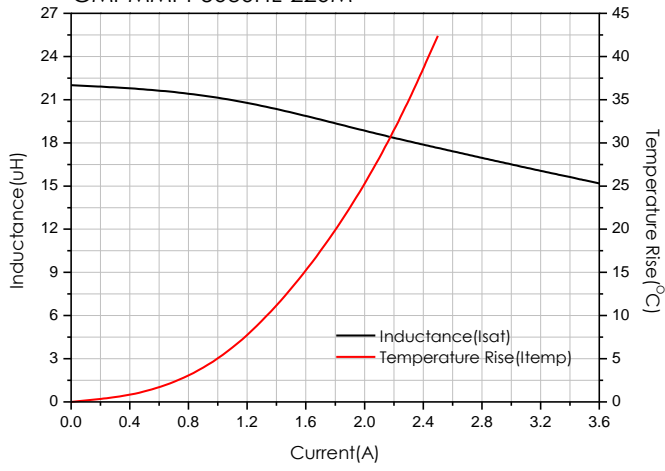

- You can also contact us by e-mail : coilmaster@coilmaster.com
- All specifications are subject to change without notice.
- Update date : 2023.06.22

Packaging

(1) Package quantity : 1,500 (pcs/reel)

(2) Reel Dimensions (unit:mm)

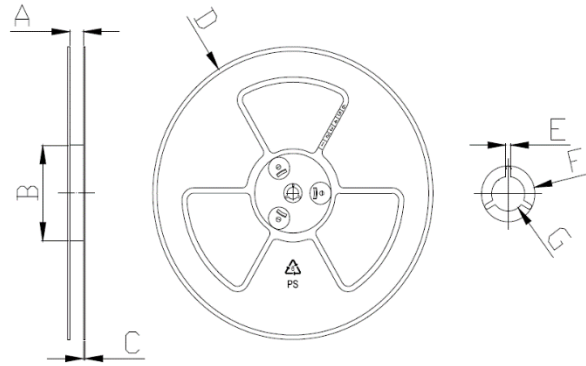

A	B	C	D	E	F	G
12.50	100.0	2.00	330.0	1.90	21.00	13.00
+1.00	+1.50	+0.10	+1.00	+0.40	+0.40	+0.40
-1.00	-1.50	-0.10	-1.00	-0.40	-0.40	-0.40

(3) Tape Dimensions

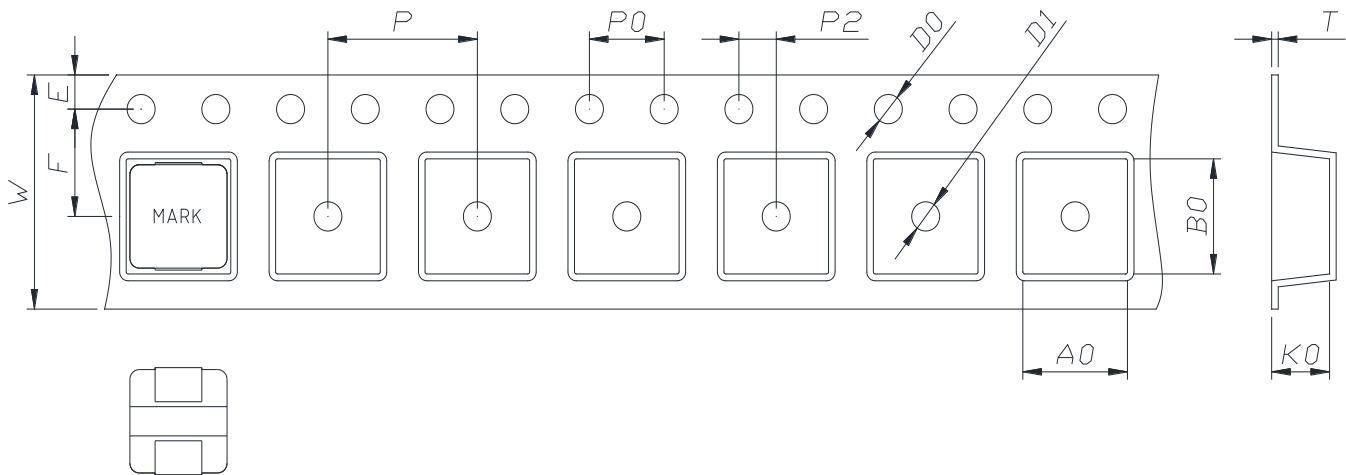

W	A0	B0	K0	E	F	P	P0	P2	D0/D1	T
12.00	5.60	5.90	3.10	1.75	5.50	8.00	4.00	2.00	1.50	0.30
+0.30	+0.10	+0.10	+0.10	+0.10	+0.10	+0.10	+0.10	+0.10	+0.10	+0.05
-0.10	-0.00	-0.00	-0.10	-0.10	-0.10	-0.10	-0.10	-0.10	-0.00	-0.05

Korea Sales Office (KOREA) +82)31-904-1444
 China Sales Office (CHINA) +86)0758-683-1444
 Hungary Sales office (EUROPE) +36)1-404-5832

H.K Sales Office (HONGKONG) +852)2711-5551
 LA Sales Office (USA) +1)714-616-6989

• You can also contact us by e-mail : coilmaster@coilmaster.com

- All specifications are subject to change without notice.
- Update date : 2023.06.22

www.coilmaster.com