

CMI-MMPP5040HL-SERIES

Features

- ▶ Metal powder molding type for EMC protection.
- ▶ Available tape and reel for auto insertion.
- ▶ Halogen-Free.
- ▶ RoHS compliant.

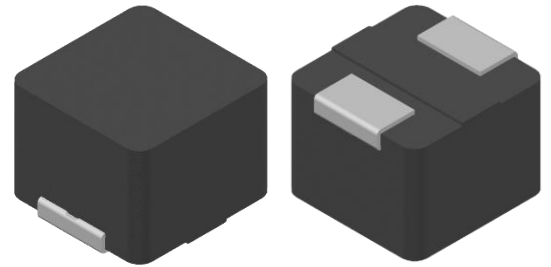

Applications

- ▶ For DC/DC converter, AV equipment digital consumer electronics

Dimension (Unit:mm)

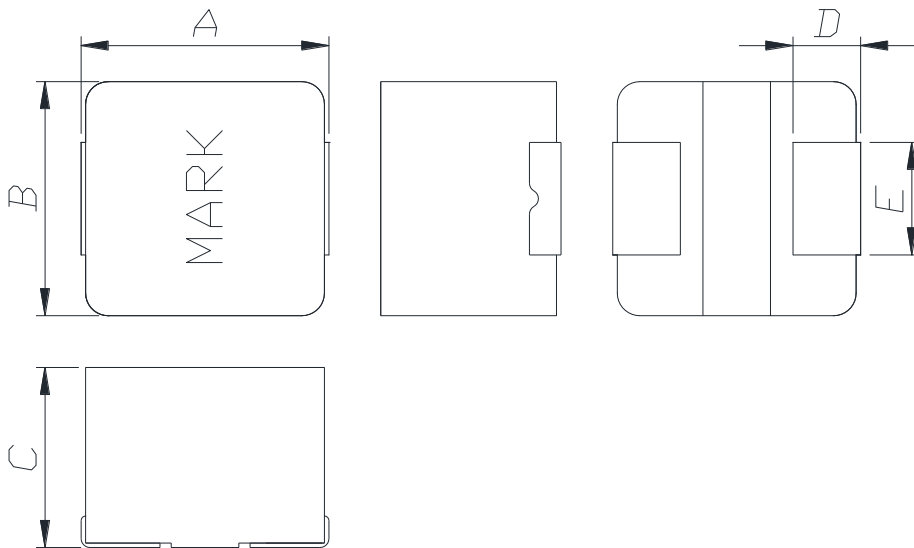

Land Pattern (Unit:mm)

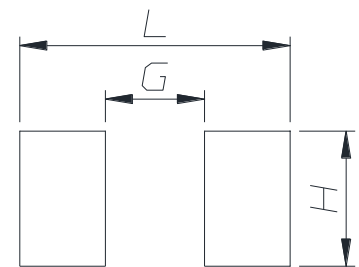

A	B	C	D	E
5.4 ±0.35	5.2 ±0.25	4.0 Max.	1.5 ±0.2	2.5 ±0.2

L	G	H
6.0	2.2	3.0

Electrical characteristics

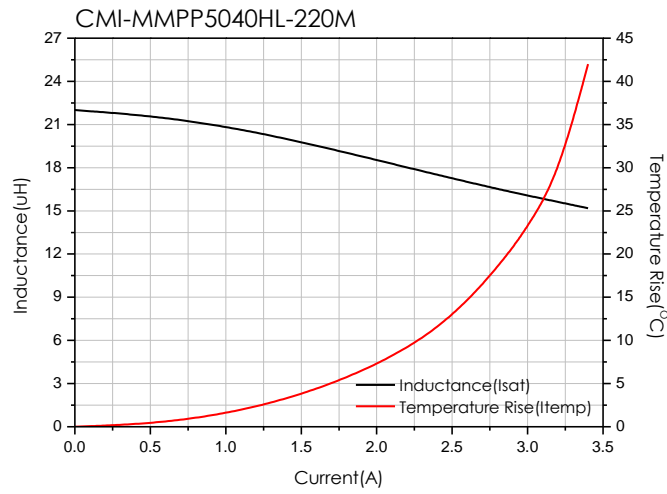
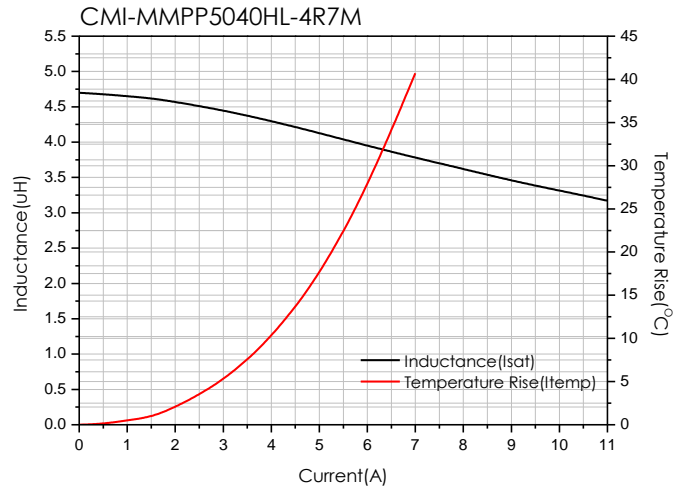
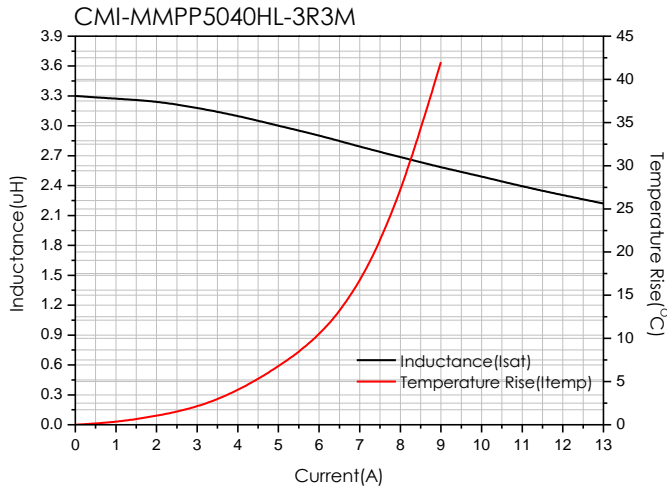

- You can also contact us by e-mail : coilmaster@coilmaster.com
- All specifications are subject to change without notice.
- Update date : 2023.12.07

Packaging

(1) Package quantity : 1,000 (pcs/reel)

(2) Reel Dimensions (unit:mm)

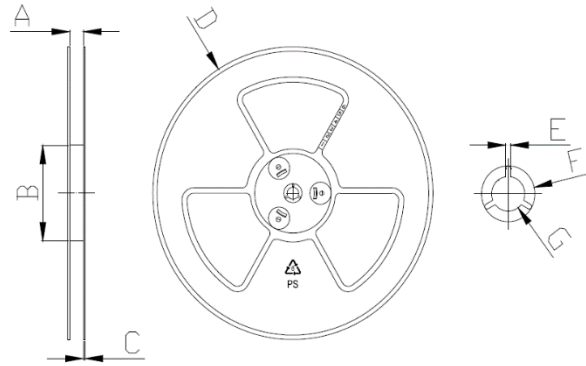

A	B	C	D	E	F	G
12.50	100.0	2.00	330.0	1.90	21.00	13.00
+1.00	+1.50	+0.10	+1.00	+0.40	+0.40	+0.40
-1.00	-1.50	-0.10	-1.00	-0.40	-0.40	-0.40

(3) Tape Dimensions

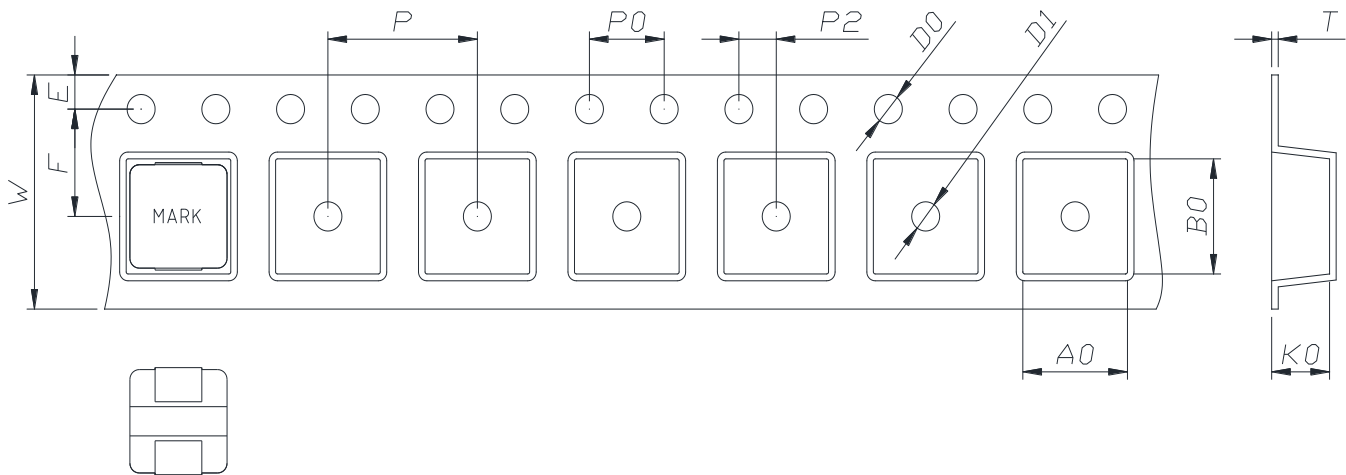

W	A0	B0	K0	E	F	P	P0	P2	D0/D1	T
12.00	5.60	6.10	4.30	1.75	5.50	8.00	4.00	2.00	1.50	0.35
+0.30	+0.10	+0.10	+0.10	+0.10	+0.10	+0.10	+0.10	+0.10	+0.10	+0.05
-0.10	-0.00	-0.00	-0.10	-0.10	-0.10	-0.10	-0.10	-0.10	-0.00	-0.05

Korea Sales Office (KOREA) +82)31-904-1444
 China Sales Office (CHINA) +86)0758-683-1444
 Hungary Sales office (EUROPE) +36)1-404-5832

H.K Sales Office (HONGKONG) +852)2711-5551
 LA Sales Office (USA) +1)714-616-6989

• You can also contact us by e-mail : coilmaster@coilmaster.com

- All specifications are subject to change without notice.
- Update date : 2023.12.07

www.coilmaster.com