

CME-NMCB1 60808H-SERIES

Features

- ▶ Halogen-Free / RoHS compliant.
- ▶ Small size chips generate high impedance
- ▶ Monolithic structure for high reliability
- ▶ Excellent solderability and high heat resistance for either flow or reflow soldering
- ▶ Low DC resistance structure of electrode prevents wasteful electric power consumption



Applications

- ▶ Mother board, Tablet PC, Notebook, Desktop computers and peripheral equipment / DSC, DVC, LCD TV, Set top box / Mobile phone, Smart phone, PND / Digital communication equipment / Various automotive electronics / Circuit where a stable ground is unavailable

Dimension (Unit:mm)

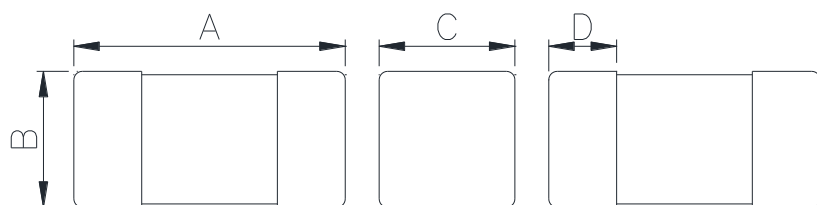

A	B	C	D
1.6±0.15	0.8±0.15	0.8±0.15	0.2~0.6

Land Pattern (Unit:mm)

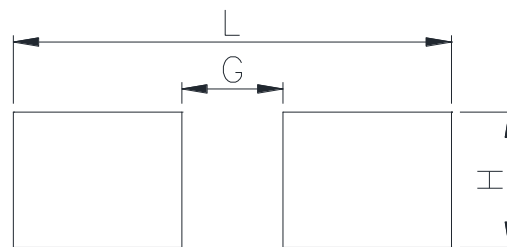

L	G	H
2.6	0.6	0.8

Regulation of part number

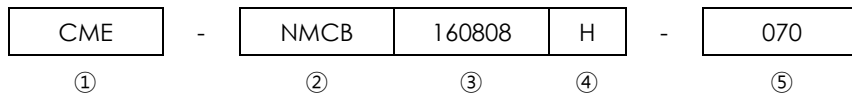

- ① CoilMaster's initial
- ② Product Series Name
- ③ Core Size (unit:mm)
- ④ Material Code
- ⑤ Normal Impedance (070 : 7 ohm)

Specifications

Part Number	Impedance (ohm) $\pm 25\%$	DCR(ohm) Max.	Rated Current (mA)Max.
CME-NMCB160808H-070	7	0.10	900
CME-NMCB160808H-100	10	0.10	900
CME-NMCB160808H-680	68	0.10	700
CME-NMCB160808H-121	120	0.30	300
CME-NMCB160808H-301	300	0.35	300
CME-NMCB160808H-601	600	0.65	300
CME-NMCB160808H-102	1000	1.10	50

- Test Condition : 100 MHz, 500 mV
- Rated Current : the DC current value having temperature increased 40 °c after thru DC current 2 hours at ambient temperature.
- Storage Temperature Range : -40 °c ~ +85 °c
- Operating Temperature Range : -55 °c ~ +125 °c

Note 1 : Circuit design, component placement, PCB trace size and thickness, airflow and other cooling. Provision all affect the part Temperature. Part temperature should be verified in the end application.

▪ **You can also contact us by e-mail : coilmaster@coilmaster.com**

- All specifications are subject to change without notice.
- Update date : 2023.03.29

www.coilmaster.com

Electrical characteristics

CME-NMCB160808H-070

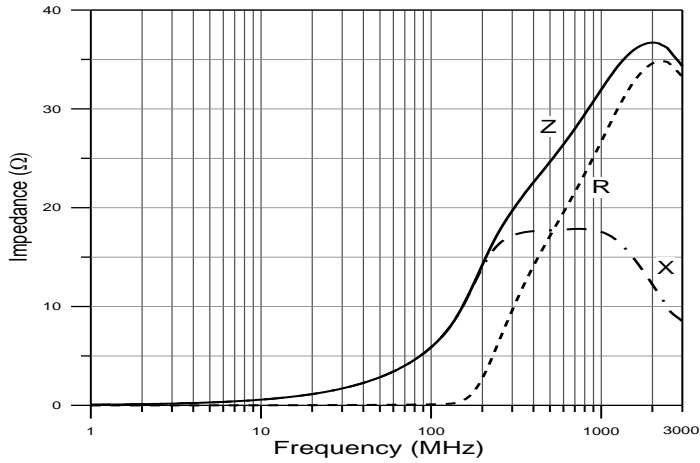

CME- NMCB160808H-100

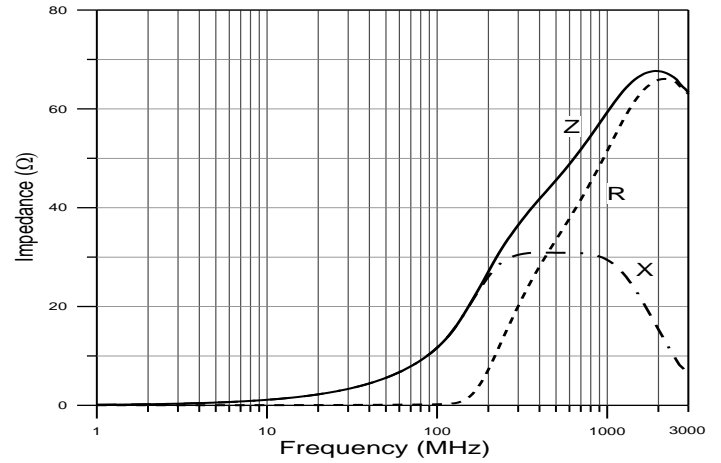

CME- NMCB160808H-121

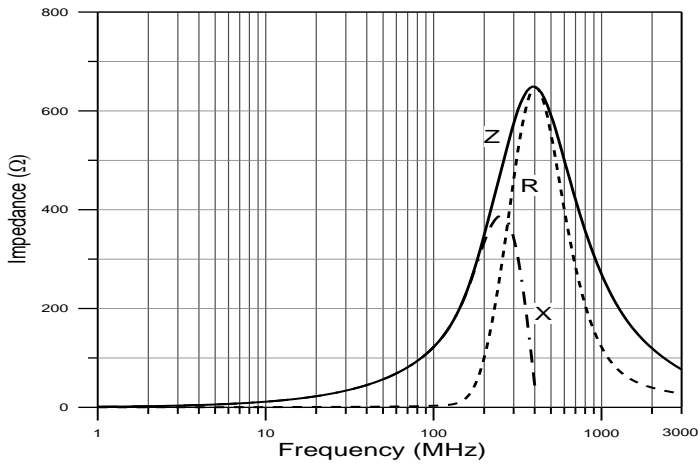

CME- NMCB160808H-301

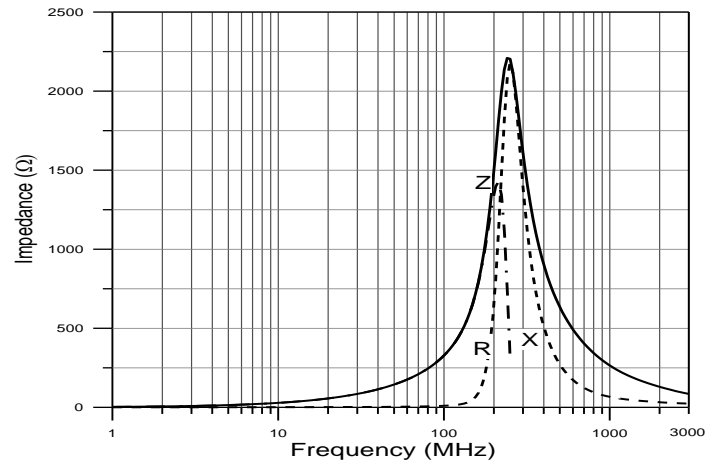

CME- NMCB160808H-601

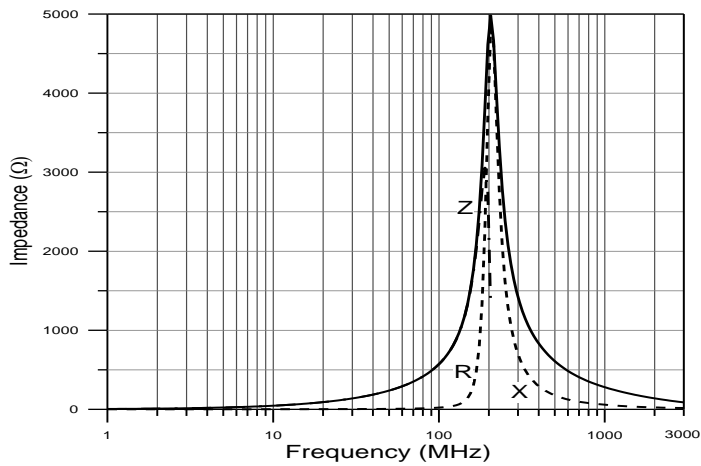

- You can also contact us by e-mail : coilmaster@coilmaster.com
- All specifications are subject to change without notice.
- Update date : 2023.03.29

Packaging

(1) Package quantity : 4,000 (pcs/reel)

(2) Reel Dimensions (unit:mm)

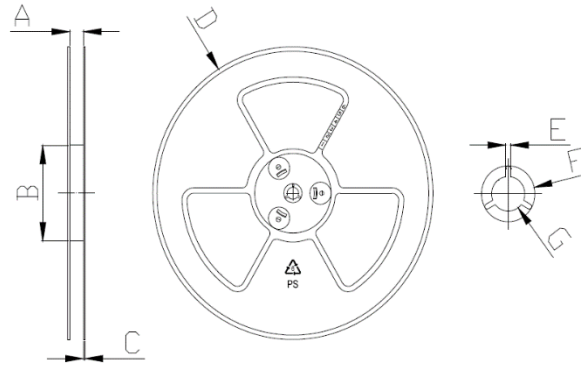

A	B	C	D	E	F	G
10.00	60.00	2.00	178.0	2.00	21.00	13.00
+1.50	+2.00	+0.50	+2.00	+0.50	+0.80	+0.80
-1.50	-2.00	-0.50	-2.00	-0.50	-0.80	-0.80

(3) Tape Dimensions

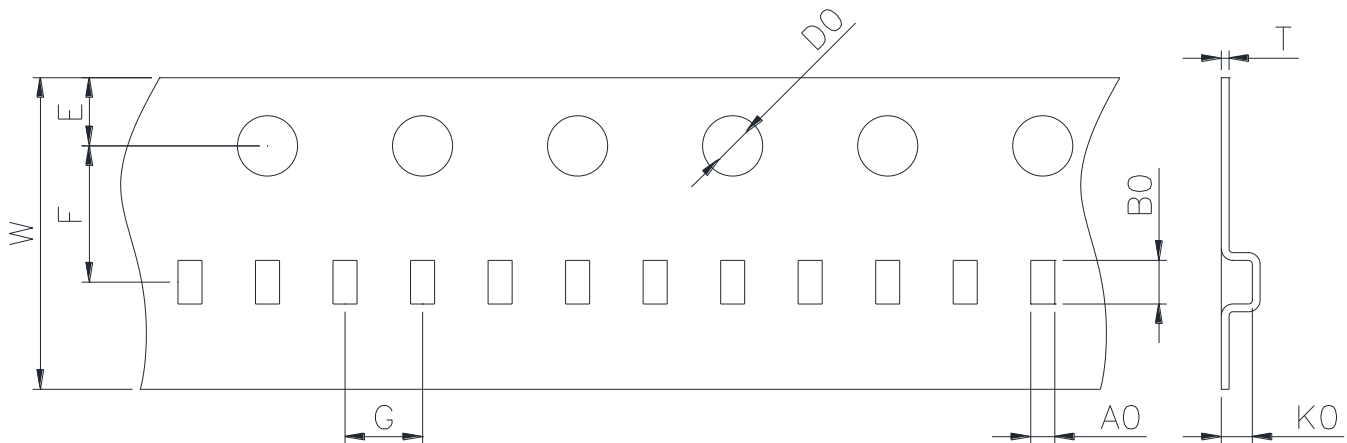

W	A0	B0	T	E	F	G	D0	K0
8.00	1.10	1.90	0.20	1.75	3.50	4.00	1.50	1.10
+0.20	+0.10	+0.10	+0.05	+0.10	+0.05	+0.10	+0.10	+0.05
-0.20	-0.10	-0.10	-0.05	-0.10	-0.05	-0.10	-0.00	-0.05

Korea Sales Office (KOREA) +82)31-904-1444

China Sales Office (CHINA) +86)0758-683-1444

Hungary Sales office (EUROPE) +36)1-404-5832

H.K Sales Office (HONGKONG) +852)2711-5551

LA Sales Office (USA) +1)714-616-6989

• You can also contact us by e-mail : coilmaster@coilmaster.com

• All specifications are subject to change without notice.

• Update date : 2023.03.29

www.coilmaster.com