

# CME-NMCB201209B-SERIES

## Features

- ▶ Halogen-Free / RoHS compliant.
- ▶ Small size chips generate high impedance
- ▶ Monolithic structure for high reliability
- ▶ Excellent solderability and high heat resistance for either flow or reflow soldering
- ▶ Low DC resistance structure of electrode prevents wasteful electric power consumption



## Applications

- ▶ Mother board, Tablet PC, Notebook, Desktop computers and peripheral equipment / DSC, DVC, LCD TV, Set top box / Mobile phone, Smart phone, PND / Digital communication equipment / Various automotive electronics / Circuit where a stable ground is unavailable

Dimension (Unit:mm)

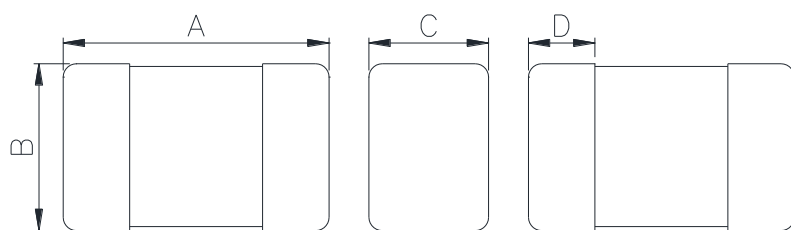

A	B	C	D
2.0±0.2	1.25±0.2	0.9 <sup>+0.15</sup> <sub>-0.2</sub>	0.2~0.8

Land Pattern (Unit:mm)

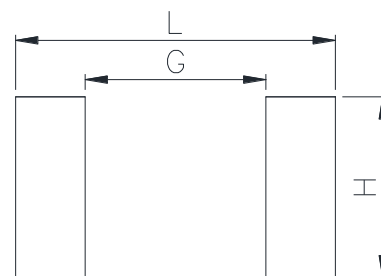

L	G	H
2.3	1.3	1.3

## Regulation of part number

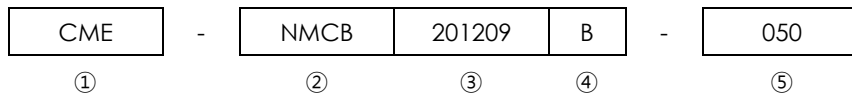

- ① CoilMaster's initial
- ② Product Series Name
- ③ Core Size (unit:mm)
- ④ Material Code
- ⑤ Normal Impedance (050 : 5 ohm)

## Specifications

Part Number	Impedance (ohm) $\pm 25\%$	DCR(ohm) Max.	Rated Current (mA)Max.
CME-NMCB201209B-050	5	0.07	500
CME-NMCB201209B-300	30	0.15	300
CME-NMCB201209B-600	60	0.15	300
CME-NMCB201209B-750	75	0.20	300
CME-NMCB201209B-101	100	0.20	300
CME-NMCB201209B-121	120	0.20	300
CME-NMCB201209B-221	220	0.25	200
CME-NMCB201209B-301	300	0.25	200
CME-NMCB201209B-601	600	0.25	200
CME-NMCB201209B-751	750	0.30	200
CME-NMCB201209B-102	1000	0.30	200
CME-NMCB201209B-152	1500	0.35	200
CME-NMCB201209B-182	1800	0.40	200
CME-NMCB201209B-202	2000	0.40	200
CME-NMCB201209B-222	2200	0.50	200
CME-NMCB201209B-252	2500	0.60	200
CME-NMCB201209B-272	2700	0.60	200

- Test Condition : 100 MHz, 500 mV
- Rated Current : the DC current value having temperature increased 40 °c after thru DC current 2 hours at ambient temperature.
- Storage Temperature Range : -40°c ~ +85 °c
- Operating Temperature Range : -55°c ~ +125 °c

Note 1 : Circuit design, component placement, PCB trace size and thickness, airflow and other cooling. Provision all affect the part Temperature. Part temperature should be verified in the end application.

▪ **You can also contact us by e-mail : [coilmaster@coilmaster.com](mailto:coilmaster@coilmaster.com)**

- All specifications are subject to change without notice.
- Update date : 2023.03.29

[www.coilmaster.com](http://www.coilmaster.com)

# Electrical characteristics

CME-NMCB201209B-050

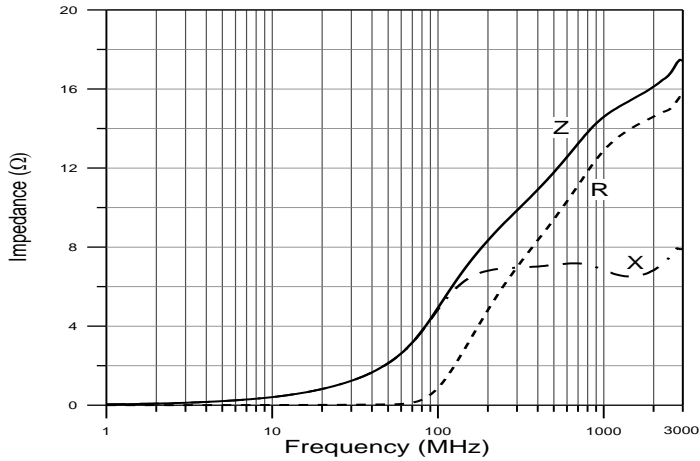

CME- NMCB201209B-300

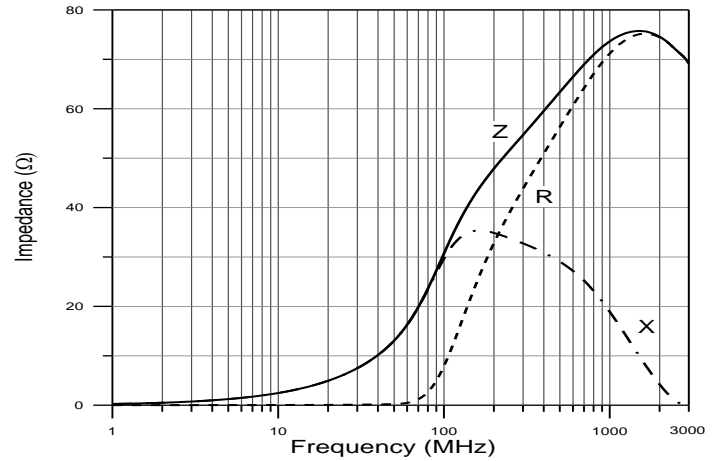

CME- NMCB201209B-600

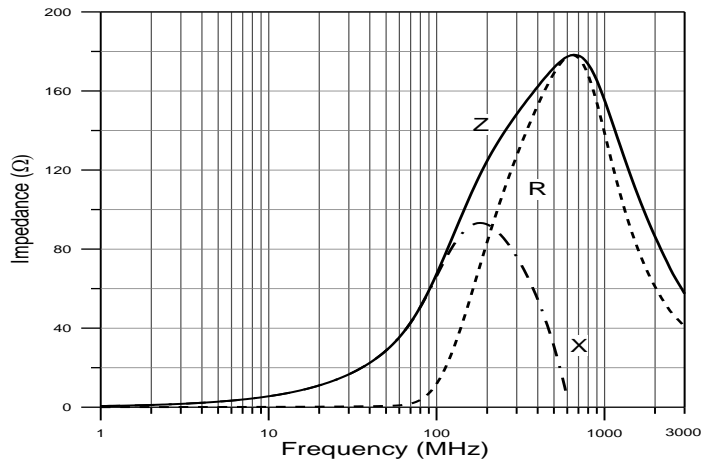

CME- NMCB201209B-101

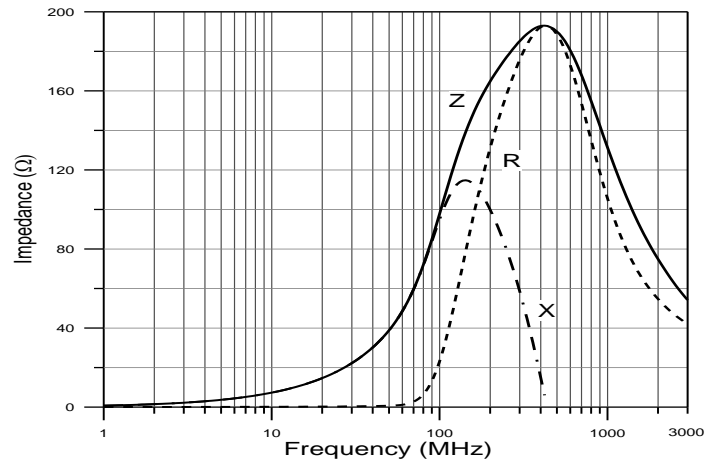

CME- NMCB201209B-121

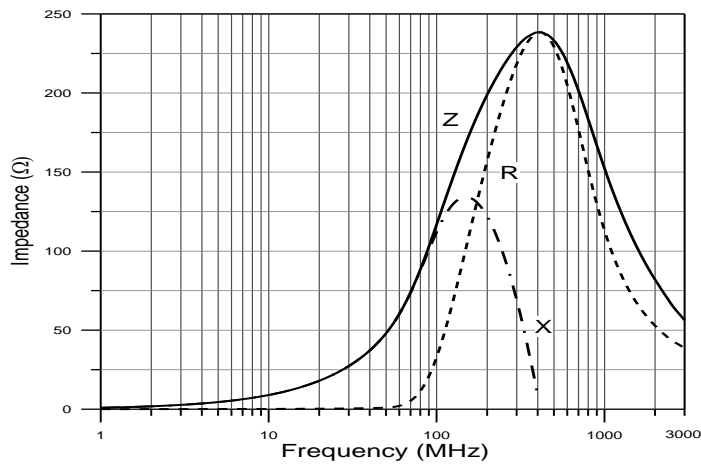

CME- NMCB201209B-221

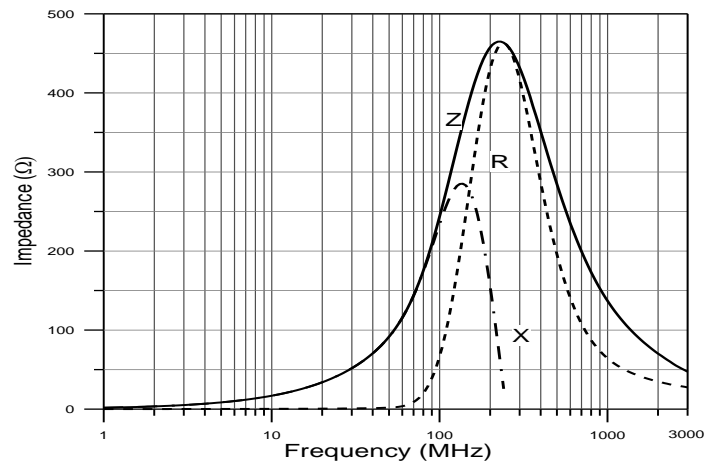

- You can also contact us by e-mail : [coilmaster@coilmaster.com](mailto:coilmaster@coilmaster.com)
- All specifications are subject to change without notice.
- Update date : 2023.03.29

CME- NMCB201209B-301

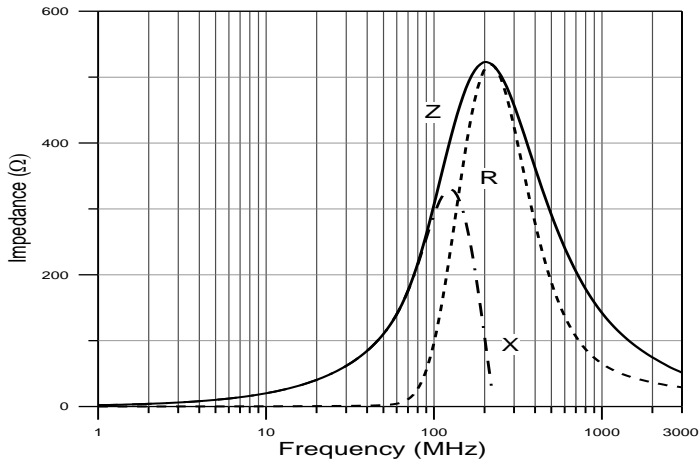

CME- NMCB201209B-601

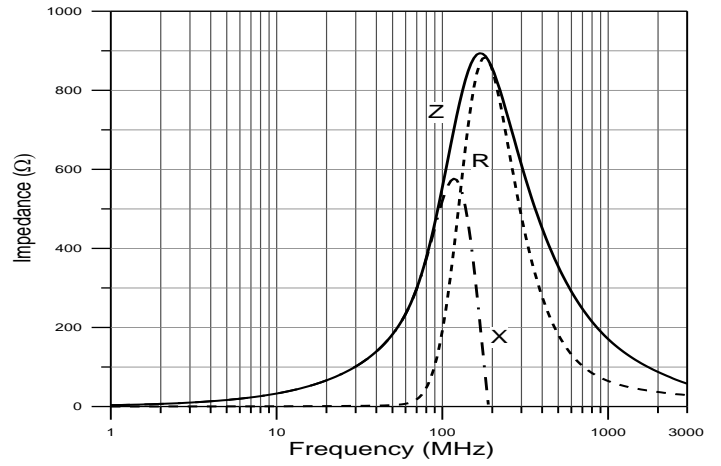

CME- NMCB201209B-751

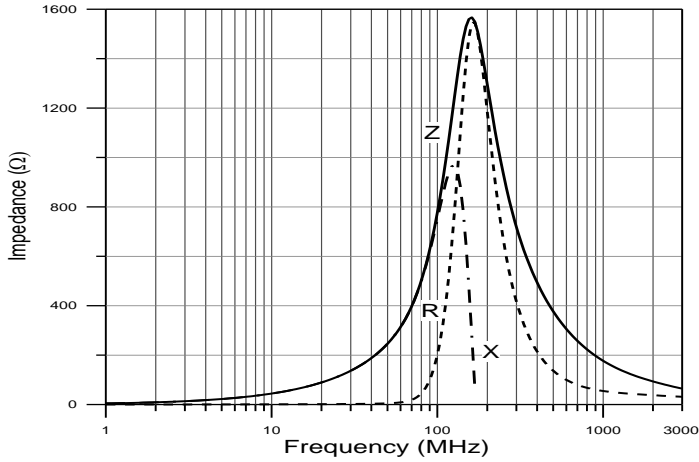

CME- NMCB201209B-102

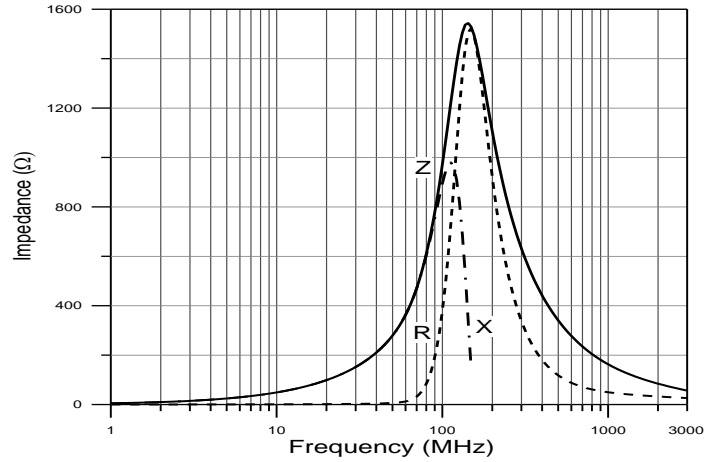

CME- NMCB201209B-122

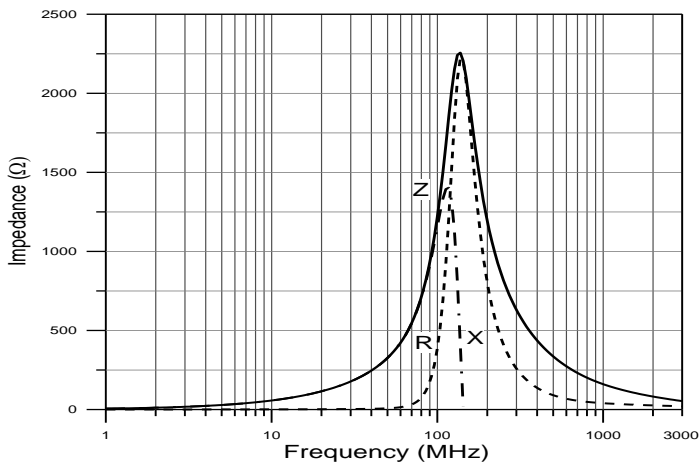

CME- NMCB201209B-152

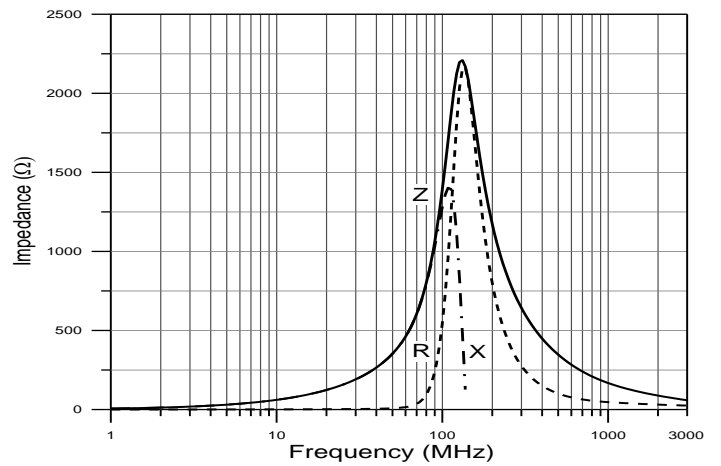

- You can also contact us by e-mail : [coilmaster@coilmaster.com](mailto:coilmaster@coilmaster.com)
- All specifications are subject to change without notice.
- Update date : 2023.03.29

CME- NMCB201209B-182

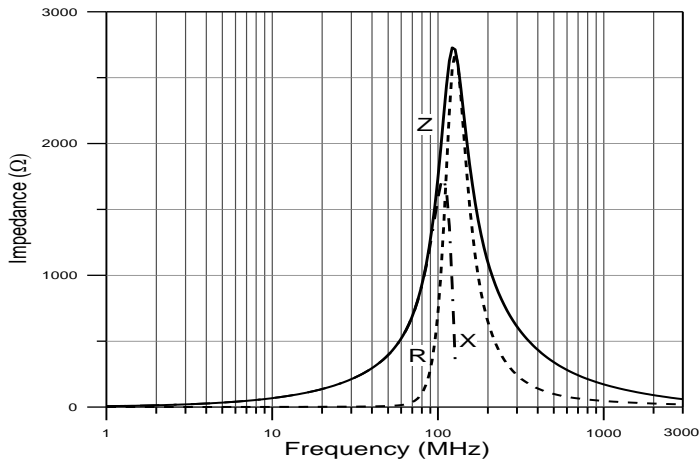

CME- NMCB201209B-222

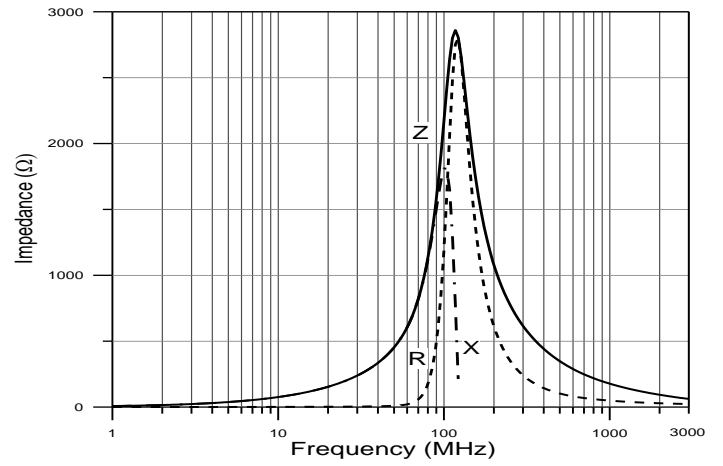

CME- NMCB201209B-252

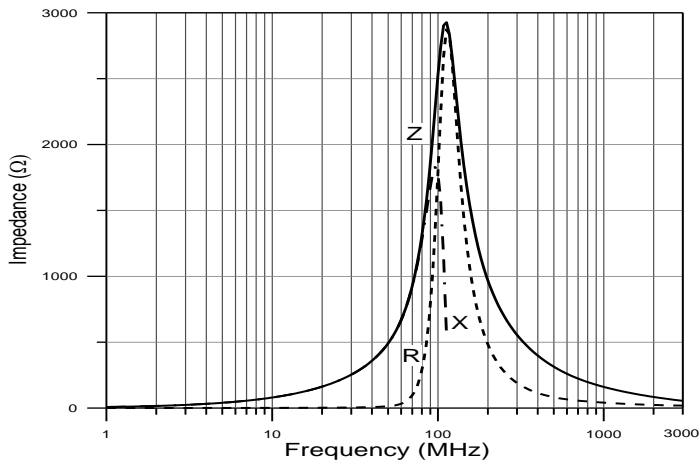

CME- NMCB201209B-272

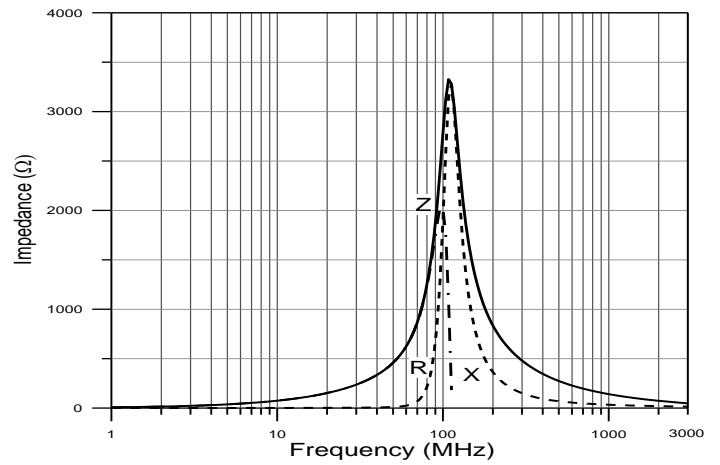

- You can also contact us by e-mail : [coilmaster@coilmaster.com](mailto:coilmaster@coilmaster.com)
- All specifications are subject to change without notice.
- Update date : 2023.03.29

## Packaging

(1) Package quantity : 4,000 (pcs/reel)

(2) Reel Dimensions (unit:mm)

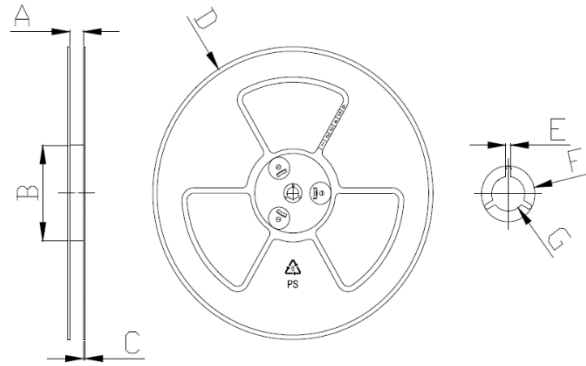

A	B	C	D	E	F	G
10.00	60.00	2.00	178.0	2.00	21.00	13.00
+1.50	+2.00	+0.50	+2.00	+0.50	+0.80	+0.80
-1.50	-2.00	-0.50	-2.00	-0.50	-0.80	-0.80

(3) Tape Dimensions

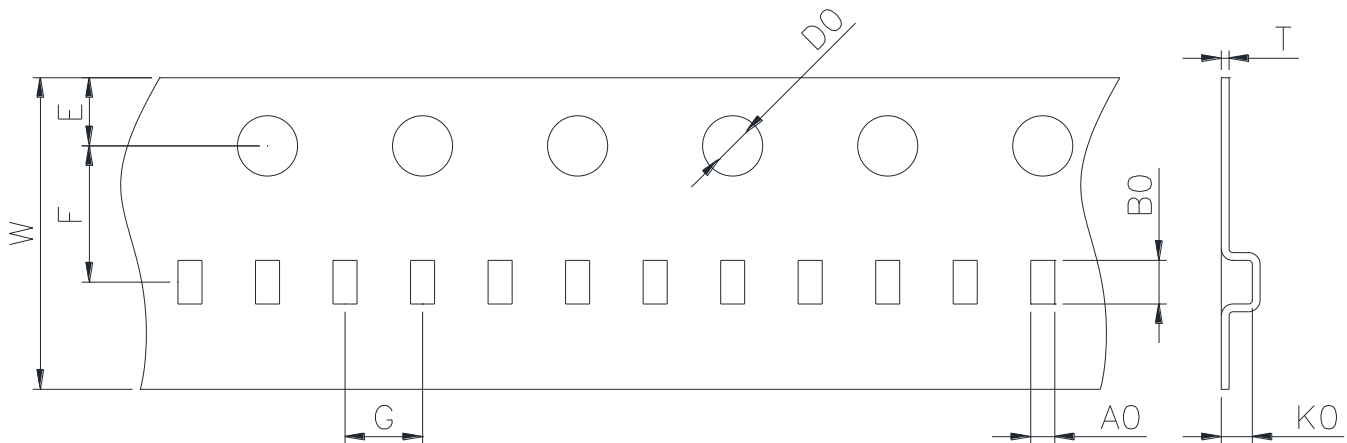

W	A0	B0	T	E	F	G	D0	K0
8.00	1.55	2.30	0.20	1.75	3.50	4.00	1.50	1.20
+0.20	+0.10	+0.10	+0.05	+0.10	+0.05	+0.10	+0.10	+0.05
-0.20	-0.10	-0.10	-0.05	-0.10	-0.05	-0.10	-0.00	-0.05

Korea Sales Office (KOREA) +82)31-904-1444  
 China Sales Office (CHINA) +86)0758-683-1444  
 Hungary Sales office (EUROPE) +36)1-404-5832

H.K Sales Office (HONGKONG) +852)2711-5551  
 LA Sales Office (USA) +1)714-616-6989

• You can also contact us by e-mail : [coilmaster@coilmaster.com](mailto:coilmaster@coilmaster.com)

- All specifications are subject to change without notice.
- Update date : 2023.03.29

[www.coilmaster.com](http://www.coilmaster.com)